



- Warning**
- Ask a qualified installer or contractor to install this product. Do not try to install the product yourself. Improper installation can result in water or refrigerant leakage, electrical shock, fire or explosion.
 - Use only those parts and accessories supplied or specified by Daikin. Ask a qualified installer or contractor to install those parts and accessories. Use of unauthorised parts and accessories or improper installation of parts and accessories can result in water or refrigerant leakage, electrical shock, fire or explosion.
 - Read the user's manual carefully before using this product. The user's manual provides important safety instructions and warnings. Be sure to follow these instructions and warnings.

If you have any enquiries, please contact your local importer, distributor and/or retailer.

Cautions on product corrosion

1. Air conditioners should not be installed in areas where corrosive gases, such as acid gas or alkaline gas, are produced.
2. If the outdoor unit is to be installed close to the sea shore, direct exposure to the sea breeze should be avoided. If you need to install the outdoor unit close to the sea shore, contact your local distributor.

Dealer

PT. DAIKIN AIRCONDITIONING INDONESIA

HEAD OFFICE :
 Wisma KEIAI 18th Floor
 Jl. Jendral Sudirman Kav. 3, Jakarta Pusat 10220
 Telp : +6221 5724 377
 Fax : +6221 5724 366/55
 Website : www.daikin.co.id



SERVICE AND SPARE PARTS, Telp.: 021-736 92899 • **Training Center,** Telp. : 021-295 61950 • **Bekasi,** Telp.: 021-2945 0585,
Tangerang, Telp.: 021-5314 1195 • **Bandung,** Telp.: 022-5225 150 • **Semarang,** Telp.: 024-841 2695 • **Yogyakarta,** Telp.: 0274-551 321
Surabaya, Telp.: 031-503 1138 • **Denpasar,** Telp.: 0361-900 5514 • **Makassar,** Telp.: 0411-446 263 • **Palembang,** Telp.: 0711-319 776
Pekanbaru, Telp. : 0761-561139

Daikin Contact Center : 0800 1 081 081 (Toll Free)

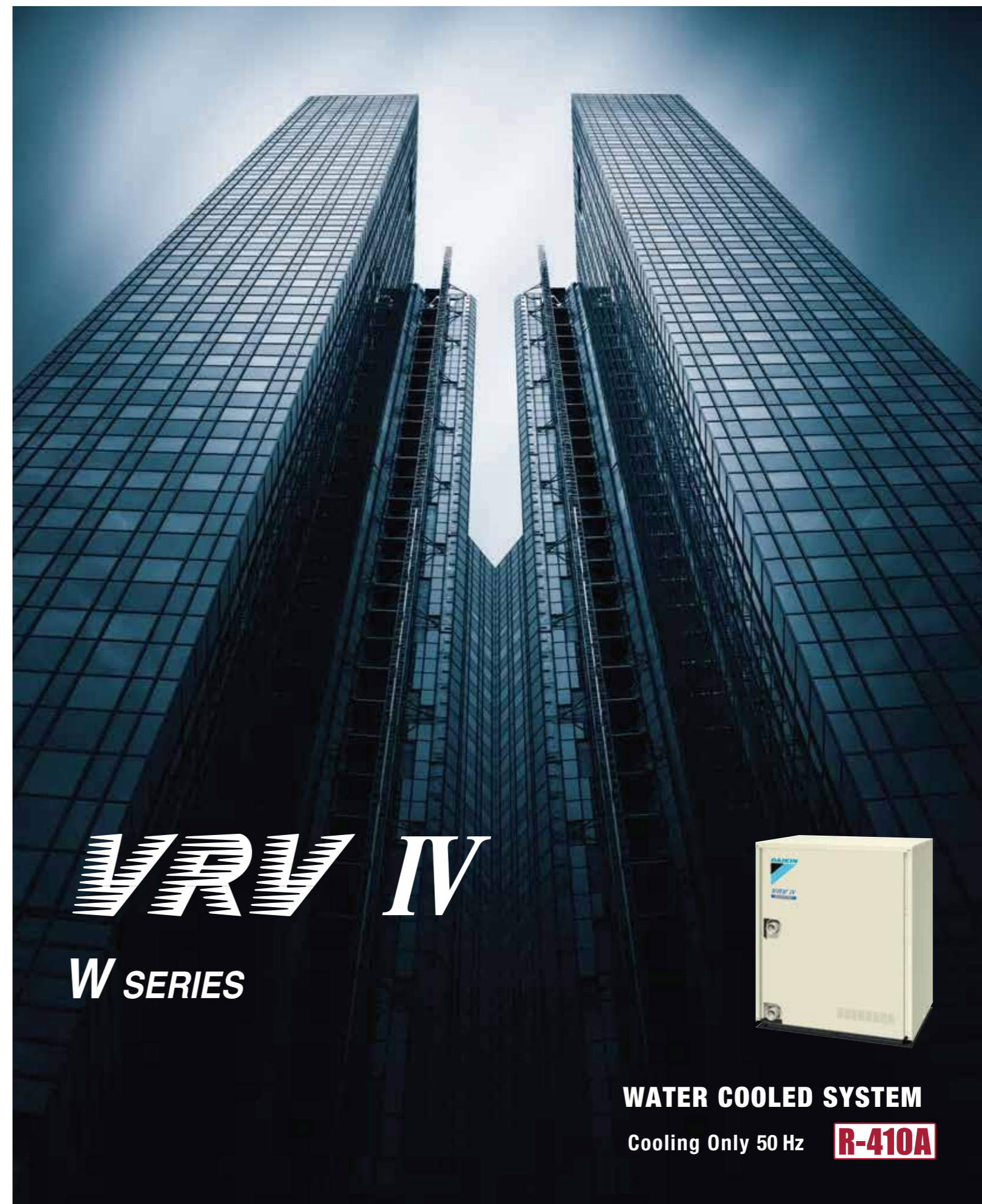

VRV IV

W SERIES



WATER COOLED SYSTEM

Cooling Only 50 Hz

R-410A

A water cooled intelligent individual air conditioning system suitable for tall multi-storey buildings.

VRV IV
W SERIES



What is a water cooled system?

While an air cooled air conditioning system is designed to exchange heat recovered from indoors with outdoor air, a water cooled air conditioning system is designed for heat exchange with water.

Air cooled system

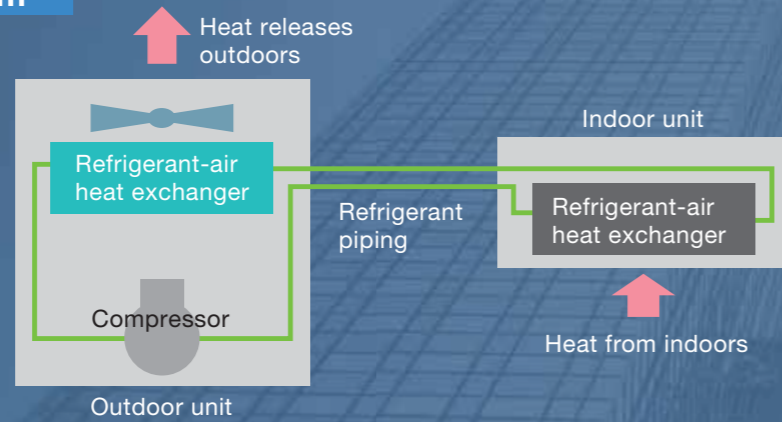

Water cooled system

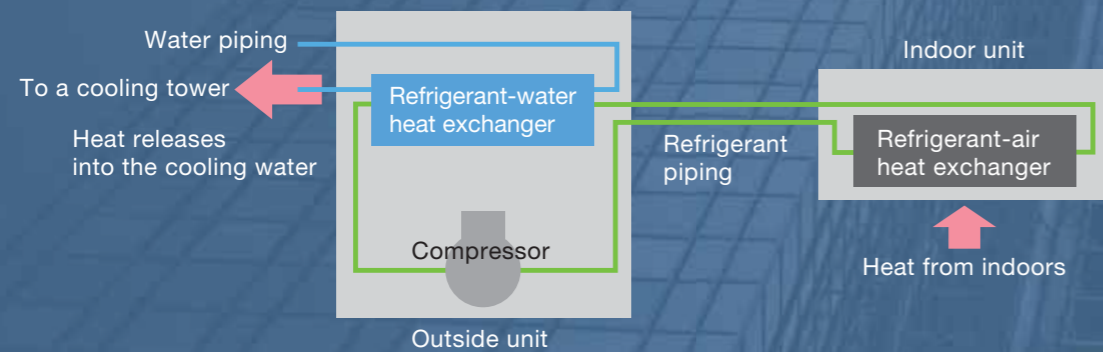

As a water cooled system does not require to exchange heat with outdoor air,

- Outside units can be installed indoors, for example, on basement floors.
→ **High installation flexibility**
- The air conditioning operation is stable even when the outdoor air temperature is high.
→ **Improved comfort**

The VRV IV W series combines the characteristics of a water cooled system with the VRV system.

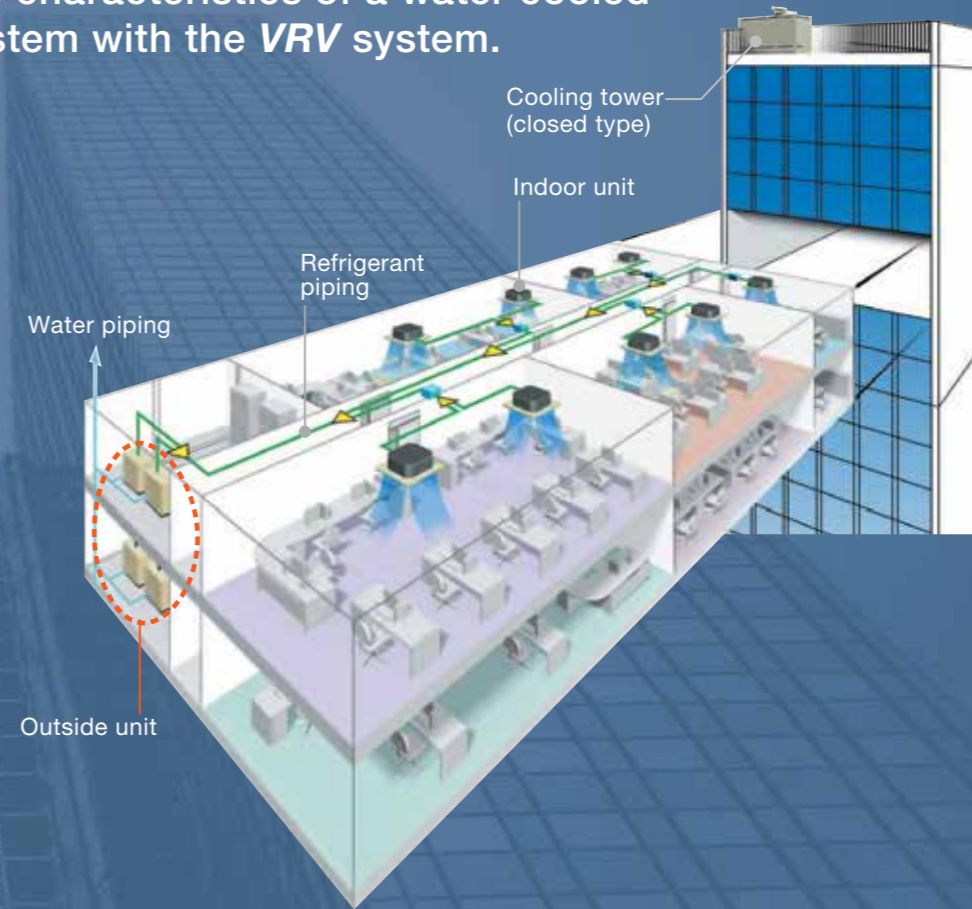

- Individual air conditioning is achieved via on-demand operation in each room.
- Outside units can be installed anywhere in a building if they can be connected with water piping.
- The length of the refrigerant piping can be minimized by installing outside units in proximity to indoor units.
[The system can easily fit into long building floors.]
[The system helps reduce energy loss caused by long refrigerant piping.]
- Refrigerant piping is connected to indoor units.
This design helps reduce the risks of indoor water leakage.

INDEX

Main Features

P3

Indoor Unit Lineup

P19

Specifications

P44

Option List

P59

Control Systems

P65

Air Treatment Equipment Lineup

P77

Air Handling Unit

P94

Enhanced lineup

Wide capacity range from 6 to 36 HP

Easy installation

Compact & lightweight design

Energy saving

Higher COP & VRT technology

Enhanced usability

Centralised interlocking function

The **VRV IV W** series can meet various air conditioning needs by taking full advantage of the characteristics of a water cooled system.

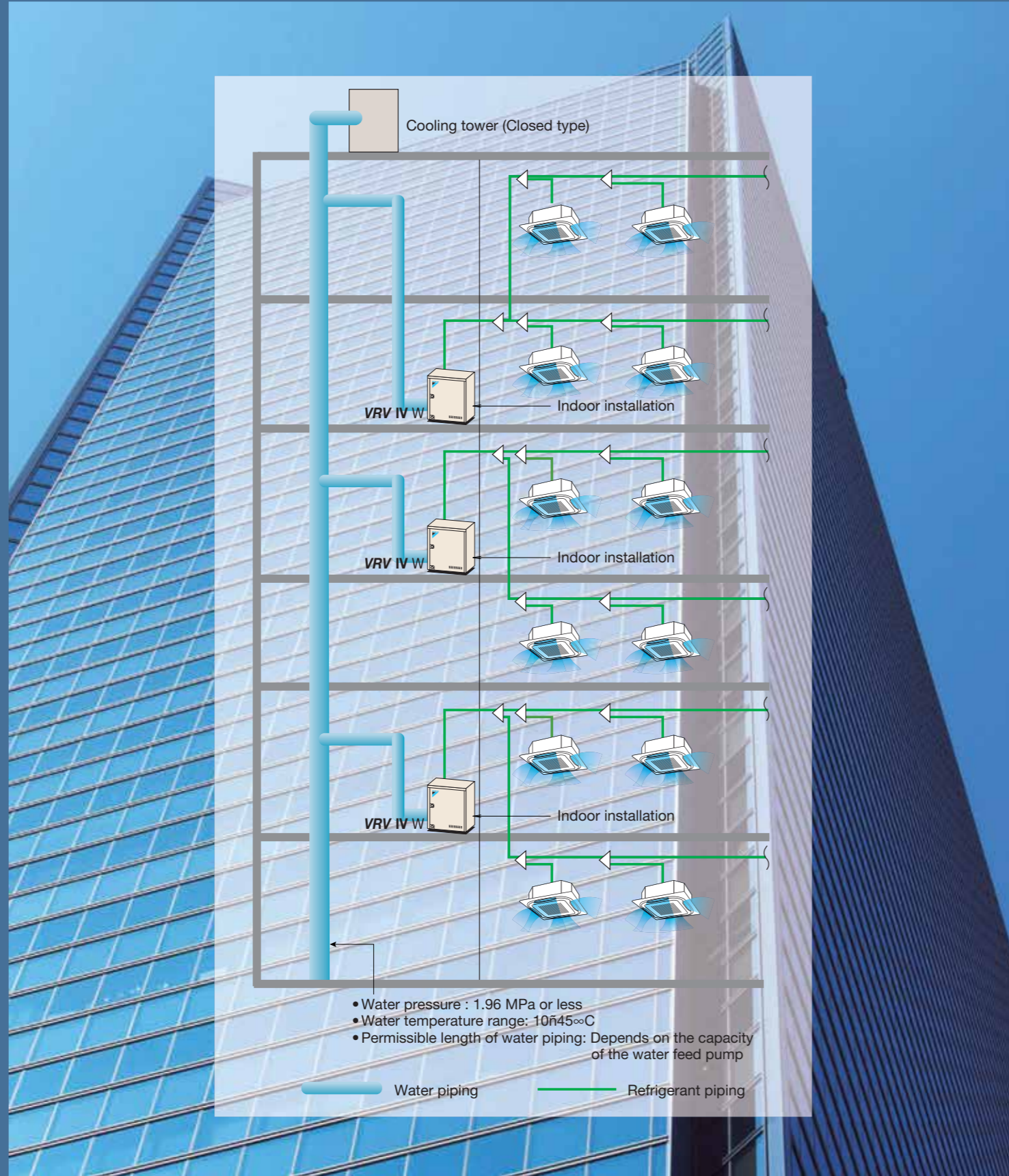

- Water pressure : 1.96 MPa or less
- Water temperature range: 10~45°C
- Permissible length of water piping: Depends on the capacity of the water feed pump

Water piping Refrigerant piping

No balcony required

Adaptable to high-rise buildings due to easy installation on each floor

Compact outside units can be easily installed in the machine rooms on each floor. This helps overcome the restriction on differences in height of refrigerant piping. Individual air conditioning can be easily provided in high-rise buildings using this **VRV** system.

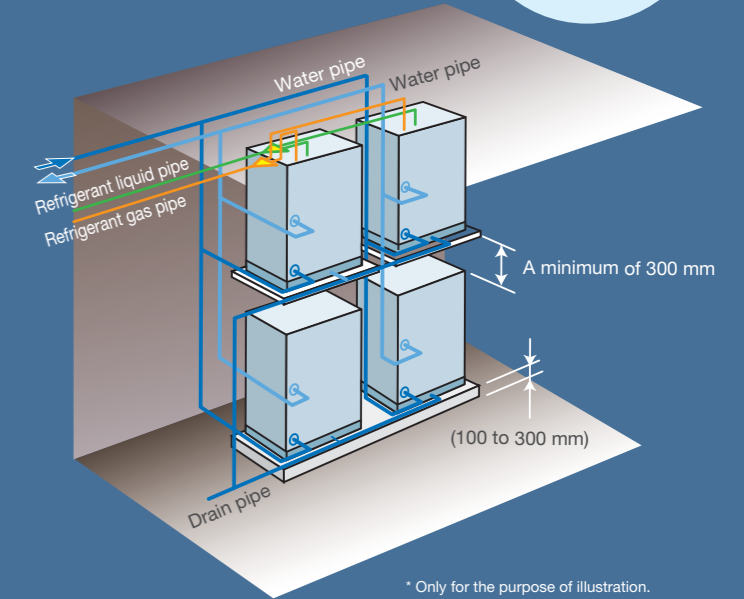
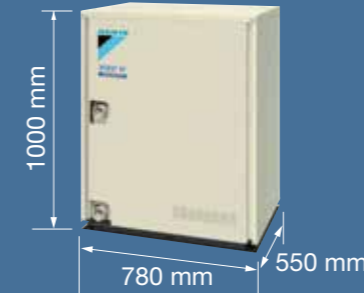

Main Features

Easy to install in underground shopping malls and subway systems

Individual air conditioning can be easily provided in underground shopping malls, subway systems, etc. using this **VRV** system because heat exchange with outdoor air is not required.

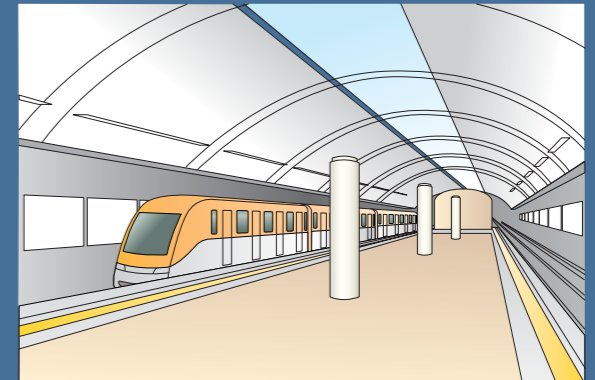

Also recommended for condominiums and detached houses

We offer an extensive lineup of small capacity outside units as well as connectable residential indoor units for detached houses. Compact outside units can be installed indoors.

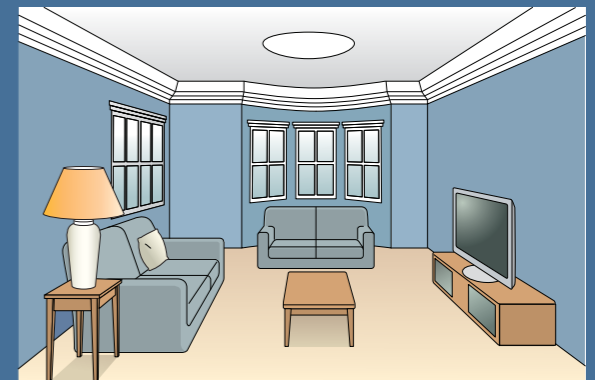

Renovation of an Air Conditioning System

Problems occur for old conventional water system

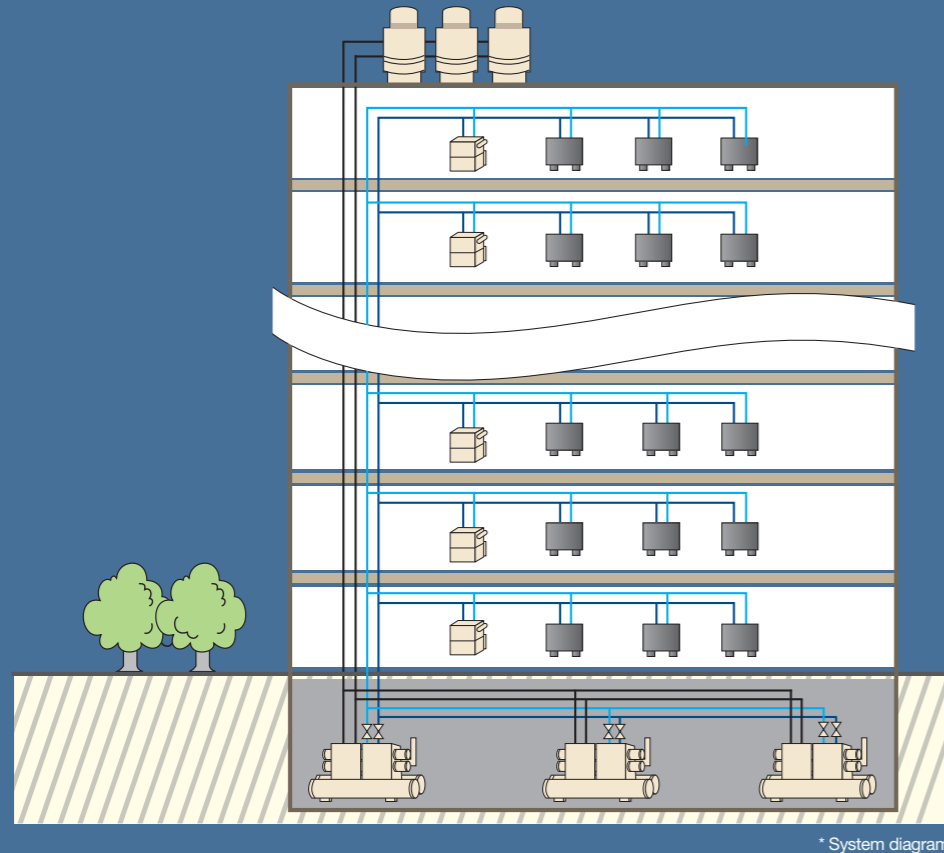

Why is renovation necessary?

- 1 As equipment ages, its air conditioning capacity weakens with each passing year.
- 2 With frequent breakdowns in the outside unit, normal use of air conditioners is unachievable.
- 3 The maintenance cost for the equipment keeps rising.
- 4 The longer the equipment serves, its noise becomes louder.
- 5 Scale formed in water pipes is hard to clean, accelerating corrosion and aging processes.
- 6 To meet the requirements of a 24-hour running IT room is out of the question.
- 7 To cater to new tenants' partitioning changes in a timely manner is difficult.
- 8 To charge by household is not possible.
- 9 To serve tenants working overtime is difficult.
- 10 Central control and management costs too much.



Thorny issues in renovation?

- | | |
|--|---|
| 1 How to avoid damaging the building structure? | 4 How to securely transport the air conditioning outside unit without incident? |
| 2 How to reduce the impact on tenants during renovation? | 5 How to simplify maintenance of the air conditioning system? |
| 3 How to bring the renovation costs down to lowest level possible? | |



A Flexible System Convenient for Expansion/Renovation

Problems with existing water systems can be solved with minimal construction work.

1 Indoor installation solves the puzzle of proper placement of outdoor units

The outside units of the water cooled **VRV IV W** series rid off the need of direct heat exchange with outdoor air. This feature makes it possible to place the outside unit room inside the building, which greatly extends design flexibility and makes it easier to adapt to different types of buildings and open to various kinds of creative building exteriors.

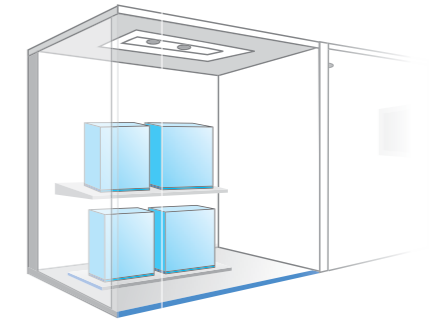

2 Part of the old system can be retained for cost reduction

The water cooled **VRV IV W** series can retain the cooling tower of the old system during renovation, effectively keeping costs down.

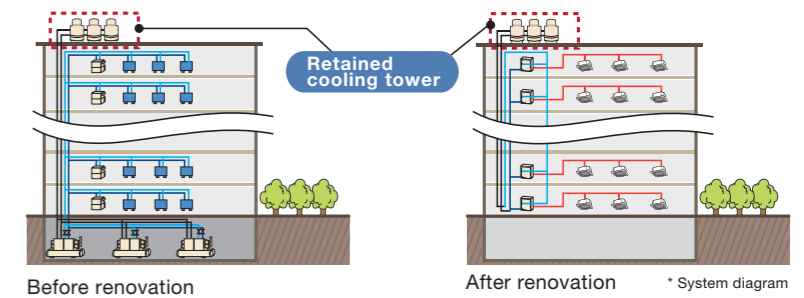

3 The compact outside units facilitate the renovation process and saves space on the outside unit room

- The outside units of the water cooled **VRV IV W** series are conveniently compact, which not only enables transport by elevator possible, but also effectively simplifies installation. This also saves a great deal of time and labor.

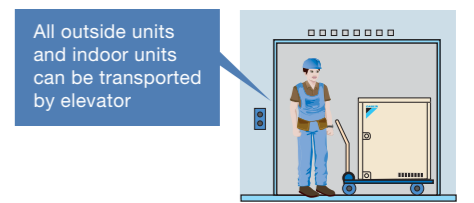

- The modular design featured by the water cooled **VRV IV W** series enables a free and flexible configuration of the outside units. Outside units can be arranged with one on top of another, saving space for other purposes.

Stacking up of the outside units

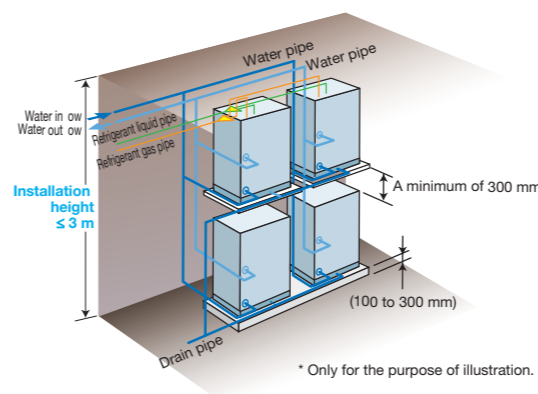

Saving more space for other purposes

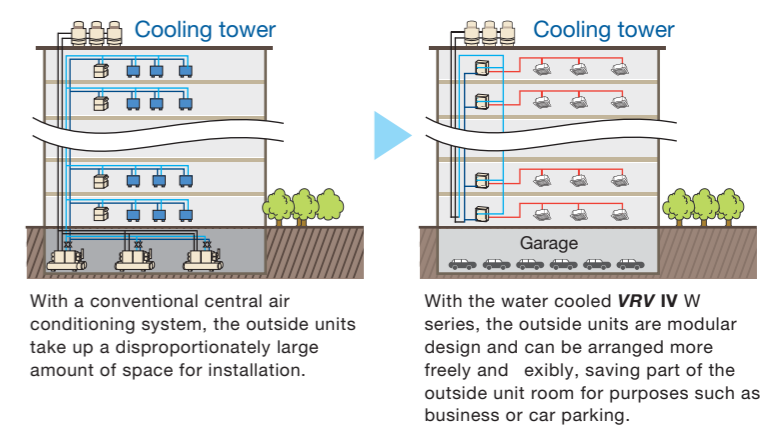

With a conventional central air conditioning system, the outside units take up a disproportionately large amount of space for installation.

With the water cooled **VRV IV W** series, the outside units are modular design and can be arranged more freely and flexibly, saving part of the outside unit room for purposes such as business or car parking.

Renovation of an Air Conditioning System

4 Floor by floor renovation without disturbing other tenants

Based on the actual situation, renovation work can be carried out in phases, lot by lot and floor by floor. This truly and properly gives expression to the outstanding flexibility of the water cooled **VRV IV W** series.

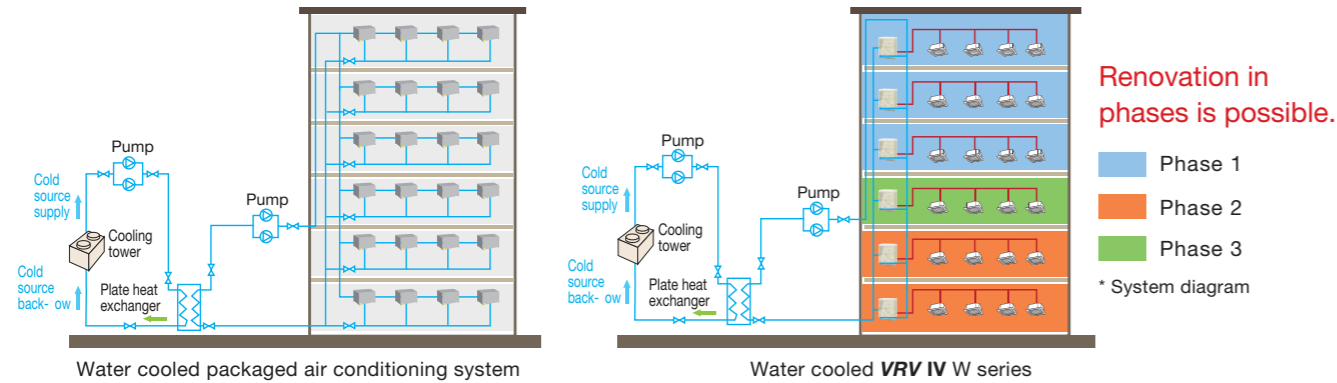

5 Compact refrigerant pipes and VRV indoor units help to save ceiling space

The outside units and indoor units of the water cooled **VRV IV W** series are connected by refrigerant pipes. As the **VRV** indoor units and the diameter of refrigerant pipes are significantly smaller than duct and water pipes, less ceiling space is occupied and more floor height is saved. Less work is needed for expansion and renovation of the air conditioning system, thus minimizing the influence on other tenants.



Individual air conditioning comfort can be realized when and where it is actually required.

1 Independent control provides greater comfort and convenience

Each indoor unit of the water cooled **VRV IV W** series can be independently controlled and adjusted according to each tenant's individual needs for temperature and air volume. This achieves optimal comfort and convenience.

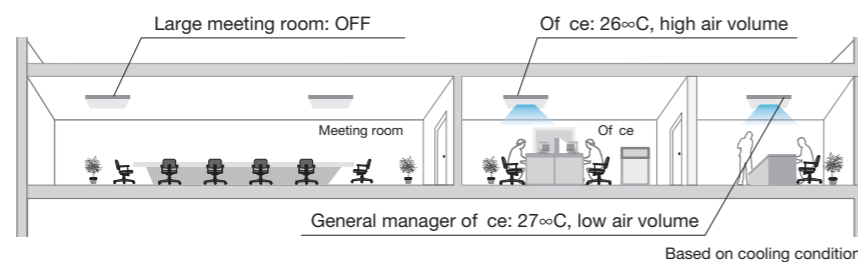

2 Higher efficiency with partial load

In actual operation, an air conditioning system's load may vary due to external climate change or variation of indoor unit operation rate, making the air conditioning system work in a partial load operation most of the time. By virtue of Daikin's advanced DC inverter technology and advanced refrigerant control technology, the water cooled **VRV IV W** series boasts a higher efficiency in a partial load state than in the rated operating conditions.

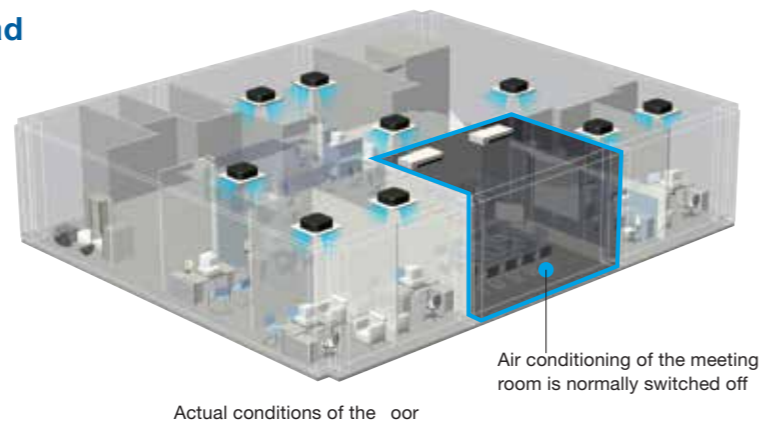

3 Flexibly satisfies conditions for working overtime and times of insufficient load

When teaming up with a conventional central air conditioning system, the water cooled **VRV IV W** series can easily handle the air conditioning needs for working after-hours while the building's central air conditioner can be utilized during normal work hours. The water cooled **VRV IV W** series can be added according to actual needs.

- Cumbersome application procedures are eliminated, and the tenants' daily air conditioning costs decrease.
- Based actual schedules, operation for each indoor unit can be precisely and individually set.

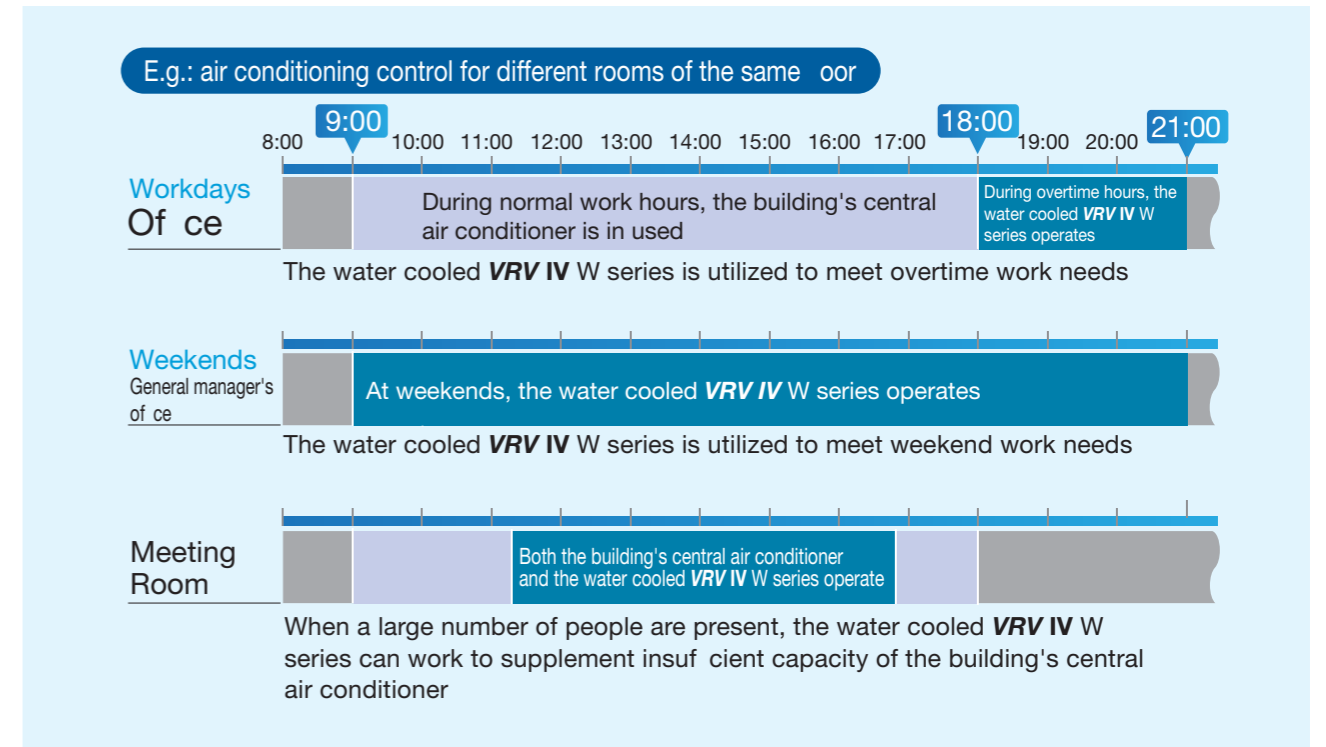

4 Connection using refrigerant pipes eliminate the risk of water leakage

The outside units and indoor units of the water cooled **VRV IV W** series are connected by refrigerant pipes, with water pipes centralised in the outside unit room and the pipe well. This arrangement greatly reduces the risk of damage of important equipment indoors caused by water leakage of the system.

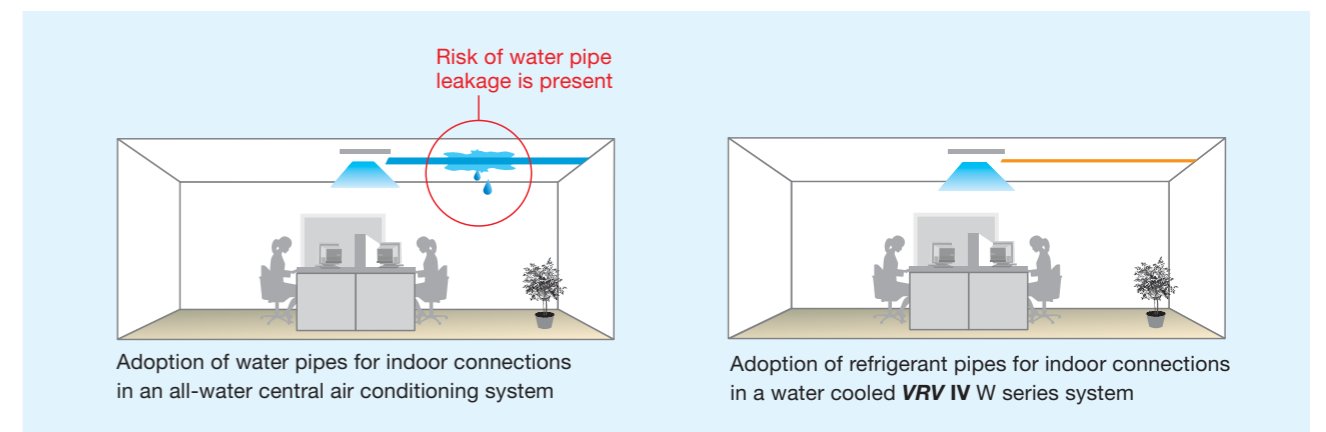

Easy installation

Compact and lightweight

Adoption of a water heat exchanger and optimisation of the refrigerant control circuit has resulted compact and lightweight equipment. A weight of 146 kg and height of 1,000 mm make installation possible in buildings with limited space, or where no space is available for outdoor units. This makes the system ideal for places that have no area outside—such as underground malls.

* The unit is designed for indoor installation only.



VRV III W series
24 HP(8 HP+8 HP+8 HP)



VRV IV W SERIES
24 HP(12 HP+12 HP)



Footprint	1.29 m ²	→	0.86 m ²	33% Decrease
Product Weight	447 kg	→	294 kg	34% Decrease

Enhanced usability

Centralised interlocking function

Centralised interlocking input is possible using an external control adaptor (DTA104A62).

By using one external control adaptor circuit board, centralised interlocking input to multiple units within the same water system is possible.

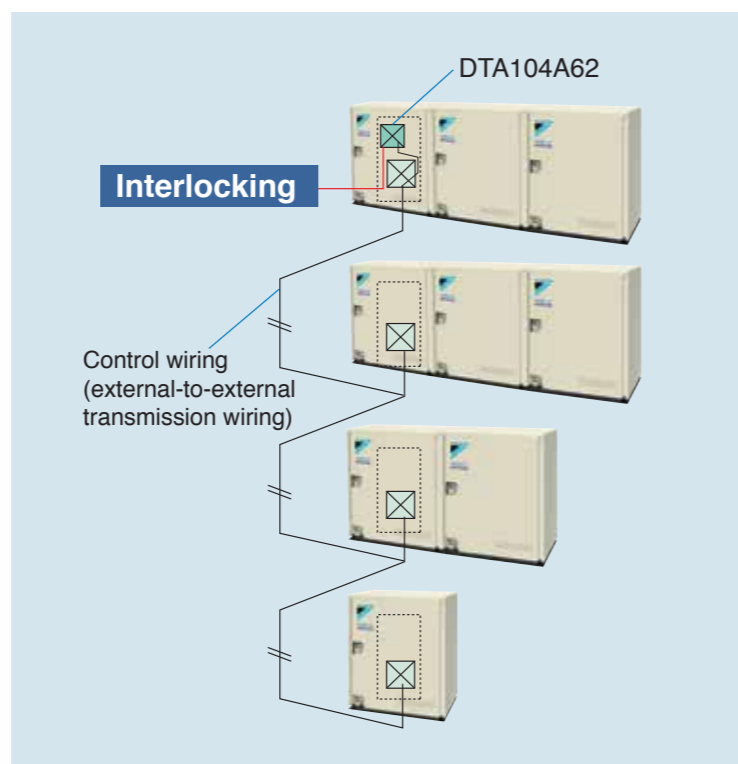

Enhanced lineup

Wider capacity range from 6 to 36 HP

With its enhanced lineup of 2 new models-6 HP and 12 HP single outside units, **VRV IV W** series offers a wider capacity range from 6 HP to 36 HP to meet an ever wider variety of needs.

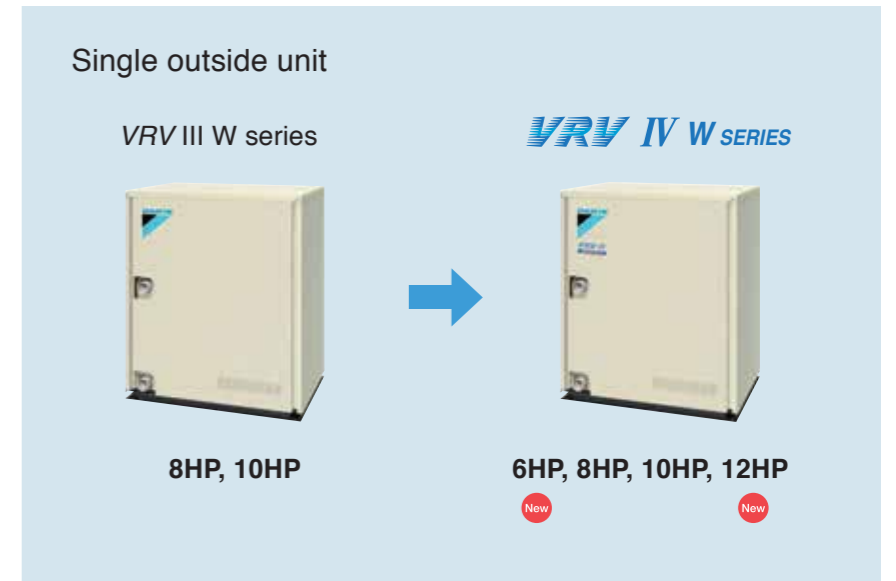

VRV IV W SERIES

6,8,10,12 HP	14,16,18,20,22,24 HP	26,28,32,34,36 HP
 New RWEYQ6TYM RWEYQ8TYM	 RWEYQ10TYM New RWEYQ12TYM	 RWEYQ14TYM RWEYQ16TYM RWEYQ18TYM RWEYQ20TYM New RWEYQ22TYM RWEYQ24TYM RWEYQ26TYM RWEYQ28TYM RWEYQ30TYM New RWEYQ32TYM New RWEYQ34TYM New RWEYQ36TYM

Mo/C New Lineup

Capacity Range	HP	6	8	10	12	14	16	18	20	22	24	26	28	30	32	34	36
	kW	16.0	22.4	28.0	33.5	38.4	44.8	50.4	56.0	61.5	67.0	72.8	78.4	84.0	89.4	95.0	101
Conventional model VRV III W series			Mo/C	Mo/C			Mo/C	Mo/C	Mo/C		Mo/C	Mo/C	Mo/C	Mo/C			
VRV IV W SERIES		New Lineup	Mo/C	Mo/C	New Lineup	New Lineup	Mo/C	Mo/C	Mo/C	New Lineup	Mo/C	Mo/C	Mo/C	Mo/C	New Lineup	New Lineup	New Lineup

Energy saving

Higher Coefficient of Performance (COP)

It has become essential for air conditioning manufacturers to develop systems that provide high energy savings. We at Daikin have made great efforts in this field, and the **VRV IV W** series delivers highly efficient performance, contributing to high energy savings.

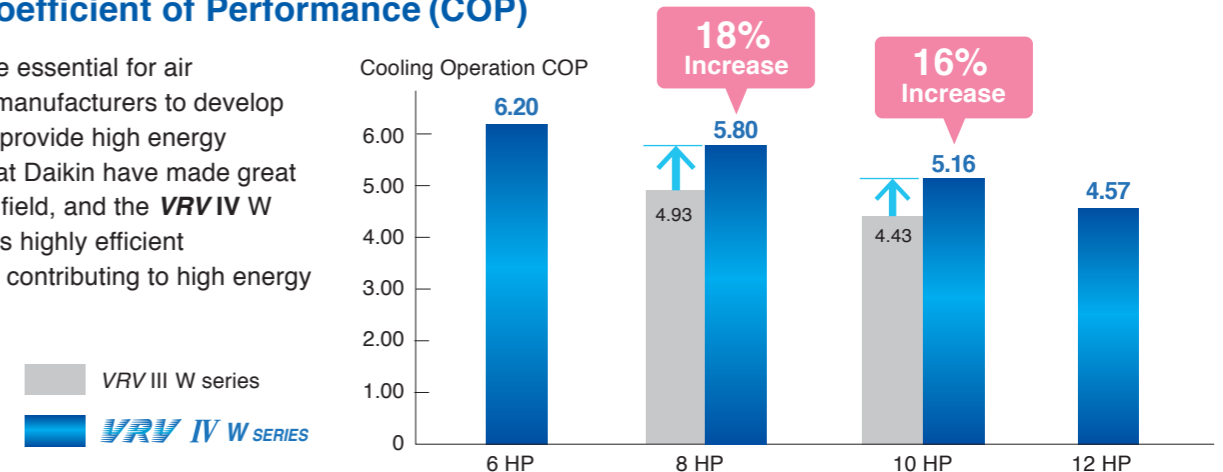

*Cooling : Indoor temp.: 27°CDB, 19°CWB/inlet water temp.: 30°C, Equivalent piping length: 7.5 m, Level difference: 0 m.

State-of-the-art energy saving technology

Customise your VRV for optimal annual efficiency

The new VRV IV W series now features VRT technology. VRT automatically adjusts refrigerant temperature to individual building and climate requirement, thus further improving annual energy efficiency and maintaining comfort. With this excellent technology, running costs are reduced.



How is energy reduced?

During cooling, the refrigerant evaporating temperature (T_e) is raised to minimise the difference with the condensing temperature. Compressors work less, and this reduces power consumption.

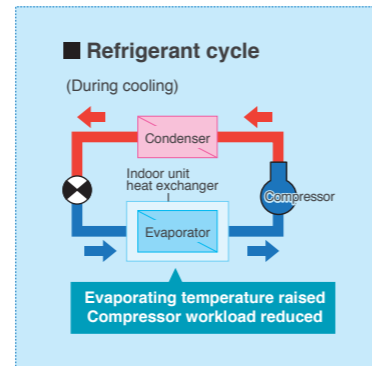

Typical changes in evaporating temperature and COP depending on changing indoor load

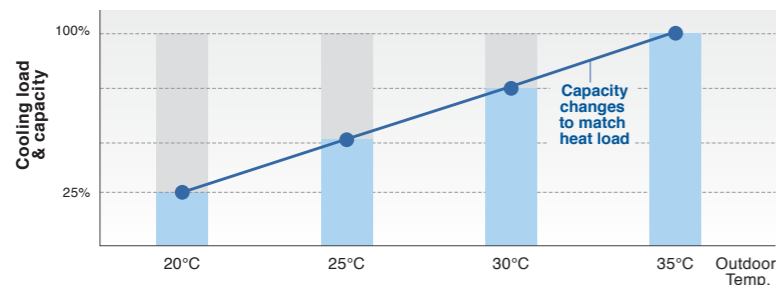

Required capacity changes as air conditioning load changes according to outdoor temperature.

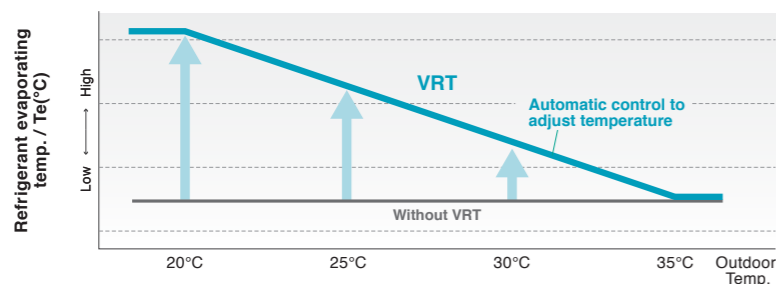

In case of fixed evaporating temperature, excessive cooling, thermo on-off loss, and other inefficiencies occur.

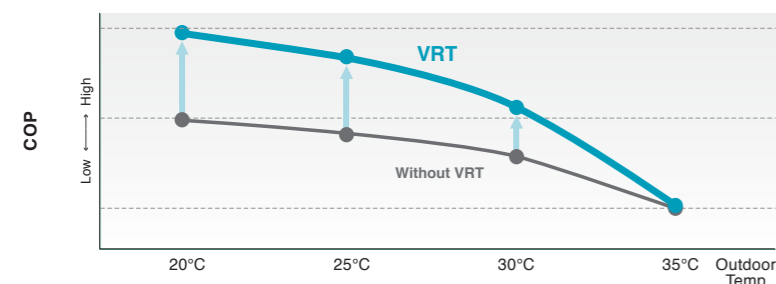

Automatic control adjusts evaporating temperature to heat load change.

Energy efficiency is improved without sacrificing comfort.

Fine control to match user preference available through mode selection

Basic mode is selected to maintain optimal comfort. VRT is selected to save energy and prevent excessive cooling.

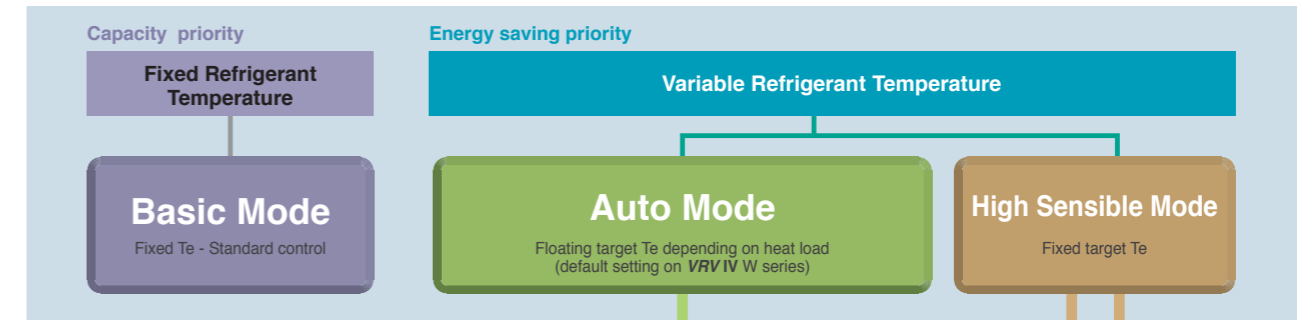

Selecting VRT enables operation to be optimised for either energy efficiency or rapid cooling.

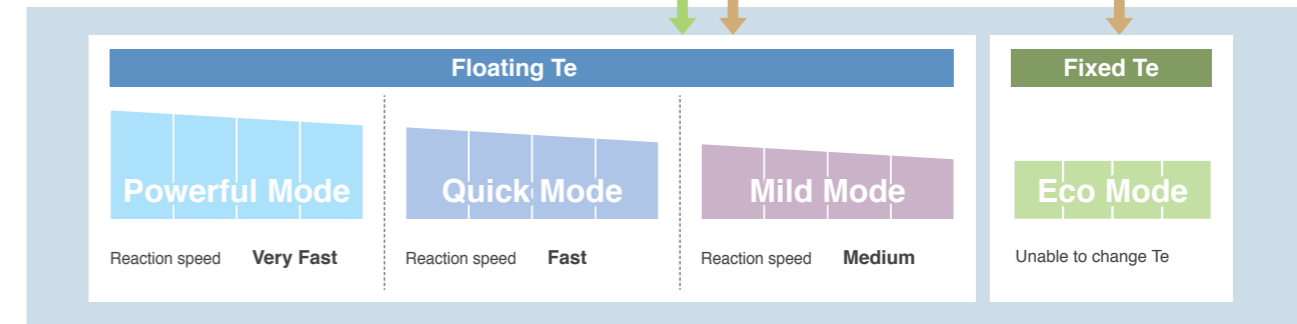

VRT offers quicker cool down to shorten uncomfortable pull down time.

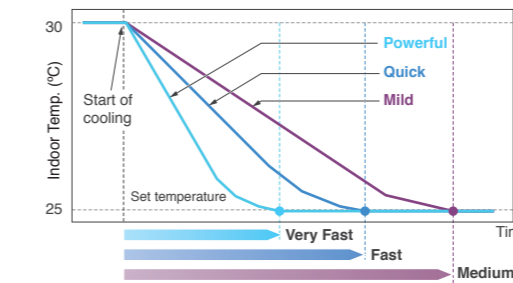

Powerful mode	<ul style="list-style-type: none"> Can boost capacity above 100% if needed. The refrigerant temperature can go lower in cooling than the set minimum. Gives priority to very fast reaction speed. The refrigerant temperature goes down fast to keep the room setpoint stable.
Quick mode	<ul style="list-style-type: none"> Gives priority to fast reaction speed. The refrigerant temperature goes down fast to keep the room setpoint stable.
Mild mode	<ul style="list-style-type: none"> Gives priority to efficiency. The refrigerant temperature goes down gradually giving priority to the efficiency of the system instead of the reaction speed.

Recommended for use in these situations

Cooling only regions having differences in daily temperature.

VRT is particularly effective at night when temperatures are low.

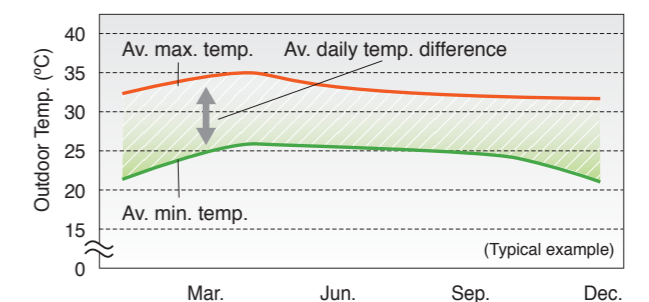

Long refrigerant piping length

Within the refrigerant piping system, a maximum of 120 m of actual piping length and 50 m of level difference between the VRV IV W series and indoor units are possible. Water piping does not enter occupied spaces, so there is little chance of water leaking.

For connection of only VRV indoor units.

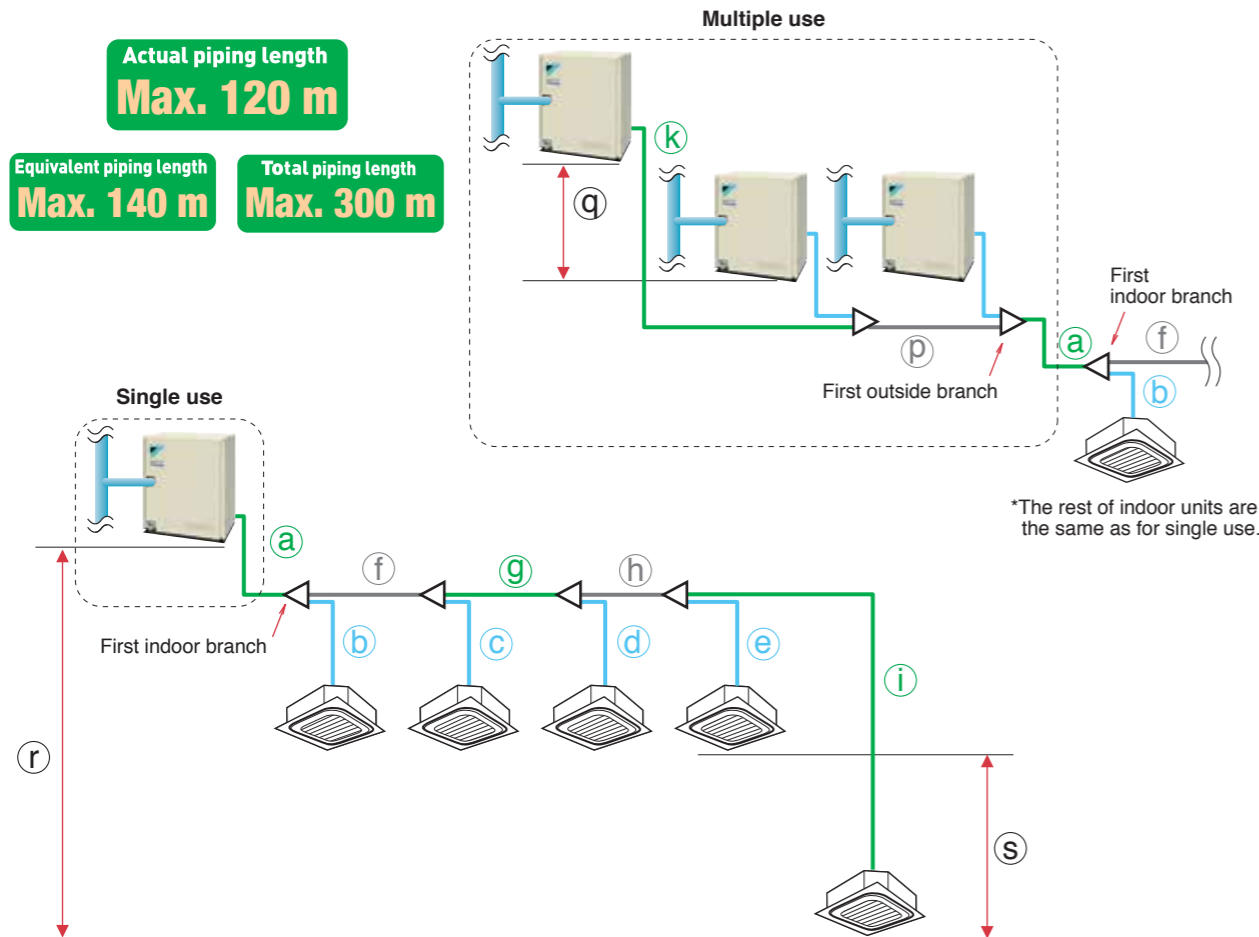

* Colours in the diagram above are merely for identifying pipes referenced with symbols such as @.

		Actual piping length	Example	Equivalent piping length	
Max. allowable piping length	Refrigerant piping length	120 m	$a + f + g + h + i$	140 m	
	Total piping length	300 m	$a + b + c + d + e + f + g + h + i$	—	
	Between the first indoor branch and the farthest indoor unit	90 m^{*1}	$f + g + h + i$	—	
	Between the first outside branch and the last outside unit	10 m	$k + p$	13 m	
Max. allowable level difference	Between the outside units (multiple use)	2 m	q	—	
	Between the indoor units	15 m	s	—	
	Between the outside units and the indoor units	If the outside unit is above.	50 m	r	—
		If the outside unit is below.	40 m	r	—

*1 No special requirements up to 40 m. The maximum actual piping length can be 90 m, depending on conditions. Various conditions and requirements have to be met to allow utilisation of 90 m piping length. Be sure to refer to the Engineering Data Book for details of these conditions and requirements.

For connection of only residential indoor units.

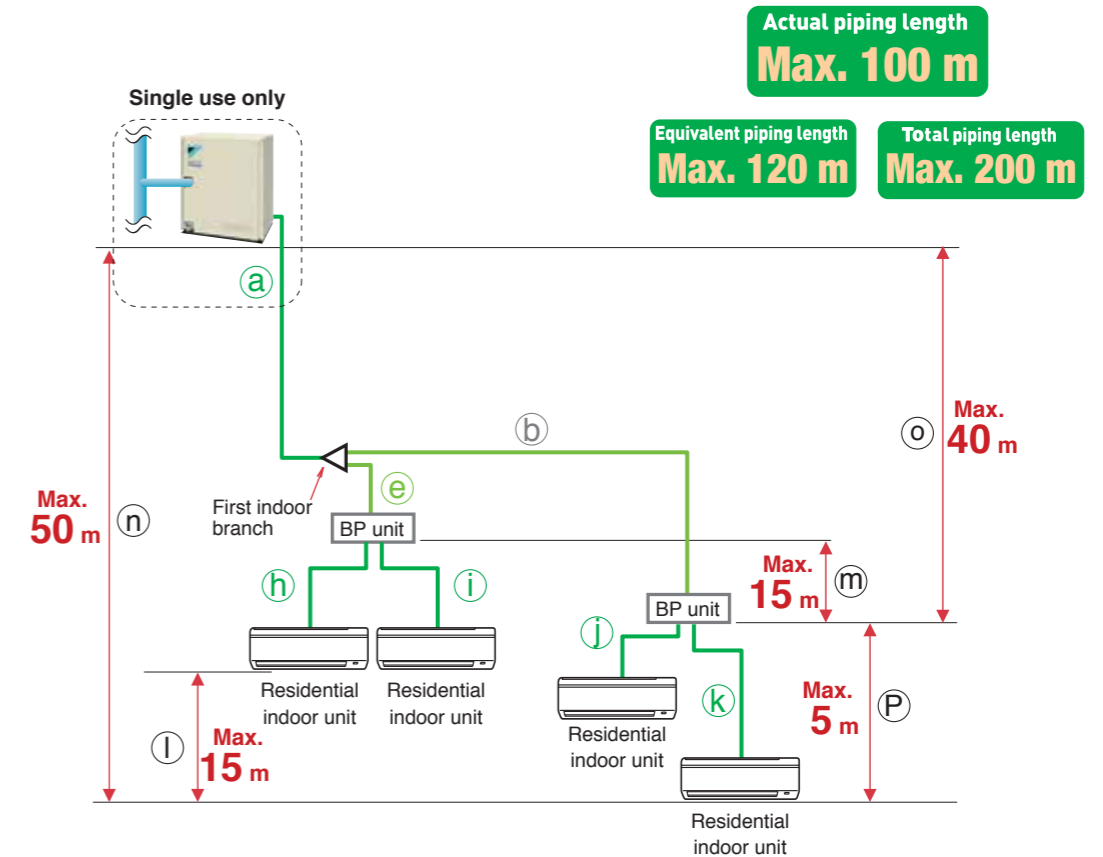

* Colours in the diagram above are merely for identifying pipes referenced with symbols such as @.

		Actual piping length	Example	Equivalent Example piping length
Max. allowable piping length	Refrigerant piping length	100 m	$a + b + k$	120 m
	Total piping length	200 m	$a + b + e + h + j + k$	—
	Between the first indoor branch and the farthest indoor unit	50 m^{*1}	$b + k$	—
Max. and min. allowable piping length	Between BP unit and indoor unit	If indoor unit capacity index < 60	$2\text{ m} - 15\text{ m}$	h, i, j, k
		If indoor unit capacity index is 60	$2\text{ m} - 12\text{ m}$	h, i, j, k
		If indoor unit capacity index is 71	$2\text{ m} - 8\text{ m}$	h, i, j, k
Max. allowable level difference	Between the outside unit and the indoor unit	If the outside unit is above.	50 m	n
		If the outside unit is below.	40 m	n
	Between the indoor units	15 m	l	
	Between the outside unit and the BP unit	40 m	o	
	Between the BP unit and the indoor unit	5 m	p	

*1. When the piping length exceeds 20 m, the size of the main pipes (the gas side and the liquid side) must be increased. Please refer to Engineering Data Book for details.

High efficiency compressor to achieve a high COP

Compressor equipped with Reluctance DC motor

Daikin DC inverter models are equipped with the Reluctance DC motor for compressor. The Reluctance DC motor uses 2 different types of torque, neodymium magnet*1 and reluctance torque*2. This motor can save energy because it generates more power with a smaller electric power than an AC or conventional DC motor.

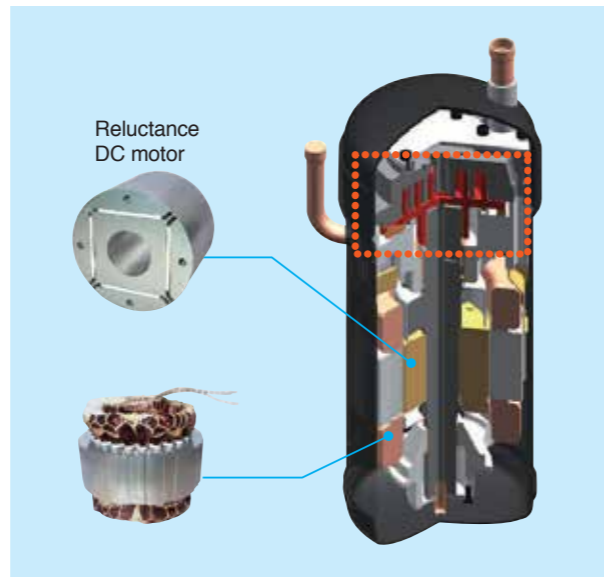
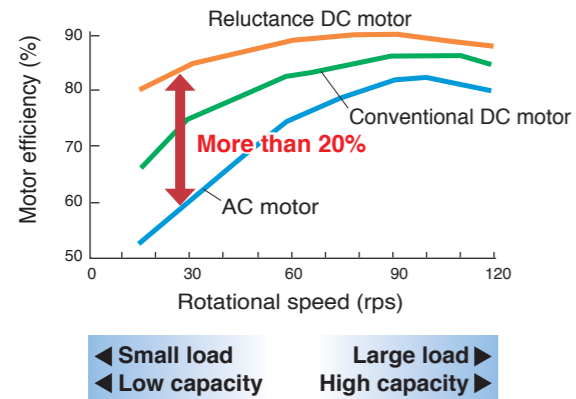

Note: Data are based on studies conducted under controlled conditions at a Daikin laboratory using Daikin products.

*1 A neodymium magnet is approximately 10 times stronger than a standard ferrite magnet.

*2 The torque created by the change in power between the iron and magnet parts.

Smooth sine wave DC inverter

Use of an optimised sine wave smoothes motor rotation, further improving operating efficiency.

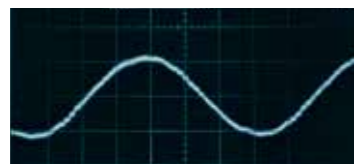

Sine wave DC inverter

Scroll compressor

Sucked gas is compressed in the scrolling part before the heated motor, so that the machine compresses the non-expanded gas, resulting in high efficiency compression.

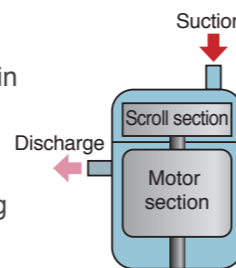

Advanced control main PC board

SMT* packaging technology

- SMT packaging technology adopted by the whole computer control panel improves the anti-clutter performance.
- Protects your computer boards from the adverse effect of sandy and humid weather.

*SMT: Surface mounted technology

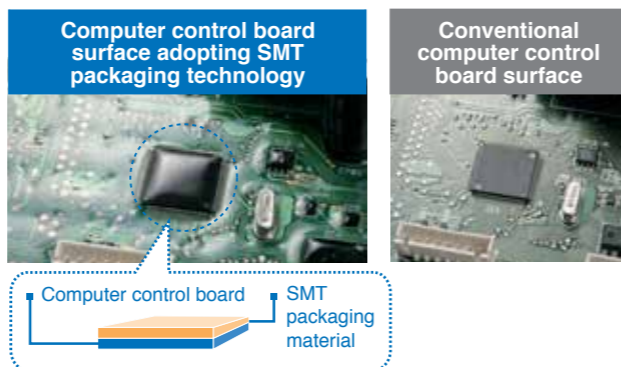

Minimize performance degradation from refrigeration oil in all stages of operation

Newly designed oil receiver

Adding a container vessel (Oil Receiver) helps eliminate performance degradation by retaining refrigeration oil and preventing excessive oil from flowing to the heat exchanger. The new design enables the oil receiver to automatically supply the compressor with only the necessary amount of oil.

Conventional VRV III W series

Refrigeration oil discharged from the compressor circulates in the refrigerant cycle and lowers the heat transfer capabilities of the indoor and outside unit heat exchangers.

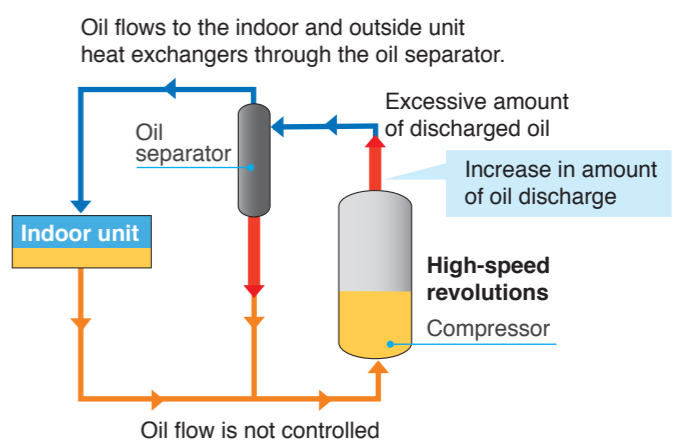
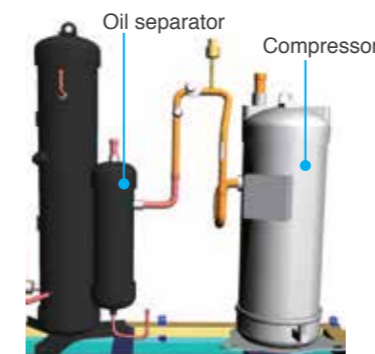

VRV IV W SERIES

Surplus oil is stored in the oil receiver and automatically controls the amount of refrigeration oil in the refrigerant cycle. This prevents a reduction in performance for heat exchanger.

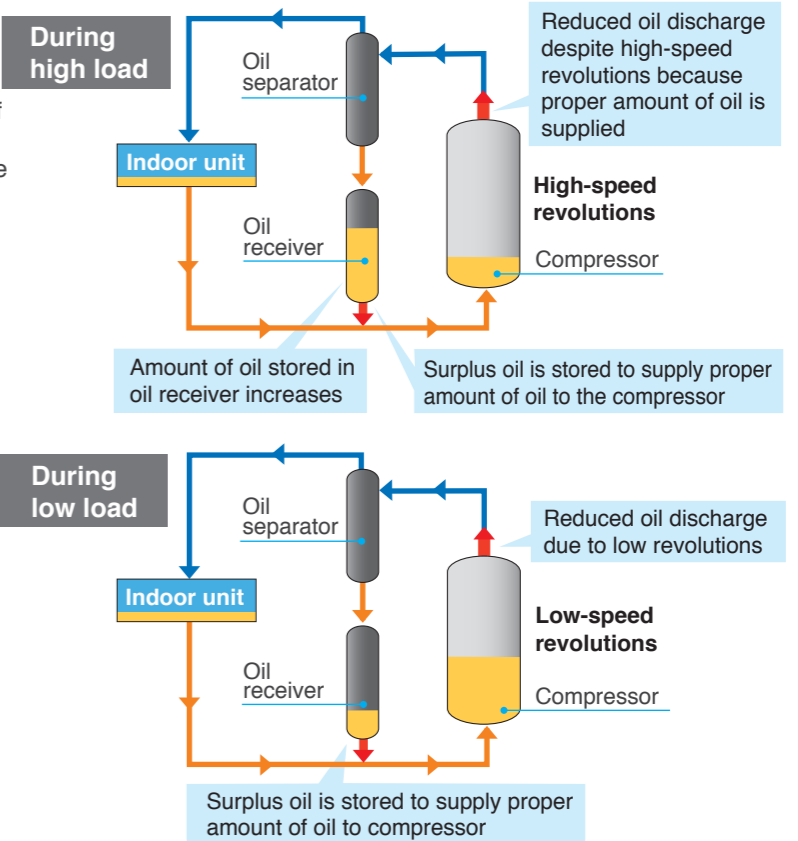
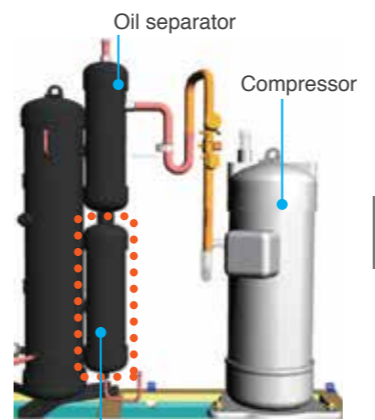

Simplified commissioning and after-sales service

Function of information display by luminous digital tube

VRV IV W series utilises 7-segment luminous digital tubes to display system operation information, enabling the operational state to be visually displayed whilst facilitating simplified commissioning and after-sales service.

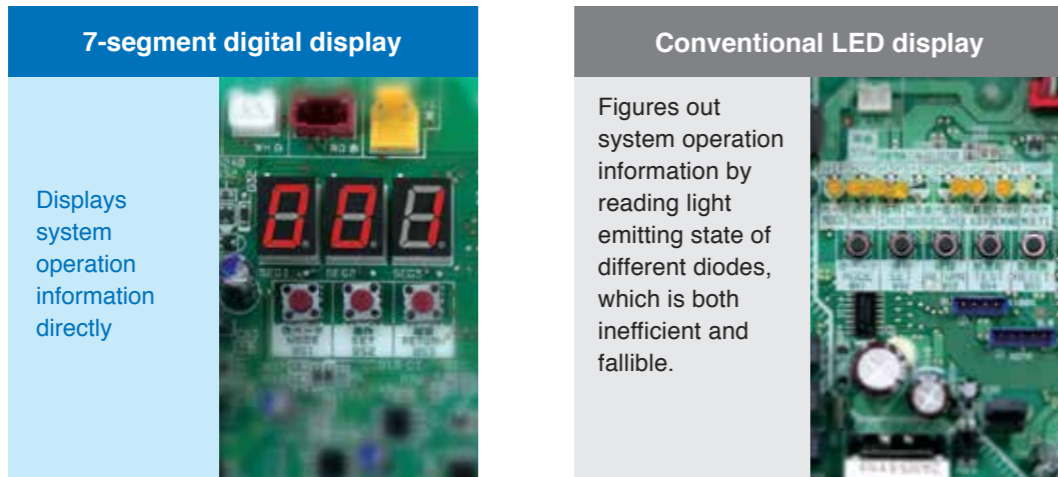

Outside unit sequencing technology

Automatic sequencing operation

During start-up, Daikin VRV IV W series outside unit sequencing operation will be automatically enabled to ensure balanced operation of each outdoor unit to improve longevity of equipment and stable operation.

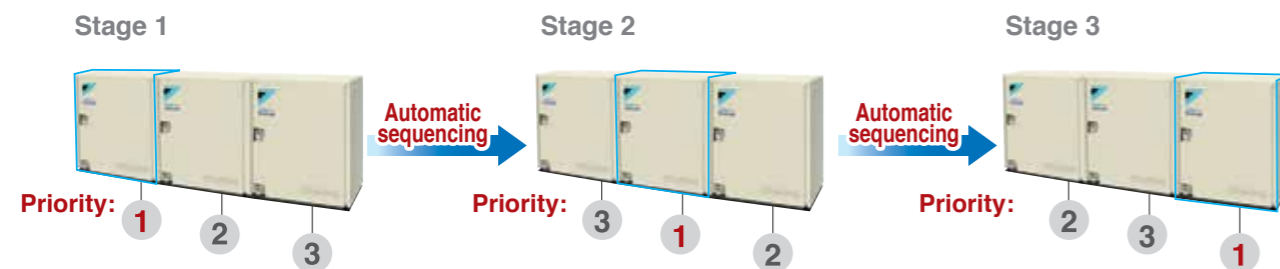

Reliable and convenient air conditioning system

Auto-restart technology after power interruption

No matter whether the indoor or outside unit accidentally experiences a power interruption during normal operation, the system will keep a record of the operating mode adopted before the power interruption. When the power supply recovers, the air conditioning system will then restore itself back into the recorded operating status, simplifying the operation after an accidental power interruption.

Refrigerant pressure detection technology makes system operation more stable and efficient

Quick and accurate detection of the system's refrigerant status is crucial to the stable and efficient operation of the system. The water cooled VRV IV W series not only utilizes temperature sensors to detect the system's operating status, but also employs high and low pressure sensors to carry out a quick, comprehensive and accurate detection of the system's refrigerant status, ensuring more stable and efficient operation.

More stable operation

- Low pressure protection: the system can effectively protect the compressor from being affected by instantaneous low pressure changes through monitoring the pressure data of the air suction pipe. Compared with the conventional low pressure protection method featuring temperature sensors, the pressure-sensor method boasts quicker response and can better reflect the system's instantaneous operating status.

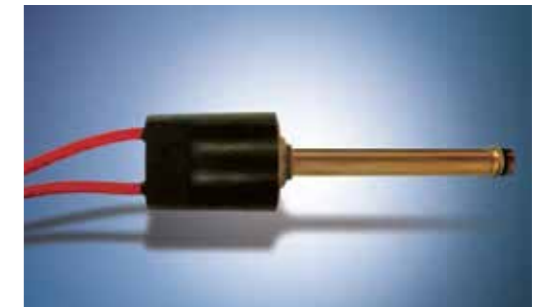

- High pressure protection: the system can also keep the compressor from being affected by instantaneous high pressure changes.

More efficient operation

- A low pressure sensor, together with advanced supercooling technologies and high pressure protection control, helps to realize fast starting of the compressor, and can also quickly adjust rotational speed according to refrigerant status to adjust to indoor load fluctuations more rapidly.

Enhanced range of choices

Indoor units can be selected from 2 lineups, both VRV and residential indoor units, to match rooms and preferences.

VRV indoor units

22 types 108 models

Type	Model Name	Capacity Range	Capacity Index															
			0.8 HP	1 HP	1.25 HP	1.6 HP	2 HP	2.5 HP	3 HP	3.2 HP	4 HP	5 HP	6 HP	8 HP	10 HP	16 HP	20 HP	
			20	25	31.25	40	50	62.5	71	80	100	125	140	200	250	400	500	
Ceiling Mounted Cassette (Round Flow with Sensing)	FXFQ-SVM		●	●	●	●	●	●	●	●	●	●	●	●	●	●		
Ceiling Mounted Cassette (Round Flow)	FXFQ-LUV1		●	●	●	●	●	●	●	●	●	●	●	●	●	●		
Ceiling Mounted Cassette (Compact Multi Flow)	FXZQ-MVE		●	●	●	●	●	●	●	●	●	●	●	●	●	●		
Ceiling Mounted Cassette (Double Flow)	FXCQ-MVE		●	●	●	●	●	●	●	●	●	●	●	●	●	●		
Ceiling Mounted Cassette Corner	FXKQ-MAVE		●	●	●	●	●	●	●	●	●	●	●	●	●	●		
Slim Ceiling Mounted Duct (Standard Series)	FXDQ-PBVE (with drain pump)		●	●	●	●	●	●	●	●	●	●	●	●	●	●		
	FXDQ-PBVET (without drain pump) (700 mm width type)		●	●	●	●	●	●	●	●	●	●	●	●	●	●		
	FXDQ-NBVE (with drain pump)		●	●	●	●	●	●	●	●	●	●	●	●	●	●		
	FXDQ-NBVET (without drain pump) (900/1,100 mm width type)		●	●	●	●	●	●	●	●	●	●	●	●	●	●		
Slim Ceiling Mounted Duct (Compact Series)	New FXDQ-SPV1		New	New	New	New	New	New	New	New	New	New	New	New	New			
Middle Static Pressure Ceiling Mounted Duct	New FXSQ-PVE		New	New	New	New	New	New	New	New	New	New	New	New	New			
Ceiling Mounted Duct	FXMQ-PVE		●	●	●	●	●	●	●	●	●	●	●	●	●	●		
	FXMQ-MAVE		●	●	●	●	●	●	●	●	●	●	●	●	●	●		
Outdoor-Air Processing Unit	FXMQ-MFV1		●	●	●	●	●	●	●	●	●	●	●	●	●	●		
4-Way Flow Ceiling Suspended	FXUQ-AVEB		●	●	●	●	●	●	●	●	●	●	●	●	●	●		
Ceiling Suspended	FXHQ-MAVE		●	●	●	●	●	●	●	●	●	●	●	●	●	●		
Wall Mounted	FXAQ-PVE		●	●	●	●	●	●	●	●	●	●	●	●	●	●		
	FXLQ-MAVE		●	●	●	●	●	●	●	●	●	●	●	●	●	●		
Concealed Floor Standing	FXNQ-MAVE		●	●	●	●	●	●	●	●	●	●	●	●	●	●		
Floor Standing Duct	New FXVQ-NY1		●	●	●	●	●	●	●	●	●	●	●	●	●	●		
	New FXVQ-NY16 (high static pressure type)		●	●	●	●	●	●	●	●	●	●	●	●	●	●		
Air Handling Unit	AHUR		●	●	●	●	●	●	●	●	●	●	●	●	●	●		

Residential indoor units with connection to BP units

6 types 18 models

Type	Model Name	Rated Capacity (kW)	Capacity Index				
			25	35	50	60	71
			2.5	3.5	5.0	6.0	7.1
Slim Ceiling Mounted Duct	FDKS-EAVMB		●	●	●	●	●
	FDKS-C(A)VMB		●	●	●	●	●
Wall Mounted	New FTKJ-NVMW		New	New	New	New	New
	New FTKJ-NVMS		New	New	New	New	New
	FTKS-DVM		●	●	●	●	●
	FTKS-BVMA		●	●	●	●	●
	FTKS-FVM		●	●	●	●	●

Note: BP units are necessary for residential indoor units. Only single outside unit (RWEYQ6-12T) can be connected.

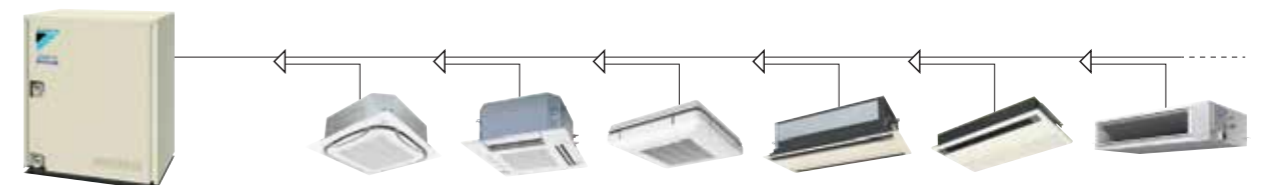

Max. 58 indoor units

VRV indoor units only



Max. 19 indoor units

Residential indoor units only

*Refer to page 56 for the maximum number of connectable indoor units.

Daikin offers a wide range of indoor units includes both VRV and residential models responding to variety of needs of our customers that require air-conditioning solutions.

VRV Indoor Units

Ceiling Mounted Cassette (Round Flow with Sensing) Type

FXFQ-SVM



Presence of people and floor temperature can be detected to provide comfort and energy savings



Ceiling Mounted Cassette (Round Flow) Type

FXFQ-LUV1



360° airflow improves temperature distribution and offers a comfortable living environment.



Ceiling Mounted Cassette (Compact Multi Flow) Type

FXZQ-MVE



Quiet, compact, and designed for user comfort



Ceiling Mounted Cassette (Double Flow) Type

FXCQ-MVE



Thin, lightweight, and easy to install in narrow ceiling spaces



Ceiling Mounted Cassette Corner Type

FXKQ-MAVE



Slim design for flexible installation



Slim Ceiling Mounted Duct Type (Standard Series)

FXDQ-PBVE(T)



FXDQ-NBVE(T)



Slim design, quietness and static pressure switching



Slim Ceiling Mounted Duct Type (Compact Series)

New FXDQ-SPV1



Slim and compact design for easy and flexible installation



Middle Static Pressure Ceiling Mounted Duct Type

New FXSQ-PVE



Middle external static pressure and slim design allow flexible installations



Ceiling Mounted Duct Type

FXMQ-PVE



FXMQ-MAVE



High external static pressure allows flexible installations



Outdoor-Air Processing Unit

FXMQ-MFV1



Combine fresh air treatment and air conditioning, supplied from a single system.



4-Way Flow Ceiling Suspended Type

FXUQ-AVEB



This slim and stylish indoor unit achieves optimum air distribution, and can be installed without the need for ceiling cavity



Ceiling Suspended Type

FXHQ-MAVE



Slim body with quiet and wide airflow



Wall Mounted Type

FXAQ-PVE



Stylish flat panel design harmonised with your interior décor



Floor Standing Type

FXLQ-MAVE



Concealed Floor Standing Type

FXNQ-MAVE



Suitable for perimeter zone air conditioning



Floor Standing Duct Type

New FXVQ-NY1



New FXVQ-NY16

(high static pressure type)

Large airflow type for large spaces. Flexible interior design for each tenant.



Air Handling Unit

AHUR



Integrate your air handling unit in a total solution for large size spaces such as factories and large stores.



Residential Indoor Units with connection to BP units

Slim Ceiling Mounted Duct Type

FDKS-EAVMB



FDKS-C(A)VMB



Slim and smooth design suits your shallow ceiling



Wall Mounted Type

New FTKJ-NVMW



New FTKJ-NVMS



Elegant appearance with European style



Wall Mounted Type

FTKS-DVM



FTKS-BVMA



FTKS-FVM



Stylish flat panel harmonises with your interior décor



VRV Indoor Units

Ceiling Mounted Cassette (Round Flow with Sensing) Type

FXFQ25S / FXFQ32S / FXFQ40S
FXFQ50S / FXFQ63S / FXFQ80S
FXFQ100S / FXFQ125S



Presence of people and floor temperature can be detected to provide comfort and energy savings

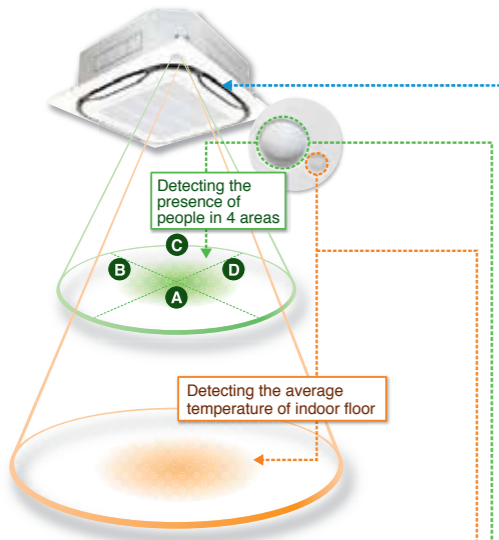

● Indoor unit offers 360° airflow discharges air in all directions with more uniform temperature distribution.



● Improved energy efficiency thanks to a new heat exchanger with smaller tubes, DC fan motor, and DC drain pump motor.

● Low operation sound level

● Drain pump is equipped as standard accessory with 850 mm lift.

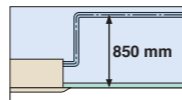

● Selectable airflow rate: 3 steps and Auto. (Auto airflow rate is available when BRC1E62 is used.)

● An antibacterial treatment that uses silver ions has been applied to the drain pan, preventing the growth of slime, mould and bacteria that cause blockages and odours. (The lifespan of a silver ion cartridge depends on the usage environment, but should be changed once every two to three years.)



Sensing function

Draft prevention function (default: OFF) *1. 2

Auto airflow direction mode

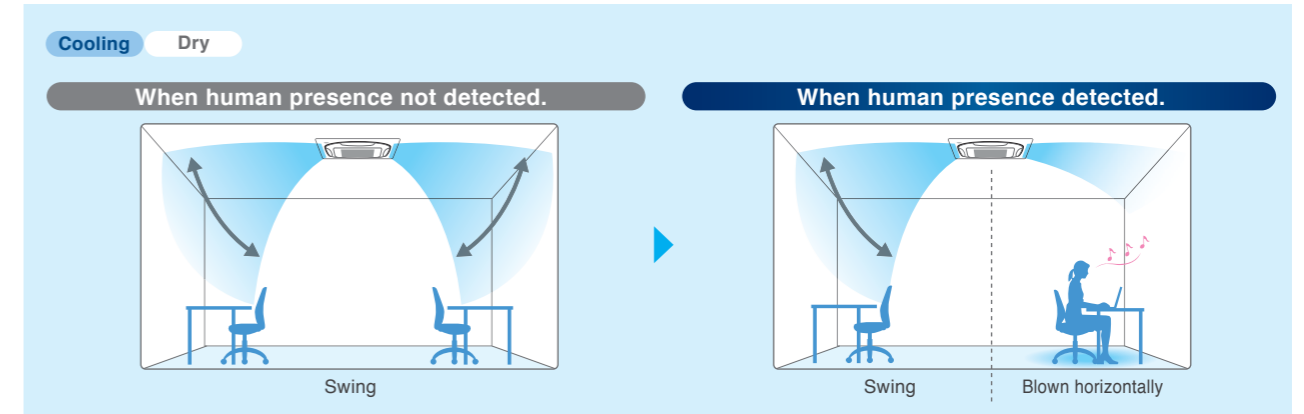

● With the Auto airflow direction mode, flaps are controlled to deliver optimal air distribution for both cooling and heating operations when there are no people.

● When a person is detected, drafts are prevented by making the flap horizontal.

● When a person is not detected for 5 minutes, the unit automatically returns to controlling the flaps for an unoccupied room.

*1. Airflow direction should be set to Auto. *2. Draft prevention function is OFF in the initial setting. It can be set ON using the remote controller.

Comfort and Energy saving preventing over Cooling *1. 2

Auto airflow direction mode + Auto airflow rate mode

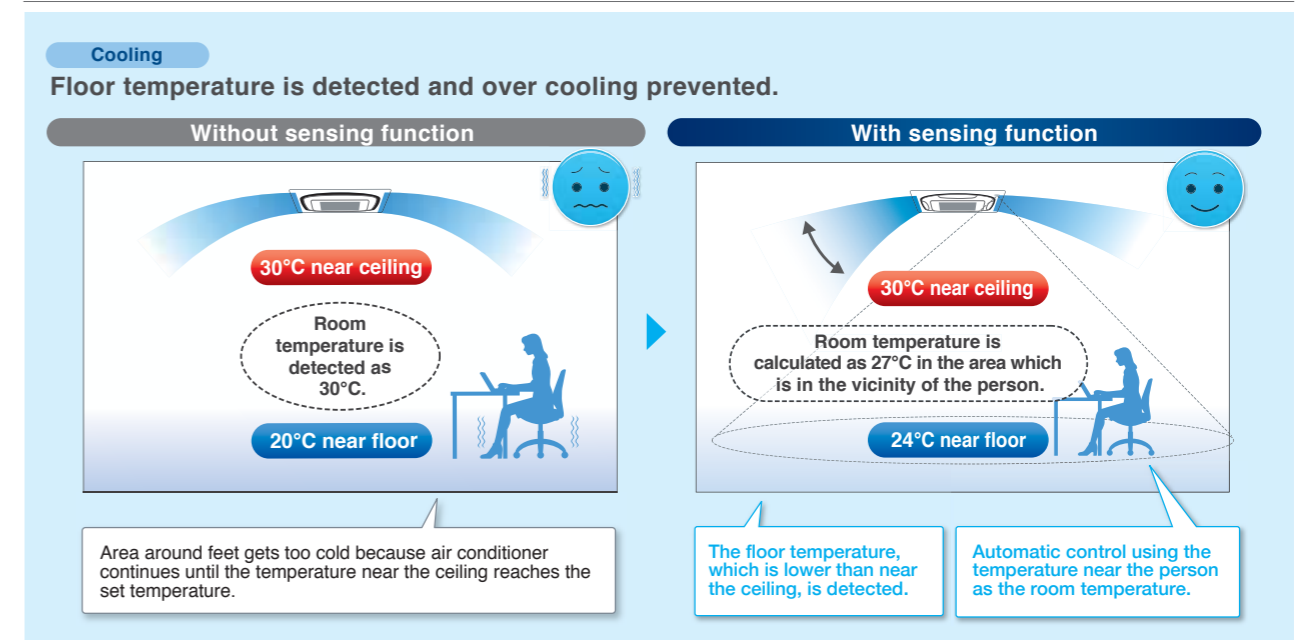

Energy savings The temperature near the person is automatically calculated by detecting the temperature of the floor. Energy is saved, because the area around the feet does not get too cold.

To increase comfort, Auto airflow rate mode controls the airflow in accordance with the difference between floor and ceiling temperatures.

When there is a large difference between the ceiling and floor temperatures, the airflow rate is automatically increased. When the difference becomes small, the airflow rate is automatically reduced.

*1. Both airflow direction and airflow rate should be set to Auto. *2. Draft prevention function is set OFF in the initial setting.

Individual airflow direction control

Thanks to the individual airflow direction control function, airflow direction can be individually adjusted for each air discharge outlet to prevent uncomfortable drafts and to deliver optimal air distribution.

Infrared presence sensor

The sensor detects human presence and adjusts the airflow direction automatically to prevent drafts.

Ceiling height	2.7m	3.5m	4.0m
Detection range (diameter)*1	approx. 8.5m	approx. 11.5m	approx. 13.5m

*1. The infrared presence sensor detects 80 cm above the floor.

Infrared floor sensor

The sensor detects the floor temperature and automatically adjusts operation of the indoor unit to reduce the temperature difference between the ceiling and the floor.

Ceiling height	2.7m	3.5m	4.0m
Detection range (diameter)*2	approx. 11m	approx. 14m	approx. 16m

*2. The infrared floor sensor detects at the floor surface.

VRV Indoor Units

Ceiling Mounted Cassette (Round Flow with Sensing) Type

Sensing sensor mode*1*2

Sensing sensor low mode (default: OFF)

When there are no people in a room, the set temperature is shifted automatically.

The system automatically saves energy by detecting whether or not the room is occupied. The set temperature is shifted automatically if the room is unoccupied.

Operation is reduced in places where there are no people.

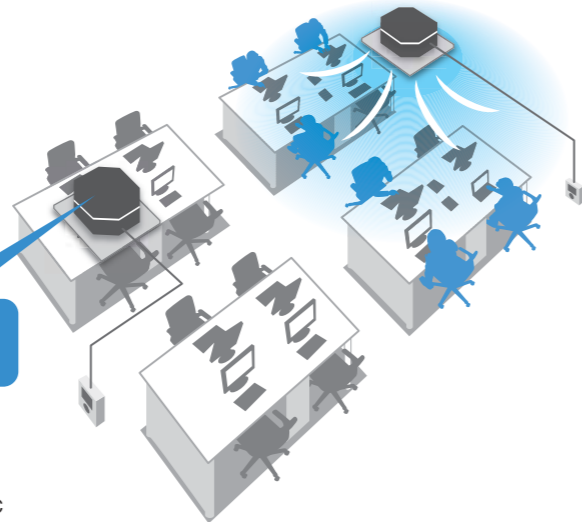

Example • Cooling setpoint: 26°C • Shift temperature: 1.0°C
• Shift time: 30 min. • Limit cooling temperature: 30°C

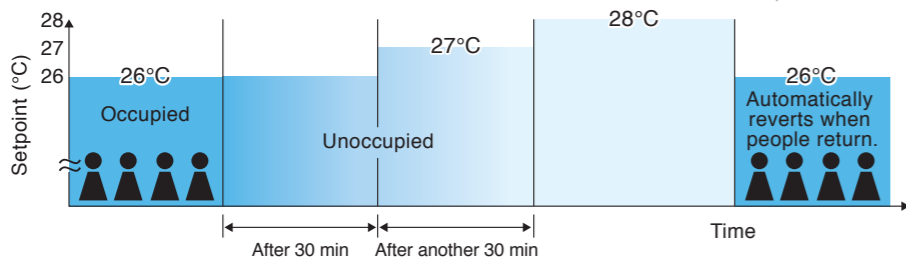

If people do not return, the air conditioner will raise the temperature 1°C every 30 minutes and then operate at 30°C.

Shift temperature and time can be selected from 0.5 to 4°C in 0.5°C increments and 15, 30, 45, 60, 90 or 120 minutes respectively with remote controller.

Sensing sensor stop mode (default: OFF)

When there are no people in a room, the system stops automatically.*3

The system automatically saves energy by detecting whether or not the room is occupied. Based on preset user conditions, the system automatically stops operation if the room is unoccupied.

Absent stop time can be selected from 1 to 24 hrs in 1 hr increments with remote controller.

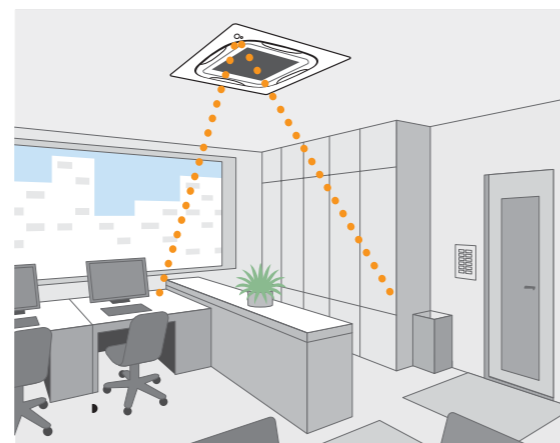

*1. These functions are not available when using the group control system.
*2. User can set these functions with remote controller.
*3. Please note that upon re-entering the room, air conditioner will not switch on automatically.

Individual airflow direction control

Individual airflow setting

Airflow direction of each of the four air outlets can be controlled individually. (Positions 0 to 4, Swing, Blocked, and No individual setting are selectable.)

Individual setting list		
Outletmark	Air direc.	Indiv.
<input type="checkbox"/>	blocked	ON
<input type="checkbox"/>	Auto	OFF
<input type="checkbox"/>	Position 2	ON
<input type="checkbox"/>	Swing	ON
Return		

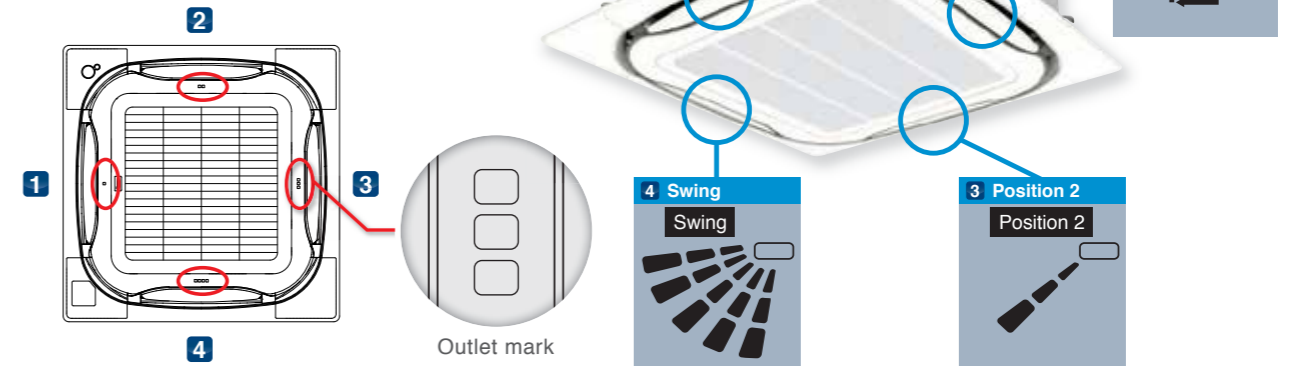

Airflow block function*1

Total comfort by individual airflow direction control and "airflow block function"

The system automatically saves energy by detecting whether or not the room is occupied. The set temperature is shifted automatically if the room is unoccupied.

- Airflow block function prevents uncomfortable drafts by reducing air velocity. It can be set using the BRC1E62 remote controller. There is no need for sealing material of air discharge outlet (option).
- This function only works when all-round flow is used. It cannot be used when sealing material is used in the air discharge outlet (option).

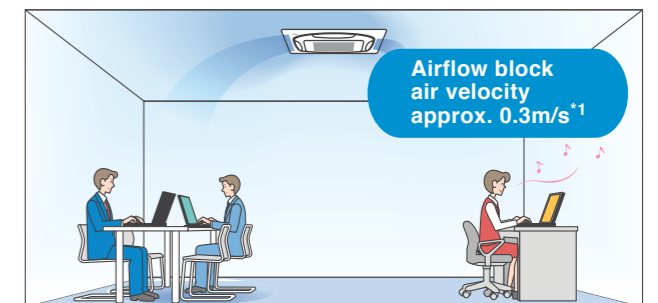

Airflow block function prevents uncomfortable drafts by reducing air velocity to approx. 0.3m/s.*2

Easy setup with remote controller

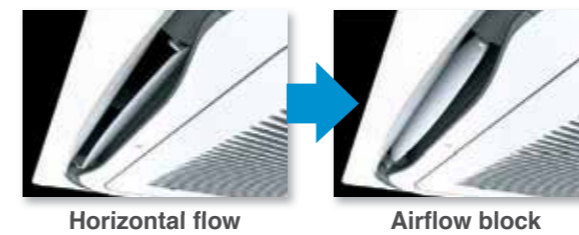

Horizontal flow

Airflow block

The airflow block function is useful when rearranging the room layout.

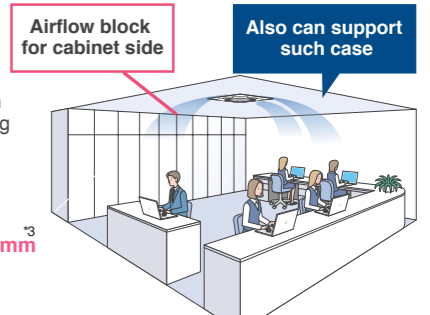
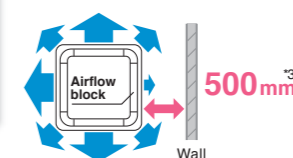

*1. Works in one direction only.
*2. In case of FXFQ63S type (Data is based on Daikin research.) When using FXFQ80S type or higher, if the airflow rate is set to High, airflow will be on the high side. Under actual conditions, however, the airflow value may differ depending on the effect of surrounding conditions and the way in which the temperature was adjusted.
*3. A gap of 1500 mm is required if the air block function is not used.

VRV Indoor Units

Ceiling Mounted Cassette (Round Flow) Type

FXFQ25LU / FXFQ32LU / FXFQ40LU
FXFQ50LU / FXFQ63LU / FXFQ80LU
FXFQ100LU / FXFQ125LU



360° airflow improves temperature distribution and offers a comfortable living environment

- The industry's first* Round Flow Ceiling Mounted Cassette type offers 360° airflow with improved temperature distribution.

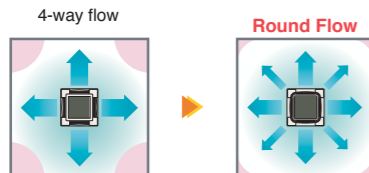

There are areas of uneven temperature.

There are much fewer areas of uneven temperature.

* As of April 2004, the release date for Japan.

- The light weight unit at 19.5 kg for FXFQ25-50LU models makes installation easy.

- Drain pump is equipped as a standard accessory with a 850 mm lift.

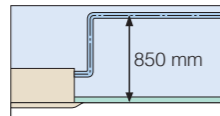

- A modern sophisticated decoration panel has been applied, with a panel surface that has been treated with a dirt-repellant coating.



- Control of the airflow rate can be selected from 3-step control.
- Low operation sound level
- The horizontal louvres prevent dew condensation. Their non-flocking surfaces, which repel dirt, are easy to clean.

Example of airflow patterns:

All-round flow is available, as well as 2-way to 4-way flows, so you can choose the most suitable airflow pattern depending on location or room layout.



Note: Whatever the discharge direction, the same type of panel is used. If installing for other than all-round flow, an air discharge outlet sealing material (option) must be used to close each unused outlet.



- An antibacterial treatment that uses silver ions has been applied to the drain pan, preventing the growth of slime, mould and bacteria that cause blockages and odours.

- An antibacterial treatment that uses silver ions has been applied to the drain pan, preventing the growth of slime, mould and bacteria that cause blockages and odours. (The lifespan of a silver ion cartridge depends on the usage environment, but should be changed once every two to three years.)



- The air filter has an anti-mould and antibacterial treatment that prevents the growth of mould generated from dust or moisture that may adhere to the filter.

Ceiling Mounted Cassette (Compact Multi Flow) Type

FXZQ20M / FXZQ25M / FXZQ32M
FXZQ40M / FXZQ50M



Quiet, compact, and designed for user comfort

- Dimensions correspond with 600 mm x 600 mm architectural module ceiling design specifications.

- Low operation sound level

	(230 V)(dB(A))			
FXZQ-M	20/25	32	40	50
Sound level (H/L)	30/25	32/26	36/28	41/33

- Comfortable airflow

1 Wide discharge angle: 0° to 60°

- Auto swing

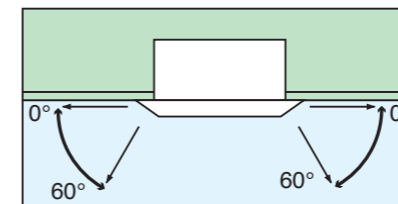

- Fixed angles: 5 levels

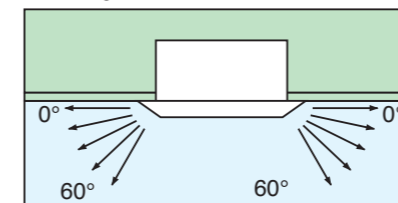

*Angles can be also set on site to prevent drafts (0°-35°) or soiling of the ceiling (25°-60°), other than standard setting (0°-60°).

2 2-, 3-, and 4-way airflow patterns are available, enabling installation in the corner of a room.

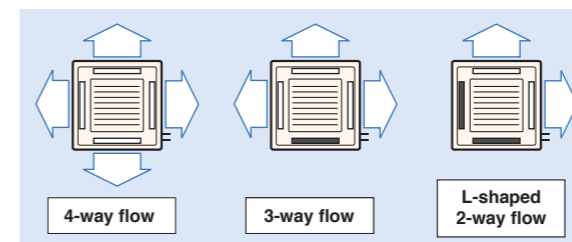

*For 3-way or 2-way flow installation, the sealing material for air discharge outlet (option) must be used to close each unused outlet.



- Drain pump is equipped as standard accessory with 750 mm lift.

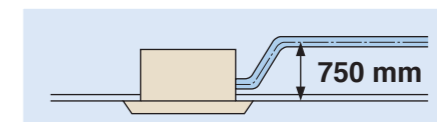

VRV Indoor Units

Ceiling Mounted Cassette (Round Flow) Type

FXFQ25LU / FXFQ32LU / FXFQ40LU
FXFQ50LU / FXFQ63LU / FXFQ80LU
FXFQ100LU / FXFQ125LU



360° airflow improves temperature distribution and offers a comfortable living environment

- The industry's first* Round Flow Ceiling Mounted Cassette type offers 360° airflow with improved temperature distribution.

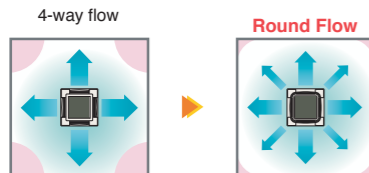

There are areas of uneven temperature.

There are much fewer areas of uneven temperature.

* As of April 2004, the release date for Japan.

- The light weight unit at 19.5 kg for FXFQ25-50LU models makes installation easy.

- Drain pump is equipped as a standard accessory with a 850 mm lift.

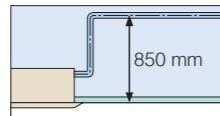

- A modern sophisticated decoration panel has been applied, with a panel surface that has been treated with a dirt-repellant coating.



- Control of the airflow rate can be selected from 3-step control.
- Low operation sound level
- The horizontal louvres prevent dew condensation. Their non-flocking surfaces, which repel dirt, are easy to clean.



- An antibacterial treatment that uses silver ions has been applied to the drain pan, preventing the growth of slime, mould and bacteria that cause blockages and odours.

- An antibacterial treatment that uses silver ions has been applied to the drain pan, preventing the growth of slime, mould and bacteria that cause blockages and odours. (The lifespan of a silver ion cartridge depends on the usage environment, but should be changed once every two to three years.)



- The air filter has an anti-mould and antibacterial treatment that prevents the growth of mould generated from dust or moisture that may adhere to the filter.

- Example of airflow patterns: All-round flow is available, as well as 2-way to 4-way flows, so you can choose the most suitable airflow pattern depending on location or room layout.



Note: Whatever the discharge direction, the same type of panel is used. If installing for other than all-round flow, an air discharge outlet sealing material (option) must be used to close each unused outlet.

Ceiling Mounted Cassette (Compact Multi Flow) Type

FXZQ20M / FXZQ25M / FXZQ32M
FXZQ40M / FXZQ50M



Quiet, compact, and designed for user comfort

- Dimensions correspond with 600 mm x 600 mm architectural module ceiling design specifications.

- Low operation sound level

	(230 V)(dB(A))			
FXZQ-M	20/25	32	40	50
Sound level (H/L)	30/25	32/26	36/28	41/33

- Comfortable airflow

- Wide discharge angle: 0° to 60°

- Auto swing

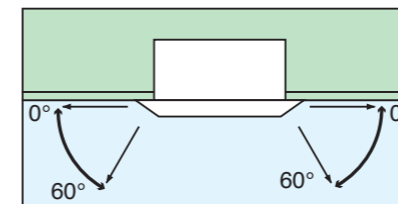

- Fixed angles: 5 levels

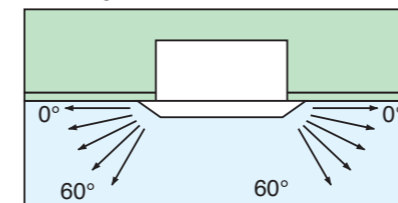

*Angles can be also set on site to prevent drafts (0°-35°) or soiling of the ceiling (25°-60°), other than standard setting (0°-60°).

- 2-, 3-, and 4-way airflow patterns are available, enabling installation in the corner of a room.

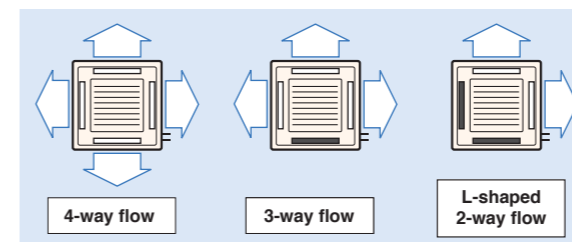

*For 3-way or 2-way flow installation, the sealing material for air discharge outlet (option) must be used to close each unused outlet.



- Drain pump is equipped as standard accessory with 750 mm lift.

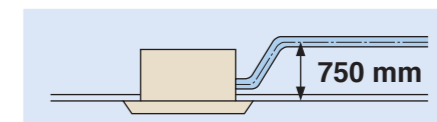

VRV Indoor Units

Slim Ceiling Mounted Duct Type (Standard Series)

Slim design, quietness and static pressure switching



Suited to use in drop-ceilings!

FXDQ20PB / FXDQ25PB / FXDQ32PB

- Only 700 mm in width and 23 kg in weight, this model is suitable to install in limited spaces like drop-ceilings in hotels.

Great for hotel use!

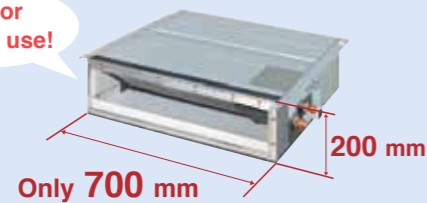

FXDQ40NB / FXDQ50NB / FXDQ63NB

- Only 200 mm in height, this model can be installed in rooms with as little as 240 mm in height for the ceiling space between the drop-ceiling and ceiling slab.

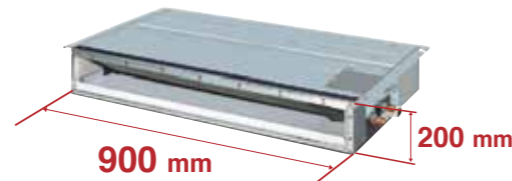

* 1,100 mm in width for the FXDQ63NB model.

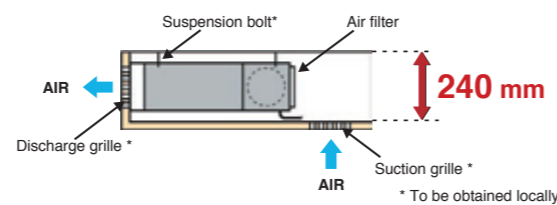

- External static pressure selectable by remote controller switching make this indoor unit a very comfortable and flexible model.

10 Pa-30 Pa/factory set: 10 Pa for FXDQ-PB models.
15 Pa-44 Pa/factory set: 15 Pa for FXDQ-NB models.

- FXDQ-PB and FXDQ-NB models are available in two types to suit different installation conditions.

FXDQ-PB/NBVE: with a drain pump (750 mm lift) as a standard accessory
FXDQ-PB/NBVET: without a drain pump

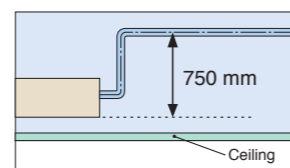

- Control of the airflow rate has been improved from 2-step to 3-step control.

- Low operation sound level

	(dB(A))				
FXDQ-PB/NB	20/25	32	40	50	63
Sound level (HH/HL)	28/26/23	28/26/24	30/28/26	33/30/27	33/31/29

* The values of operation sound level represent those for rear-suction operation. Sound level values for bottom-suction operation can be obtained by adding 5 dB(A).
* Values are based on the following conditions:
FXDQ-PB: external static pressure of 10 Pa; FXDQ-NB: external static pressure of 15 Pa.

Slim Ceiling Mounted Duct Type (Compact Series)

New

FXDQ20SP / FXDQ25SP
FXDQ32SP / FXDQ40SP
FXDQ50SP / FXDQ63SP



Slim and compact design for easy and flexible installation

- It comes with a slim and compact design with a height of only 200 mm that requires as little as 240 mm in height for the ceiling space between the drop-ceiling and ceiling slab. The depth of the product is only 450 mm which is suitable to install in limited spaces.

Great for residential use

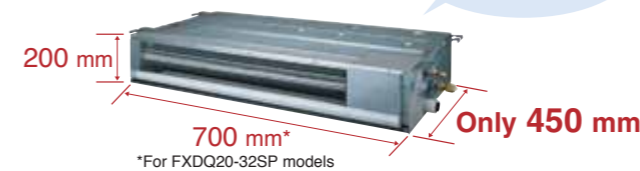

*For FXDQ20-32SP models



- It is available in two types – ceiling return and ordinary duct to suit different installation conditions.

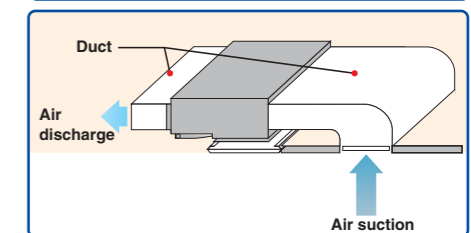
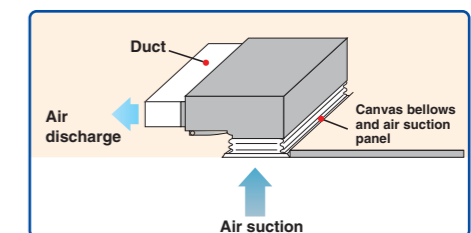

- Drain pump is equipped as standard accessory with 750 mm lift.

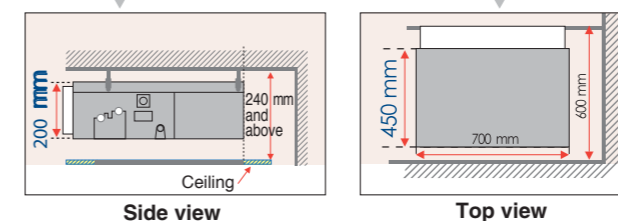
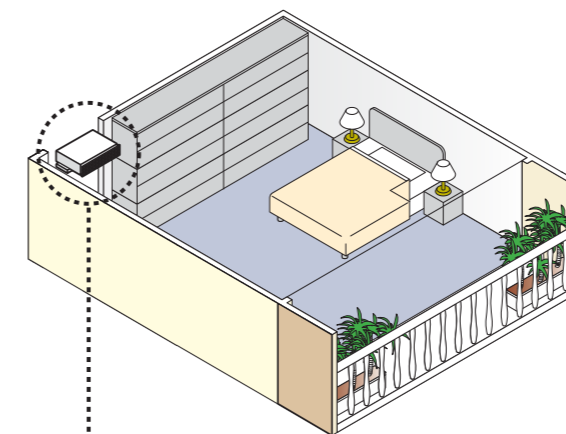
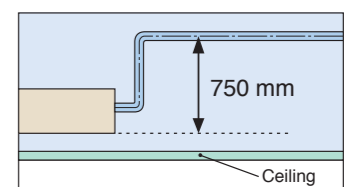

VRV Indoor Units

Middle Static Pressure Ceiling Mounted Duct Type

New
 FXSQ20P / FXSQ25P / FXSQ32P
 FXSQ40P / FXSQ50P / FXSQ63P
 FXSQ80P / FXSQ100P / FXSQ125P
 FXSQ140P



Middle external static pressure and slim design allow flexible installations

Installation flexibility

Slim design

- With a height of only 245 mm, installation is possible even in buildings with narrow ceiling spaces.

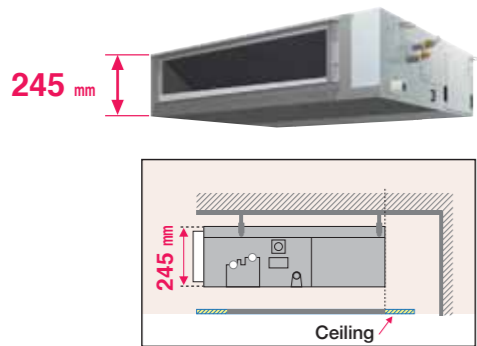

Standard DC drain pump

- DC drain pump is equipped as standard accessory with 850 mm lift.

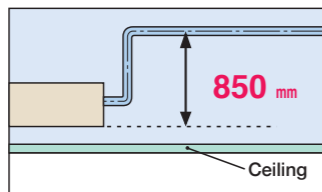

Bottom suction possible

- Bottom suction is possible which facilitates installation and maintenance. Wiring connections and maintenance of control box can be done from under the unit with an optional shield plate for side plate*, extending the degree of freedom for installation in the ceiling.

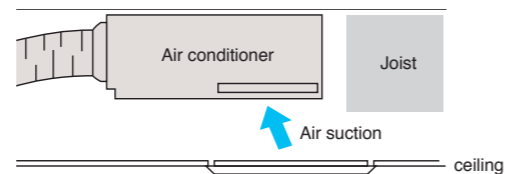

- Air suction direction can be altered from rear to bottom suction.

Rear suction

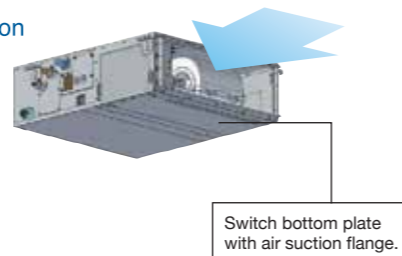

Bottom suction

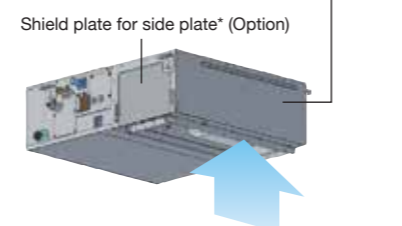

*An optional shield plate for side plate is required if wiring connections and maintenance of control box are needed from under the unit. This option is only available for FXSQ20-125P models.

Design flexibility

Adjustable external static pressure

- Using a DC fan motor, the external static pressure can be controlled within a range of 30 Pa* to 150 Pa.

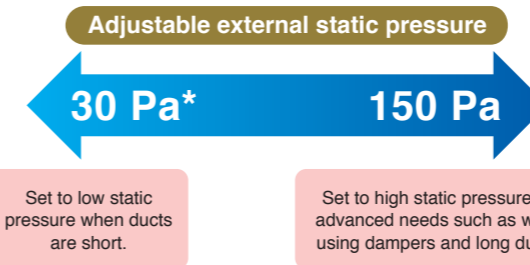

Comfortable airflow is achieved in accordance with conditions such as duct length.

*30 Pa-150 Pa for FXSQ20-40PVE
 50 Pa-150 Pa for FXSQ50-125PVE
 50 Pa-140 Pa for FXSQ140PVE

Comfort

Switchable airflow rate

- Control of the airflow rate can be selected from 3-step control.

Auto airflow rate

- 5-step airflow rate is automatically controlled in accordance with the difference between room temperature and set temperature. Auto airflow rate control can be selected with wired remote controller BRC1E62.

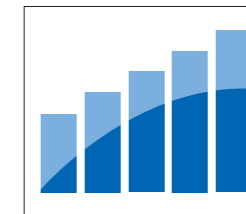

Low operation sound level

FXSQ-PVE	20/25	32	40	50	63
Sound level (H/M/L)	33/30/28	34/32/30	36/33/30	34/32/29	36/32/29
FXSQ-PVE	80	100	125	140	
Sound level (H/M/L)	37.5/34/30	39/35/32	42/38.5/35	43/40/36	



Easy installation

Airflow rate auto adjustment function

- During installation, even if the external static pressure changes due to a change in the duct route, the airflow can be automatically adjusted to within the unit's external static pressure range.
- Airflow rate can be controlled using a remote controller during test operation. It is automatically adjusted to the range between approximately ±10% of the rated H tap airflow.

Easy maintenance

- Inspection and cleaning is facilitated by separating the drain pipe and inspection opening and by the drain pan maintenance check hole.

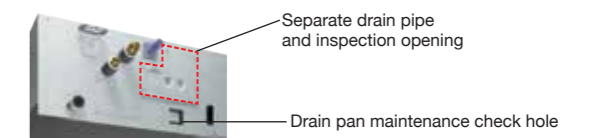

- The drain pan can be detached for easy cleaning. An antibacterial treatment that uses silver ions has been applied to the drain pan, preventing the growth of slime, mould and bacteria that cause blockages and odours.

- An antibacterial treatment that uses silver ions has been applied to the drain pan, preventing the growth of slime, mould and bacteria that cause blockages and odours. (The lifespan of a silver ion cartridge depends on the usage environment, but should be changed once every two to three years.)



VRV Indoor Units

Ceiling Mounted Duct Type

FXMQ20P / FXMQ25P / FXMQ32P
 FXMQ40P / FXMQ50P / FXMQ63P
 FXMQ80P / FXMQ100P / FXMQ125P
 FXMQ140P

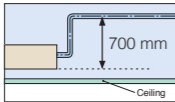

Middle and high static pressure allows for flexible duct design

- A DC fan motor increases the external static pressure capacity range to include middle to high static pressures, increasing design flexibility.
 30 Pa–100 Pa for FXMQ20P–32P
 30 Pa–160 Pa for FXMQ40P
 50 Pa–200 Pa for FXMQ50P–125P
 50 Pa–140 Pa for FXMQ140P
- All models are only 300 mm in height, an improvement over the 390 mm height of conventional models. The weight of the FXMQ40P has been reduced from 44 kg to 28 kg.
- Drain pump is equipped as standard accessory with 700 mm lift. 
- Control of the airflow rate has been improved from 2-step to 3-step control.
- Low operation sound level
- Energy-efficient
 - The adopted DC fan motor is much more efficient than the conventional AC motor, yielding an approximate 20% decrease in energy consumption (FXMQ125P).
- Improved ease of installation
 - Airflow rate can be controlled using a remote controller during test operation. With the conventional model, the airflow rate was controlled from the PC board. It is automatically adjusted to the range between approximately $\pm 10\%$ of the rated HH tap airflow for FXMQ20P–125P.



- Improved ease of maintenance
 - The drain pan can be detached for easy cleaning. An antibacterial treatment that uses silver ions has been applied to the drain pan, preventing the growth of slime, mould and bacteria that cause blockages and odours.
- An antibacterial treatment that uses silver ions has been applied to the drain pan, preventing the growth of slime, mould and bacteria that cause blockages and odours. (The lifespan of a silver ion cartridge depends on the usage environment, but should be changed once every two to three years.) 

FXMQ200MA/FXMQ250MA



- Simplified Static Pressure Control
 External static pressure can be easily adjusted using a change-over switch inside the electrical box to meet the resistance in the duct system.

- Built-in Drain Pump (Option)
 Housing the drain pump inside the unit reduces the space required for installation.

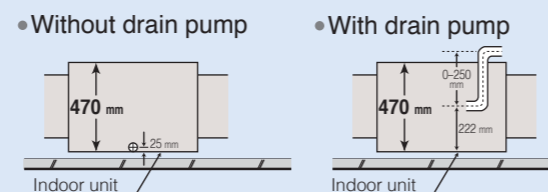



4-Way Flow Ceiling Suspended Type

FXUQ71A / FXUQ100A

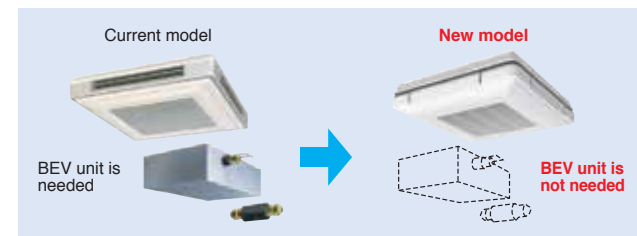

This slim and stylish indoor unit achieves optimum air distribution, and can be installed without the need for ceiling cavity

- Unit body and suction panel adopted round shapes and realised a slim appearance design. The unit can be used for various locations such as the ceilings with no cavity and bare ceilings.
- Flaps close automatically when the unit stops, which gives a simple appearance. 
- Unified slim height of 198 mm for all models that gives the unified impression even when models with different capacities are installed in the same area. 
- Built-in electronic expansion valve eliminates the need for a BEV unit, which improves flexibility of installation. 



- Control of the airflow rate has been improved from 2-step to 3-step control. Auto airflow rate control can be selected with wired remote controller BRC1E62.
- Energy efficiency has been improved thanks to the adoption of a new heat exchanger with smaller tubes, DC fan motor and DC drain pump motor.
- Drain pump is equipped as a standard accessory, and the lift height has been improved from 500 mm to 600 mm.
- Depending on installation site requirements or room conditions, 2-way, 3-way and 4-way discharge patterns are available.

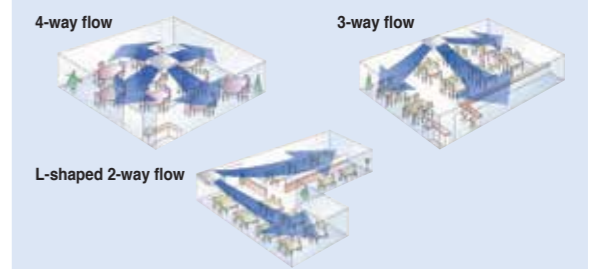

- With adoption of the individual flap control, airflow direction adjustment can be individually set for each outlet. 5 directions of airflow and auto-swing can be selected with wired remote controller BRC1E62, which realises the optimum air distribution.

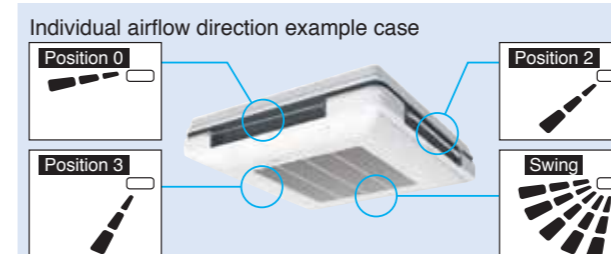

- An antibacterial treatment that uses silver ions has been applied to the drain pan, preventing the growth of slime, mould and bacteria that cause blockages and odours. (The lifespan of a silver ion cartridge depends on the usage environment, but should be changed once every two to three years.) 

VRV Indoor Units

Ceiling Suspended Type

FXHQ32MA / FXHQ63MA
FXHQ100MA



Slim body with quiet and wide airflow

●Adoption of QUIET STREAM FAN

Uses the quiet stream fan and many more advanced technologies.

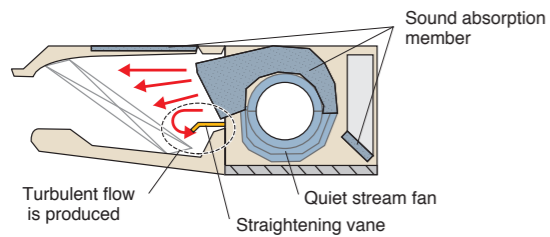

●Low operation sound level

FXHQ-MA	32	63	100
Sound level (H/L)	36/31	39/34	45/37

●Installation is easy

- Drain pump kit (option) can be easily incorporated.

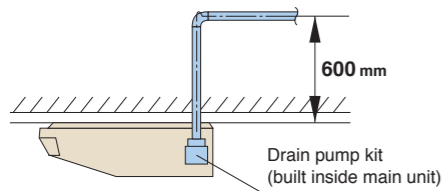

●Wide air discharge openings produce a spreading 100° airflow.

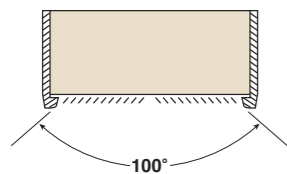

●Maintenance is easy

- Non-dew Flap with no implanted bristles

Bristle-free Flap minimises contamination and makes cleaning simpler.



- Easy-to-clean flat design

●Maintenance is easier because everything can be performed from below the unit.

- A long-life filter (maintenance free up to one year*) is equipped as standard accessory.

* 8 hr/day, 25 day/month. For dust concentration of 0.15 mg/m³

Wall Mounted Type

FXAQ20P / FXAQ25P
FXAQ32P / FXAQ40P
FXAQ50P / FXAQ63P



Stylish flat panel design harmonised with your interior décor

- Stylish flat panel design creates a graceful harmony that enhances any interior space.

- Flat panel can be cleaned with only the single pass of a cloth across their smooth surface. Flat panel can also be easily removed and washed for more thorough cleaning.

●Low operation sound level

FXAQ-P	20	25	32	40	50	63
Sound level (H/L)	35/31	36/31	38/31	39/34	42/37	47/41

- Drain pan and air filter can be kept clean by mould-proof polystyrene.

- Vertical auto-swing realises efficiency of air distribution. The louvre closes automatically when the unit stops.

- 5 steps of discharge angle can be set by remote controller.

- Discharge angle is automatically set at the same angle as the previous operation when restarting. (Initial setting: 10° for cooling and 70° for heating)

- Flexible installation

- Drain pipe can be fitted to from either left or right sides.



- Drain pump kit is available as optional accessory, which lifts the drain 1,000 mm from the bottom of the unit.

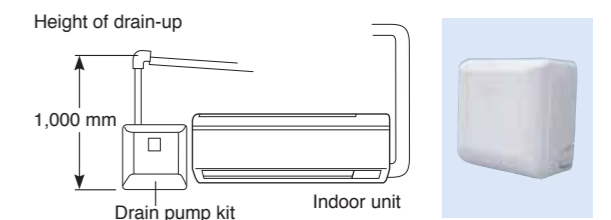

VRV Indoor Units

Floor Standing Type

FXLQ20MA / FXLQ25MA
FXLQ32MA / FXLQ40MA
FXLQ50MA / FXLQ63MA



Suitable for perimeter zone air conditioning

- Floor Standing types can be hung on the wall for easier cleaning. Running the piping from the back allows the unit to be hung on walls. Cleaning under the unit, where dust tends to accumulate, is considerably easier.
- The adoption of a fibre-less discharge grille featuring an original design to prevent condensation also helps prevent staining and makes cleaning easier.
- A long-life filter (maintenance free up to one year*) is equipped as standard accessory.

* 8 hr/day, 25 day/month. For dust concentration of 0.15 mg/m³

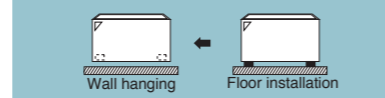

Concealed Floor Standing Type

FXNQ20MA / FXNQ25MA
FXNQ32MA / FXNQ40MA
FXNQ50MA / FXNQ63MA



Designed to be concealed in the perimeter skirting-wall

- The unit is concealed in skirting-wall of perimeter, that enables to create high class interior design.
- The connecting port faces downward, greatly facilitating on-site piping work.
- A long-life filter (maintenance free up to one year*) is equipped as standard accessory.

* 8 hr/day, 25 day/month. For dust concentration of 0.15 mg/m³

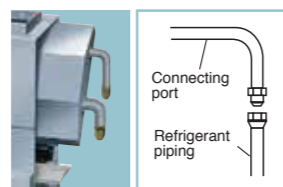

* Applies also to Floor Standing type (FXLQ-MA).



Floor Standing Duct Type

New

FXVQ125N / FXVQ200N
FXVQ250N / FXVQ400N
FXVQ500N



Large airflow type for large spaces. Flexible interior design for each tenant

- Large airflow type that fits for spacious areas such as factories and large stores.
- Various installations can be supported from full-scale duct connection airflow to direct airflow that allows for easy installation.
- Full-scale duct connection airflow allows for air conditioning evenly in spacious areas.

Duct connection airflow type

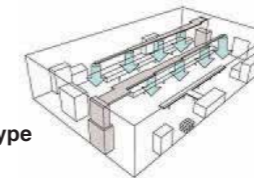

- Adding the plenum chamber (option) allows for simple operation with direct airflow.

* Note that the operation sound increases by approximately 5 dB(A).

Direct airflow type

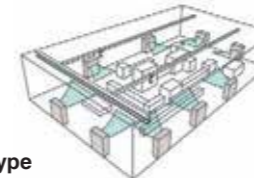

- The high static pressure type driven by the belt drive system allows for use of air discharge outlets in various shapes as well as long ducts. Highly flexible installation is possible.
- Design with high maintainability that allows major services and maintenance services to be performed at the front.
- A long-life filter (maintenance free up to one year*) is equipped as a standard accessory.
- A wide range of optional accessories are available such as high-efficiency filters.

- Outdoor air intake mode is useable as an outdoor-air processing air conditioner.

*When using the unit as an outdoor-air processing unit, there are some restrictions. Strictly follow the restrictions specified in the Engineering Data Book.

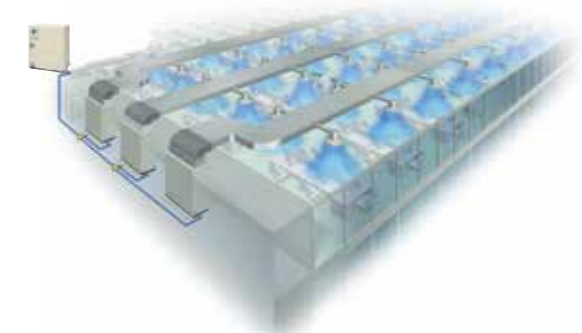
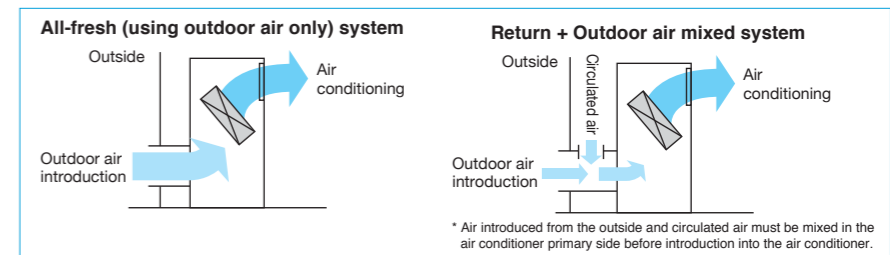

Residential Indoor Units with connection to BP units

Slim Ceiling Mounted Duct Type



<700 mm width type>
FDKS25EA / FDKS35EA
 <900/1,000 mm width type>
FDKS25CA / FDKS35CA
FDKS50C / FDKS60C



Standard accessory
 Note: Remote controllers other than the standard accessory wireless remote controller cannot be used.

Slim and smooth design suits your shallow ceiling

- Models in the FDKS-EA series are only 700 mm in width and 21 kg in weight, so are easily installed in limited spaces. Just 200 mm in height, all models can be installed in rooms with as little as 240 mm depth between the drop ceiling and ceiling slab, making them ideal for even shallow ceilings.

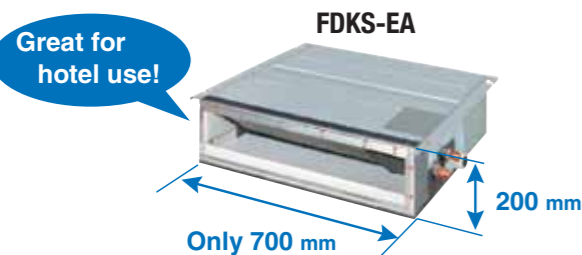

	FDKS25EA	FDKS35EA	FDKS25CA	FDKS35CA
Dimensions (H x W x D)	200 x 700 x 620 mm	200 x 900 x 620 mm		
Weight	21 kg		25 kg	
Airflow rate (H)	8.7 m³/min		9.5 m³/min	10 m³/min
External static pressure	30 Pa		40 Pa	

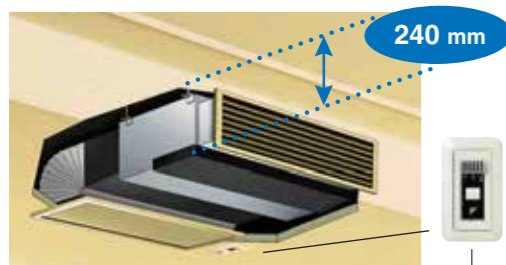

Signals from the wireless remote controller are transmitted to the signal receiver.

- Low operation sound level (H/L/SL)

FDKS25	FDKS35	FDKS50	FDKS60
35/31/29 dB (A)	35/31/29 dB (A)	37/33/31 dB (A)	38/34/32 dB (A)

- Home Leave Operation prevents large rises or falls in the indoor temperature by continuing operation* while you are sleeping or out of your home. This means that an air-conditioned welcome awaits when you wake or return. It also means that the indoor temperature can quickly return to your favourite comfort setting.

* Home Leave Operation can be selected for any temperature from 18 to 32°C for cooling operation and 10 to 30°C for heating operation.
 * Home Leave Operation function must be set using the remote controller when going to sleep or leaving the house, and after waking up or returning home.

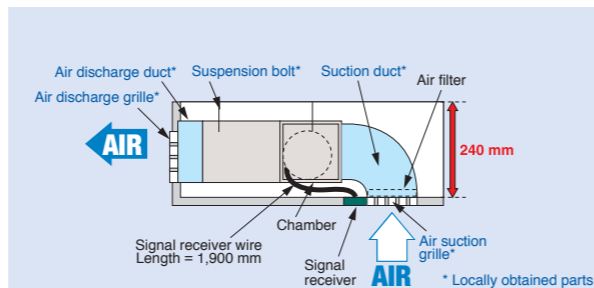

- Notes:
1. To prevent an increase in operation noise, avoid installing the air suction grille directly below the suction chamber.
 2. Grilles, piping connections, ducts, and installation parts should be obtained locally. Slim Ceiling Mounted Duct type models do not have drain-up pumps.
 3. The signal receiver unit must be located near the air suction inlet, because the unit includes a sensor that detects room temperature.

Wall Mounted Type

New **FTKJ25N / FTKJ35N / FTKJ50N**



Note: Remote controllers other than the standard accessory wireless remote controller cannot be used.

Elegant appearance with European style

Elegant Appearance with Curved Panel

- The sleek design of the FTKJ-N indoor unit features a uniquely European style. This elegant body houses state-of-the-art technology which delivers superior performance. The FTKJ-N series offers a versatile choice for home-owners, designers and architects alike.



Comfort Airflow Mode

- Comfort Airflow Mode prevents uncomfortable drafts from blowing directly on to a person's body. During cooling operation, the flap moves upwards to prevent cold drafts. During heating operation, the flap turns vertically downwards to drive warm air to the floor.

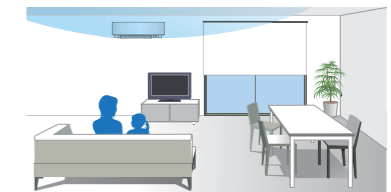

3D Airflow

- 3D Airflow combines Vertical and Horizontal Auto-Swing to reduce indoor temperature fluctuation. This function circulates air to every part of a room for uniform cooling or heating of even large spaces. To start 3D Airflow, push both the Vertical and Horizontal Auto-Swing buttons. The flaps and louvers swing in turn.

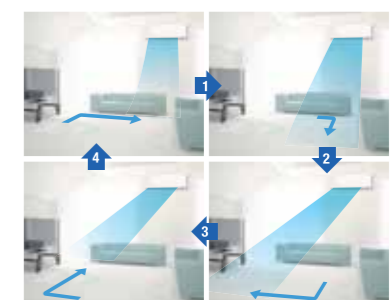

The flaps and louvers swing in turn, expanding the comfort zone.

Two-Area Intelligent Eye

- A combination of Comfort Airflow Mode and Intelligent Eye directs airflow away from people to avoid drafts. If there is no movement in a room for 20 minutes, Intelligent Eye automatically adjusts the set temperature by approximately 2°C to save energy.

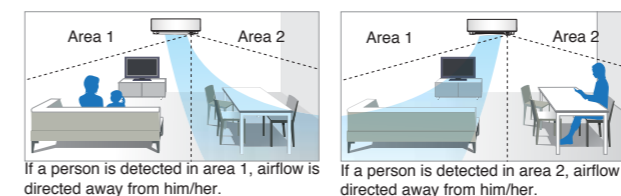

If a person is detected in area 1, airflow is directed away from him/her.

If a person is detected in area 2, airflow is directed away from him/her.

Residential Indoor Units with connection to BP units

Wall Mounted Type



* Remote controllers other than the standard accessory wireless remote controller cannot be used.

Stylish flat panel harmonises with your interior d'Écor

- Wall Mounted indoor units achieve quiet sound levels of 22 dB (A). (H/L/SL)

FTKS25D	FTKS35D	FTKS50F	FTKS60F	FTKS71F
37/25/22 dB (A)	39/26/23 dB (A)	43/34/31 dB (A)	45/36/33 dB (A)	46/37/34 dB (A)

- Intelligent Eye with its infrared sensor automatically controls air conditioner operation according to human movement in a room. When there is no movement, it adjusts the temperature by 2°C for energy savings.



When you are in the room

When you go out

- 3-D Airflow combines Vertical and Horizontal Auto-Swing to circulate air to every part of a room for uniform cooling of even large spaces.

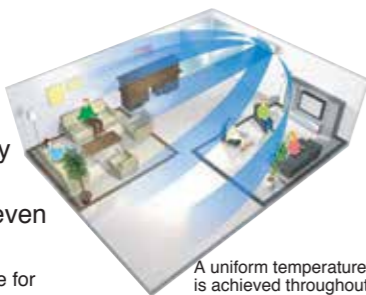

* This function is available for FTKS50/60/71F.

A uniform temperature is achieved throughout the entire room.

- Titanium apatite is a photocatalytic material with high adsorption power. Titanium apatite also effectively adsorbs and decomposes bacteria across its entire surface. The photocatalyst is activated simply by exposure to light.

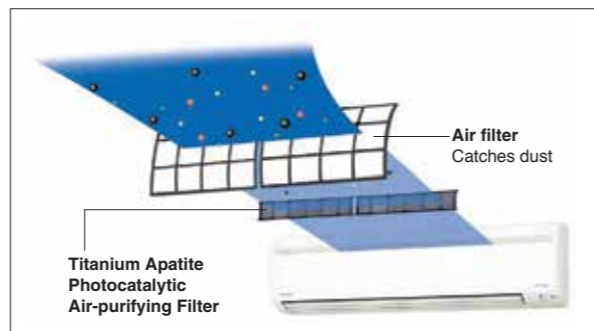

These filters are not medical devices. Benefits such as the adsorption and decomposition of bacteria are only effective for substances that are collected on and in direct contact with the Titanium Apatite Photocatalytic Air-Purifying Filter.

Bacteria Removal Test
 Testing method: dropping method
 Result certificate: No. 012553-1 and 012553-2
 Testing organisation: Japan Spinners Inspecting Foundation



VRV Indoor Units

Ceiling Mounted Cassette (Round Flow with Sensing) Type



MODEL		FXFQ25SVM	FXFQ32SVM	FXFQ40SVM	FXFQ50SVM
Power supply		1-phase, 220-240 V/220-230 V, 50/60 Hz			
Cooling capacity	kcal/h	2,400	3,100	3,900	4,800
	Btu/h	9,600	12,300	15,400	19,100
	kW	2.8	3.6	4.5	5.6
Power consumption	Cooling kW	0.031	0.031	0.041	0.080
Casing		Galvanised steel plate			
Airflow rate (H/M/L)	m ³ /min	12.5/11.5/10.0	12.5/11.5/10.0	14.5/13.0/11.0	22.0/17.5/13.5
	cfm	441/406/353	441/406/353	512/459/388	777/618/477
Sound level (H/M/L)	dB(A)	30/28.5/27	30/28.5/27	31/29/27	36/32/28
Dimensions (HxWxD)	mm	246x840x840			
Machine weight	kg	19		23	
Piping connections	Liquid (Flare)	φ6.4			
	Gas (Flare)	φ12.7			
	Drain	VP25 (External Dia, 32/Internal Dia, 25)			
Panel (Option)	Model	BYCQ125B-W1			
	Colour	Fresh white			
	Dimensions(HxWxD)	mm 50x950x950			
	Weight	kg 5.5			

MODEL		FXFQ63SVM	FXFQ80SVM	FXFQ100SVM	FXFQ125SVM
Power supply		1-phase, 220-240 V/220-230 V, 50/60 Hz			
Cooling capacity	kcal/h	6,100	7,700	9,600	12,000
	Btu/h	24,200	30,700	38,200	47,800
	kW	7.1	9.0	11.2	14.0
Power consumption	Cooling kW	0.095	0.095	0.194	0.219
Casing		Galvanised steel plate			
Airflow rate (H/M/L)	m ³ /min	23.5/18.5/13.5	23.5/19.5/15.0	33.0/26.0/19.0	34.5/27.5/21.0
	cfm	830/653/477	830/688/530	1,165/918/671	1,218/971/741
Sound level (H/M/L)	dB(A)	38/33/28	38/35/31	44/38/32	45/40/35
Dimensions (HxWxD)	mm	246x840x840		288x840x840	
Machine weight	kg	23		26	
Piping connections	Liquid (Flare)	φ9.5			
	Gas (Flare)	φ15.9			
	Drain	VP25 (External Dia, 32/Internal Dia, 25)			
Panel (Option)	Model	BYCQ125B-W1			
	Colour	Fresh white			
	Dimensions(HxWxD)	mm 50x950x950			
	Weight	kg 5.5			

Note: Specifications are based on the following conditions:
 •Cooling: Indoor temp.: 27°CDB, 19°CWB/inlet water temp.: 30°C, Equivalent piping length: 7.5 m, Level difference: 0 m.
 •Capacity of indoor unit is only for reference. Actual capacity of indoor unit is based on the total capacity index.
 (See Engineering Data Book for details.)
 •Sound level: Anechoic chamber conversion value, measured at a point 1.5 m downward from the unit centre.
 During actual operation, these values are normally somewhat higher as a result of ambient conditions.

VRV Indoor Units

Ceiling Mounted Cassette (Round Flow) Type



MODEL		FXFQ25LUV1	FXFQ32LUV1	FXFQ40LUV1	FXFQ50LUV1	FXFQ63LUV1	FXFQ80LUV1	FXFQ100LUV1	FXFQ125LUV1	
Power supply		1-phase, 220-240 V, 50 Hz								
Cooling capacity	kcal/h	2,400	3,100	3,900	4,800	6,100	7,700	9,600	12,000	
	Btu/h	9,600	12,300	15,400	19,100	24,200	30,700	38,200	47,800	
	kW	2.8	3.6	4.5	5.6	7.1	9.0	11.2	14.0	
Power consumption	Cooling	kW	0.033	0.033	0.047	0.052	0.066	0.093	0.187	0.209
Casing		Galvanised steel plate								
Airflow rate (HH/H/L)	m ³ /min	13/11.5/10	13/11.5/10	15/13/11	16/13.5/11	19/16.5/13.5	21/18/15	32/26/20	33/28/22.5	
	cfm	459/406/353	459/406/353	530/459/388	565/477/388	671/583/477	742/636/530	1,130/918/706	1,165/989/794	
Sound level (HH/H/L)	dB(A)	30/28.5/27	30/28.5/27	31/29/27	32/29.5/27	34/31/28	36/33.5/31	43/37.5/32	44/39/34	
Dimensions (HxWxD)	mm	246x840x840						288x840x840		
Machine weight	kg	19.5			22		25			
Piping connections	Liquid (Flare)	φ 6.4			φ 9.5					
	Gas (Flare)	φ 12.7			φ 15.9					
	Drain	VP25 (External Dia, 32/Internal Dia, 25)								
Panel (Option)	Model	BYCP125K-W1								
	Colour	Fresh white								
	Dimensions(HxWxD)	50x950x950								
	Weight	5.5								

Ceiling Mounted Cassette (Compact Multi Flow) Type



MODEL		FXZQ20MVE	FXZQ25MVE	FXZQ32MVE	FXZQ40MVE	FXZQ50MVE
Power supply		1-phase, 220-240 V/220 V, 50/60 Hz				
Cooling capacity	kcal/h	1,900	2,400	3,100	3,900	4,800
	Btu/h	7,500	9,600	12,300	15,400	19,100
	kW	2.2	2.8	3.6	4.5	5.6
Power consumption	Cooling	kW	0.073	0.076	0.089	0.115
Casing		Galvanised steel plate				
Airflow rate (H/L)	m ³ /min	9/7	9.5/7.5	11/8	14/10	
	cfm	318/247	335/265	388/282	493/353	
Sound level (H/L)	230 V, 50 Hz 240 V, 50 Hz	dB(A)	30/25-32/26	32/26-34/28	36/28-37/29	41/33-42/35
Dimensions (HxWxD)	mm	286x575x575				
Machine weight	kg	18				
Piping connections	Liquid (Flare)	φ 6.4				
	Gas (Flare)	φ 12.7				
	Drain	VP20 (External Dia, 26/Internal Dia, 20)				
Panel (Option)	Model	BYFQ60B3W1				
	Colour	White (6.5Y9.5/0.5)				
	Dimensions(HxWxD)	55x700x700				
	Weight	2.7				

Note: Specifications are based on the following conditions:
 •Cooling: Indoor temp.: 27°CDB, 19°CWB/inlet water temp.: 30°C, Equivalent piping length: 7.5 m, Level difference: 0 m.
 •Capacity of indoor unit is only for reference. Actual capacity of indoor unit is based on the total capacity index.
 (See Engineering Data Book for details.)
 •Sound level: Anechoic chamber conversion value, measured at a point 1.5 m downward from the unit centre.
 During actual operation, these values are normally somewhat higher as a result of ambient conditions.

Ceiling Mounted Cassette (Double Flow) Type



MODEL		FXCQ20MVE	FXCQ25MVE	FXCQ32MVE	FXCQ40MVE	FXCQ50MVE	FXCQ63MVE	FXCQ80MVE	FXCQ125MVE	
Power supply		1-phase, 220-240 V/220 V, 50/60 Hz								
Cooling capacity	kcal/h	1,900	2,400	3,100	3,900	4,800	6,100	7,700	12,000	
	Btu/h	7,500	9,600	12,300	15,400	19,100	24,200	30,700	47,800	
	kW	2.2	2.8	3.6	4.5	5.6	7.1	9.0	14.0	
Power consumption	Cooling	kW	0.077	0.092	0.092	0.130	0.130	0.161	0.209	0.256
Casing		Galvanised steel plate								
Airflow rate (HH/M/L)	m ³ /min	7/5	9/6.5	9/6.5	12/9	12/9	16.5/13	26/21	33/25	
	cfm	247/177	318/230	318/230	424/318	424/318	582/459	918/741	1,165/883	
Sound level (H/L)	220 V	dB(A)	32/27	34/28	34/28	34/29	34/29	37/32	39/34	44/38
	240 V	dB(A)	34/29	36/30	36/30	37/32	37/32	39/34	41/36	46/40
Dimensions (HxWxD)	mm	305x775x600	305x775x600	305x775x600	305x990x600	305x990x600	305x1,175x600	305x1,665x600	305x1,665x600	
Machine weight	kg	26.0	26.0	26.0	31.0	32.0	35.0	47.0	48.0	
Piping connections	Liquid (Flare)	φ 6.4		φ 6.4		φ 6.4		φ 9.5		
	Gas (Flare)	φ 12.7		φ 12.7		φ 12.7		φ 15.9		
	Drain	VP25 (External Dia, 32/Internal Dia, 25)								
Panel (Option)	Model	BYBC32G-W1		BYBC50G-W1		BYBC63G-W1		BYBC125G-W1		
	Colour	White (10Y9/0.5)								
	Dimensions(HxWxD)	mm	53x1,030x680	53x1,030x680	53x1,030x680	53x1,245x680	53x1,245x680	53x1,430x680	53x1,920x680	53x1,920x680
	Weight	kg	8.0	8.0	8.0	8.5	8.5	9.5	12.0	12.0

Ceiling Mounted Cassette Corner Type



MODEL		FXKQ25MAVE	FXKQ32MAVE	FXKQ40MAVE	FXKQ63MAVE	
Power supply		1-phase, 220 - 240 V/220 V, 50/60 Hz				
Cooling capacity	kcal/h	2,400	3,100	3,900	6,100	
	Btu/h	9,600	12,300	15,400	24,200	
	kW	2.8	3.6	4.5	7.1	
Power consumption	Cooling	kW	0.066	0.066	0.076	0.105
Casing		Galvanised steel plate				
Airflow rate (H/L)	m ³ /min	11/9	11/9	13/10	18/15	
	cfm	388/318	388/318	459/353	635/530	
Sound level (H/L)	220 V	dB(A)	38/33	38/33	40/34	42/37
	240 V	dB(A)	40/35	40/35	42/36	44/39
Dimensions (HxWxD)	mm	215x1,110x710	215x1,110x710	215x1,110x710	215x1,310x710	
Machine weight	kg	31	31	31	34	
Piping connections	Liquid (Flare)	φ 6.4		φ 6.4		
	Gas (Flare)	φ 12.7		φ 12.7		
	Drain	VP25 (External Dia, 32/Internal Dia, 25)				
Panel (Option)	Model	BYK45FJW1		BYK71FJW1		
	Colour	White (10Y9/0.5)				
	Dimensions(HxWxD)	mm	70x1,240x800	70x1,240x800	70x1,240x800	70x1,440x800
	Weight	kg	8.5	8.5	8.5	9.5

Note: Specifications are based on the following conditions:
 •Cooling: Indoor temp.: 27°CDB, 19°CWB/inlet water temp.: 30°C, Equivalent piping length: 7.5 m, Level difference: 0 m.
 •Capacity of indoor unit is only for reference. Actual capacity of indoor unit is based on the total capacity index.
 (See Engineering Data Book for details.)
 •Sound level: (FXKQ-M) Anechoic chamber conversion value, measured at a point 1.5 m downward from the unit centre.
 (FXKQ-MA) Anechoic chamber conversion value, measured at a point 1 m in front of the unit and 1 m downward.
 During actual operation, these values are normally somewhat higher as a result of ambient conditions.

VRV Indoor Units

Slim Ceiling Mounted Duct Type (Standard Series)



700 mm width type

MODEL	with drain pump		FXDQ20PBVE	FXDQ25PBVE	FXDQ32PBVE
	without drain pump		FXDQ20PBVET	FXDQ25PBVET	FXDQ32PBVET
Power supply	1-phase, 220-240 V/220 V, 50/60 Hz				
Cooling capacity		kcal/h	1,900	2,400	3,100
		Btu/h	7,500	9,600	12,300
		kW	2.2	2.8	3.6
Power consumption (FXDQ-PBVE)*1	Cooling	kW	0.086	0.086	0.089
Power consumption (FXDQ-PBVET)*1	Cooling	kW	0.067	0.067	0.070
Casing	Galvanised steel plate				
Airflow rate (HH/H/L)		m ³ /min	8.0/7.2/6.4	8.0/7.2/6.4	8.0/7.2/6.4
		cfm	282/254/226	282/254/226	282/254/226
External static pressure		Pa	30-10*2		
Sound level (HH/H/L)*1*3		dB(A)	28/26/23		
Dimensions (HxWxD)		mm	200x700x620	200x700x620	200x700x620
Machine weight		kg	23.0	23.0	23.0
Piping connections	Liquid (Flare)	mm	φ6.4	φ6.4	φ6.4
	Gas (Flare)		φ12.7	φ12.7	φ12.7
	Drain		VP20 (External Dia, 26/Internal Dia, 20)		



900/1,100 mm width type

MODEL	with drain pump		FXDQ40NBVE	FXDQ50NBVE	FXDQ63NBVE
	without drain pump		FXDQ40NBVET	FXDQ50NBVET	FXDQ63NBVET
Power supply	1-phase, 220-240 V/220 V, 50/60 Hz				
Cooling capacity		kcal/h	3,900	4,800	6,100
		Btu/h	15,400	19,100	24,200
		kW	4.5	5.6	7.1
Power consumption (FXDQ-PBVE)*1	Cooling	kW	0.160	0.165	0.181
Power consumption (FXDQ-PBVET)*1	Cooling	kW	0.147	0.152	0.168
Casing	Galvanised steel plate				
Airflow rate (HH/H/L)		m ³ /min	10.5/9.5/8.5	12.5/11.0/10.0	16.5/14.5/13.0
		cfm	371/335/300	441/388/353	583/512/459
External static pressure		Pa	44-15*2		
Sound level (HH/H/L)*1*3		dB(A)	30/28/26	33/30/27	33/31/29
Dimensions (HxWxD)		mm	200x900x620	200x900x620	200x1,100x620
Machine weight		kg	27.0	28.0	31.0
Piping connections	Liquid (Flare)	mm	φ6.4	φ6.4	φ9.5
	Gas (Flare)		φ12.7	φ12.7	φ15.9
	Drain		VP20 (External Dia, 26/Internal Dia, 20)		

Note: Specifications are based on the following conditions;

- Cooling: Indoor temp.: 27°CDB, 19°CWB/inlet water temp.: 30°C, Equivalent piping length: 7.5 m, Level difference: 0 m.
 - Capacity of indoor unit is only for reference. Actual capacity of indoor unit is based on the total capacity index. (See Engineering Data Book for details.)
 - Sound level: Anechoic chamber conversion value, measured at a point 1.5 m downward from the unit centre.
- During actual operation, these values are normally somewhat higher as a result of ambient conditions.
- *1 : Values are based on the following conditions: FXDQ-PB: external static pressure of 10 Pa; FXDQ-NB: external static pressure of 15 Pa.
 - *2 : External static pressure is changeable to set by the remote controller. This pressure means "High static pressure - Standard". (Factory setting is 10 Pa for FXDQ-PB models and 15 Pa for FXDQ-NB models.)
 - *3 : The values of operation sound level represent those for rear-suction operation. Sound level values for bottom-suction operation can be obtained by adding 5 dB(A).

Slim Ceiling Mounted Duct Type (Compact Series)

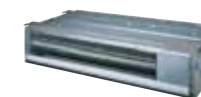

MODEL		FXDQ20SPV1	FXDQ25SPV1	FXDQ32SPV1	
Power supply		1-phase, 220-240 V, 50 Hz			
Cooling capacity	kcal/h	1,900	2,400	3,100	
	Btu/h	7,500	9,600	12,300	
	kW	2.2	2.8	3.6	
Power consumption*1	Cooling	kW	0.072	0.075	0.078
Casing		Galvanised steel plate			
Airflow rate (HH/H/L)		m ³ /min	8.7/7.6/6.5	9.0/8.0/7.0	10.0/9.0/8.0
		cfm	307/268/229	318/282/247	353/318/282
External static pressure		Pa	30-10*2		
Sound level (HH/H/L)*1*3		dB(A)	33/31/29		
Dimensions (HxWxD)		mm	200x700x450		
Machine weight		kg	17		
Piping connections	Liquid (Flare)	mm	φ6.4		
	Gas (Flare)		φ12.7		
	Drain		VP20 (External Dia, 26/Internal Dia, 20)		

MODEL		FXDQ40SPV1	FXDQ50SPV1	FXDQ63SPV1	
Power supply		1-phase, 220-240 V, 50 Hz			
Cooling capacity	kcal/h	3,900	4,800	6,100	
	Btu/h	15,400	19,100	24,200	
	kW	4.5	5.6	7.1	
Power consumption*1	Cooling	kW	0.180	0.180	0.196
Casing		Galvanised steel plate			
Airflow rate (HH/H/L)		m ³ /min	15.0/13.0/10.5	20.0/16.0/12.5	
		cfm	530/459/371	706/565/441	
External static pressure		Pa	50-20*2		
Sound level (HH/H/L)*1*3		dB(A)	35/33/31		
Dimensions (HxWxD)		mm	200x900x450	200x1,100x450	
Machine weight		kg	20	23	
Piping connections	Liquid (Flare)	mm	φ6.4	φ9.5	
	Gas (Flare)		φ12.7	φ15.9	
	Drain		VP20 (External Dia, 26/Internal Dia, 20)		

Note: Specifications are based on the following conditions;

- Cooling: Indoor temp.: 27°CDB, 19°CWB/inlet water temp.: 30°C, Equivalent piping length: 7.5 m, Level difference: 0 m.
 - Capacity of indoor unit is only for reference. Actual capacity of indoor unit is based on the total capacity index. (See Engineering Data Book for details.)
 - Sound level: Anechoic chamber conversion value, measured at a point 1.5 m downward from the unit centre.
- During actual operation, these values are normally somewhat higher as a result of ambient conditions.
- *1 : Values are based on the following conditions: FXDQ20-32SP: external static pressure of 10 Pa; FXDQ40-63SP: external static pressure of 20 Pa.
 - *2 : External static pressure is changeable to set by the remote controller. This pressure means "High static pressure - Standard". (Factory setting is 10 Pa for FXDQ20-32SP models and 20 Pa for FXDQ40-63SP models.)
 - *3 : The values of operation sound level represent those for rear-suction operation. Sound level values for bottom-suction operation can be obtained by adding 5 dB(A).

VRV Indoor Units

Middle Static Pressure Ceiling Mounted Duct Type



MODEL		FXSQ20PVE	FXSQ25PVE	FXSQ32PVE	FXSQ40PVE	FXSQ50PVE	
Power supply		1-phase, 220-240 V/220 V, 50/60 Hz					
Cooling capacity	kcal/h	1,900	2,400	3,100	3,900	4,800	
	Btu/h	7,500	9,600	12,300	15,400	19,100	
	kW	2.2	2.8	3.6	4.5	5.6	
Power consumption	Cooling	kW	0.058 *1	0.058 *1	0.066 *1	0.101 *1	0.075 *1
Casing		Galvanised steel plate					
Airflow rate (H/M/L)	m ³ /min	9/7.5/6.5	9/7.5/6.5	9.5/8/7	15/12.5/10.5	17/14.5/11.5	
	cfm	318/265/230	318/265/230	335/282/247	530/441/371	600/512/406	
External static pressure	Pa	30-150 (50) *2				50-150 (50) *2	
Sound level (H/M/L)	dB(A)	33/30/28		34/32/30	36/33/30	34/32/29	
Dimensions (HxWxD)	mm	245X550X800			245X700X800	245X1,000X800	
Machine weight	kg	25			27	35	
Piping connections	Liquid (Flare)	φ 6.4					
	Gas (Flare)	φ 12.7					
	Drain	VP25 (External Dia, 32/Internal Dia, 25)					

MODEL		FXSQ63PVE	FXSQ80PVE	FXSQ100PVE	FXSQ125PVE	FXSQ140PVE	
Power supply		1-phase, 220-240 V/220 V, 50/60 Hz					
Cooling capacity	kcal/h	6,100	7,700	9,600	12,000	13,800	
	Btu/h	24,200	30,700	38,200	47,800	54,600	
	kW	7.1	9.0	11.2	14.0	16.0	
Power consumption	Cooling	kW	0.106 *1	0.126 *1	0.151 *1	0.206 *1	0.222 *1
Casing		Galvanised steel plate					
Airflow rate (H/M/L)	m ³ /min	21/17.5/14.5	23/19.5/16	32/27/22.5	37/31.5/26	39/33.5/28	
	cfm	741/618/512	812/688/565	1,130/953/794	1,306/1,112/918	1,377/1,183/988	
External static pressure	Pa	50-150 (50) *2				50-140 (50) *2	
Sound level (H/M/L)	dB(A)	36/32/29	37.5/34/30	39/35/32	42/38.5/35	43/40/36	
Dimensions (HxWxD)	mm	245X1,000X800		245X1,400X800		245X1,550X800	
Machine weight	kg	35	37	46	47	52	
Piping connections	Liquid (Flare)	φ 9.5					
	Gas (Flare)	φ 15.9					
	Drain	VP25 (External Dia, 32/Internal Dia, 25)					

Note: Specifications are based on the following conditions;

- Cooling: Indoor temp.: 27°CDB, 19°CWB/inlet water temp.: 30°C, Equivalent piping length: 7.5 m, Level difference: 0 m.
- Capacity of indoor unit is only for reference. Actual capacity of indoor unit is based on the total capacity index. (See Engineering Data Book for details.)
- Sound level: Anechoic chamber conversion value, measured at a point 1.5 m downward from the unit centre. During actual operation, these values are normally somewhat higher as a result of ambient conditions.
- *1: Power consumption values are based on conditions of rated external static pressure.
- *2: External static pressure can be modified using a remote controller that offers thirteen (FXSQ20-40P), eleven (FXSQ50-125P) or ten (FXSQ140P) levels of control. These values indicate the lowest and highest possible static pressures. The rated static pressure is 50 Pa.

Ceiling Mounted Duct Type



MODEL		FXMQ20PVE	FXMQ25PVE	FXMQ32PVE	FXMQ40PVE	FXMQ50PVE	
Power supply		1-phase, 220-240 V/220 V, 50/60 Hz					
Cooling capacity	kcal/h	1,900	2,400	3,100	3,900	4,800	
	Btu/h	7,500	9,600	12,300	15,400	19,100	
	kW	2.2	2.8	3.6	4.5	5.6	
Power consumption	Cooling	kW	0.056 *1	0.056 *1	0.060 *1	0.151 *1	0.128 *1
Casing		Galvanised steel plate					
Airflow rate (HH/H/L)	m ³ /min	9/7.5/6.5	9/7.5/6.5	9.5/8/7	16/13/11	18/16.5/15	
	cfm	318/265/230	318/265/230	335/282/247	565/459/388	635/582/530	
External static pressure	Pa	30-100 (50) *2	30-100 (50) *2	30-100 (50) *2	30-160 (100) *2	50-200 (100) *2	
Sound level (HH/H/L)	dB(A)	33/31/29	33/31/29	34/32/30	39/37/35	41/39/37	
Dimensions (HxWxD)	mm	300X550X700	300X550X700	300X550X700	300X700X700	300X1,000X700	
Machine weight	kg	25	25	25	28	36	
Piping connections	Liquid (Flare)	φ 6.4					
	Gas (Flare)	φ 12.7					
	Drain	VP25 (External Dia, 32/Internal Dia, 25)					

MODEL		FXMQ63PVE	FXMQ80PVE	FXMQ100PVE	FXMQ125PVE	FXMQ140PVE	
Power supply		1-phase, 220-240 V/220 V, 50/60 Hz					
Cooling capacity	kcal/h	6,100	7,700	9,600	12,000	13,800	
	Btu/h	24,200	30,700	38,200	47,800	54,600	
	kW	7.1	9.0	11.2	14.0	16.0	
Power consumption	Cooling	kW	0.138 *1	0.185 *1	0.215 *1	0.284 *1	0.405 *1
Casing		Galvanised steel plate					
Airflow rate (HH/H/L)	m ³ /min	19.5/17.5/16	25/22.5/20	32/27/23	39/33/28	46/39/32	
	cfm	688/618/565	883/794/706	1,130/953/812	1,377/1,165/988	1,624/1,377/1,130	
External static pressure	Pa	50-200 (100) *2	50-200 (100) *2	50-200 (100) *2	50-200 (100) *2	50-140 (100) *2	
Sound level (HH/H/L)	dB(A)	42/40/38	43/41/39	43/41/39	44/42/40	46/45/43	
Dimensions (HxWxD)	mm	300X1,000X700	300X1,000X700	300X1,400X700	300X1,400X700	300X1,400X700	
Machine weight	kg	36	36	46	46	47	
Piping connections	Liquid (Flare)	φ 9.5					
	Gas (Flare)	φ 15.9					
	Drain	VP25 (External Dia, 32/Internal Dia, 25)					

Note: Specifications are based on the following conditions;

- Cooling: Indoor temp.: 27°CDB, 19°CWB/inlet water temp.: 30°C, Equivalent piping length: 7.5 m, Level difference: 0 m.
- Capacity of indoor unit is only for reference. Actual capacity of indoor unit is based on the total capacity index. (See Engineering Data Book for details.)
- Sound level: Anechoic chamber conversion value, measured at a point 1.5 m downward from the unit centre. During actual operation, these values are normally somewhat higher as a result of ambient conditions.
- *1: Power consumption values are based on conditions of rated external static pressure.
- *2: External static pressure can be modified using a remote controller that offers seven (FXMQ20-32P), thirteen (FXMQ40P), fourteen (FXMQ50-125P) or ten (FXMQ140P) levels of control. These values indicate the lowest and highest possible static pressures. The standard static pressure is 50 Pa for FXMQ20-32P and 100 Pa for FXMQ40-140P.

VRV Indoor Units

Ceiling Mounted Duct Type



MODEL		FXMQ200MAVE	FXMQ250MAVE
Power supply		1-phase, 220-240 V/220 V, 50/60 Hz	
Cooling capacity	kcal/h	19,300	24,100
	Btu/h	76,400	95,500
	kW	22.4	28.0
Power consumption	Cooling kW	1.294 *1	1.465 *1
Casing		Galvanised steel plate	
Airflow rate (H/L)	m ³ /min	58/50	72/62
	cfm	2,047/1,765	2,542/2,189
External static pressure	Pa	132-221 *2	191-270 *2
Sound level(H/L)	220 V dB(A)	48/45	48/45
	240 V dB(A)	49/46	49/46
Dimensions (HxWxD)	mm	470x1,380x1,100	470x1,380x1,100
Machine weight	kg	137	137
Piping connections	Liquid (Flare)	φ 9.5	φ 9.5
	Gas (Brazing)	φ 19.1	φ 22.2
	Drain	PS1B	

4-Way Flow Ceiling Suspended Type



MODEL		FXUQ71AVEB	FXUQ100AVEB
Power supply		1-phase, 220-240 V/220-230 V, 50/60 Hz	
Cooling capacity	kcal/h	6,900	9,600
	Btu/h	27,300	38,200
	kW	8.0	11.2
Power consumption	Cooling kW	0.090	0.200
Casing		Fresh white	
Airflow rate (H/M/L)	m ³ /min	22.5/19.5/16	31/26/21
	cfm	794/688/565	1,094/918/741
Sound level (H/M/L)	dB(A)	40/38/36	47/44/40
Dimensions (HxWxD)	mm	198x950x950	
Machine weight	kg	26	27
Piping connections	Liquid (Flare)	φ 9.5	
	Gas (Flare)	φ 15.9	
	Drain	VP20 (External Dia, 26/Internal Dia, 20)	

Note: Specifications are based on the following conditions;

- Cooling: Indoor temp.: 27°CDB, 19°CWB/inlet water temp.: 30°C, Equivalent piping length: 7.5 m, Level difference: 0 m.
- Capacity of indoor unit is only for reference. Actual capacity of indoor unit is based on the total capacity index. (See Engineering Data Book for details.)
- Sound level: (FXMQ-MA) Anechoic chamber conversion value, measured at a point 1.5 m downward from the unit centre. (FXUQ-A) Anechoic chamber conversion value, measured at a point 1 m in front of the unit and 1 m downward. During actual operation, these values are normally somewhat higher as a result of ambient conditions.

*1: Power consumption values are based on conditions of standard external static pressure.
 *2: External static pressure is changeable to change over the connectors inside electrical box, this pressure means "Standard-High static pressure".

Ceiling Suspended Type



MODEL		FXHQ32MAVE	FXHQ63MAVE	FXHQ100MAVE
Power supply		1-phase, 220-240 V/220 V, 50/60 Hz		
Cooling capacity	kcal/h	3,100	6,100	9,600
	Btu/h	12,300	24,200	38,200
	kW	3.6	7.1	11.2
Power consumption	Cooling kW	0.111	0.115	0.135
Casing		White (10Y9/0.5)		
Airflow rate (H/L)	m ³ /min	12/10	17.5/14	25/19.5
	cfm	424/353	618/494	883/688
Sound level (H/L)	dB(A)	36/31	39/34	45/37
Dimensions (HxWxD)	mm	195x960x680	195x1,160x680	195x1,400x680
Machine weight	kg	24.0	28.0	33.0
Piping connections	Liquid (Flare)	φ 6.4	φ 9.5	φ 9.5
	Gas (Flare)	φ 12.7	φ 15.9	φ 15.9
	Drain	VP20 (External Dia, 26/Internal Dia, 20)		

Wall Mounted Type



MODEL		FXAQ20PVE	FXAQ25PVE	FXAQ32PVE	FXAQ40PVE	FXAQ50PVE	FXAQ63PVE
Power supply		1-phase, 220-240 V/220 V, 50/60 Hz					
Cooling capacity	kcal/h	1,900	2,400	3,100	3,900	4,800	6,100
	Btu/h	7,500	9,600	12,300	15,400	19,100	24,200
	kW	2.2	2.8	3.6	4.5	5.6	7.1
Power consumption	Cooling kW	0.019	0.028	0.030	0.020	0.033	0.050
Casing		White (3.0Y8.5/0.5)					
Airflow rate (H/L)	m ³ /min	7.5/4.5	8/5	8.5/5.5	12/9	15/12	19/14
	cfm	265/159	282/177	300/194	424/318	530/424	671/494
Sound level (H/L)	dB(A)	35/31	36/31	38/31	39/34	42/37	47/41
Dimensions (HxWxD)	mm	290x795x238	290x795x238	290x795x238	290x1,050x238	290x1,050x238	290x1,050x238
Machine weight	kg	11.0	11.0	11.0	14.0	14.0	14.0
Piping connections	Liquid (Flare)	φ 6.4	φ 6.4	φ 6.4	φ 6.4	φ 6.4	φ 9.5
	Gas (Flare)	φ 12.7	φ 12.7	φ 12.7	φ 12.7	φ 12.7	φ 15.9
	Drain	VP13 (External Dia, 18/Internal Dia, 13)					

Note: Specifications are based on the following conditions;

- Cooling: Indoor temp.: 27°CDB, 19°CWB/inlet water temp.: 30°C, Equivalent piping length: 7.5 m, Level difference: 0 m.
- Capacity of indoor unit is only for reference. Actual capacity of indoor unit is based on the total capacity index. (See Engineering Data Book for details.)
- Sound level: Anechoic chamber conversion value, measured at a point 1 m in front of the unit and 1 m downward. During actual operation, these values are normally somewhat higher as a result of ambient conditions.

VRV Indoor Units

Floor Standing Type/Concealed Floor Standing Type

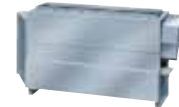

FXNQ

MODEL		FXLQ20MAVE	FXLQ25MAVE	FXLQ32MAVE	FXLQ40MAVE	FXLQ50MAVE	FXLQ63MAVE	
		FXNQ20MAVE	FXNQ25MAVE	FXNQ32MAVE	FXNQ40MAVE	FXNQ50MAVE	FXNQ63MAVE	
Power supply		1-phase, 220-240 V/220 V, 50/60 Hz						
Cooling capacity	kcal/h	1,900	2,400	3,100	3,900	4,800	6,100	
	Btu/h	7,500	9,600	12,300	15,400	19,100	24,200	
	kW	2.2	2.8	3.6	4.5	5.6	7.1	
Power consumption	Cooling	kW	0.049	0.049	0.090	0.090	0.110	0.110
Casing		FXLQ: Ivory white (5Y7.5/1)/FXNQ: Galvanised steel plate						
Airflow rate (H/L)	m ³ /min	7/6	7/6	8/6	11/8.5	14/11	16/12	
	cfm	247/212	247/212	282/212	388/300	494/388	565/424	
Sound level (H/L)	220 V	dB(A)	35/32	35/32	35/32	38/33	39/34	40/35
	240 V		37/34	37/34	37/34	40/35	41/36	42/37
Dimensions (HxWxD)	FXLQ	mm	600x1,000x222	600x1,000x222	600x1,140x222	600x1,140x222	600x1,420x222	600x1,420x222
	FXNQ		610x930x220	610x930x220	610x1,070x220	610x1,070x220	610x1,350x220	610x1,350x220
Machine weight	FXLQ	kg	25.0	25.0	30.0	30.0	36.0	36.0
	FXNQ		19.0	19.0	23.0	23.0	27.0	27.0
Piping connections	Liquid (Flare)	mm	φ6.4	φ6.4	φ6.4	φ6.4	φ6.4	φ9.5
	Gas (Flare)		φ12.7	φ12.7	φ12.7	φ12.7	φ12.7	φ15.9
	Drain		210.D.					

Note: Specifications are based on the following conditions:

- Cooling: Indoor temp.: 27°CDB, 19°CWB/inlet water temp.: 30°C, Equivalent piping length: 7.5 m, Level difference: 0 m.
- Capacity of indoor unit is only for reference. Actual capacity of indoor unit is based on the total capacity index. (See Engineering Data Book for details.)
- Sound level: Anechoic chamber conversion value, measured at a point 1.5 m in front of the unit at a height of 1.5 m. During actual operation, these values are normally somewhat higher as a result of ambient conditions.

Floor Standing Duct Type



MODEL		FXVQ125NY1	FXVQ200NY1	FXVQ250NY1	FXVQ400NY1	FXVQ500NY1	FXVQ500NY16	
Power supply		3-phase 4-wire system, 380-415 V, 50 Hz						
Cooling capacity	kcal/h	12,000	19,300	24,100	38,700	48,200		
	Btu/h	47,800	76,400	95,500	154,000	191,000		
	kW	14.0	22.4	28.0	45.0	56.0		
Power consumption	kW	0.53	1.33	1.61	3.97	2.62	5.25	
Casing colour		Ivory white (5Y7.5/1)						
Dimensions (HxWxD)	mm	1,670x750x510	1,670x950x510	1,670x1,170x510	1,900x1,170x720	1,900x1,470x720		
Machine weight	kg	118	144	169	236	281	306	
Sound level *1	dB(A)	52	56	60	65	62	67	
Piping connections	Liquid	φ9.5 (Brazing)		φ12.7 (Brazing)		φ15.9 (Brazing)		
	Gas	φ15.9 (Brazing)	φ19.1 (Brazing)	φ22.2 (Brazing)	φ28.6 (Brazing)			
	Drain	Rp1 (PS 1B internal thread)						
Air filter	Type	Long-life filter (anti-mould resin net)						
Fan	Motor output	kW	0.75	1.5		3.7		
	Airflow rate	m ³ /min	43	69	86	134	165	172
		cfm	1,518	2,436	3,036	4,730	5,825	6,072
	External static pressure *2	Pa	152	217	281	420	142	469
	Drive system	Belt drive system						

Note: Specifications are based on the following conditions:

- Cooling: Indoor temp.: 27°CDB, 19°CWB/inlet water temp.: 30°C, Equivalent piping length: 7.5 m, Level difference: 0 m.
- Capacity of indoor unit is only for reference. Actual capacity of indoor unit is based on the total capacity index. (See Engineering Data Book for details.)
- *1: Sound level: measured when the air discharge outlet duct (2 m) is attached (anechoic chamber conversion value). It increases by approximately 5 dB(A) when the plenum chamber is installed to deliver direct airflow.
- *2: The value is the external static pressure with standard pulley.

Residential indoor units with connection to BP units

Slim Ceiling Mounted Duct Type

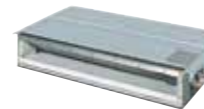
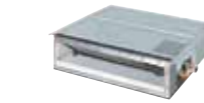

MODEL		FDKS25EAVMB	FDKS35EAVMB	FDKS25CAVMB	FDKS35CAVMB	FDKS50CVMB	FDKS60CVMB
Power supply		1-phase, 220-240 V/220-230 V, 50/60 Hz					
Airflow rates (H)	m ³ /min (cfm)	8.7 (307)	9.5 (335)	10.0 (353)	12.0 (424)	16.0 (565)	
Sound levels (H/L/SL)*	dB (A)	35/31/29			37/33/31		38/34/32
Fan speed		5 steps, quiet and automatic					
Temperature control		Microcomputer control					
Dimensions (HxWxD)	mm	200x700x620		200x900x620		200x1,100x620	
Machine weight	kg	21	25		27	30	
Piping connections	Liquid (Flare)	φ6.4					
	Gas (Flare)	φ9.5				φ12.7	
	Drain	VP20 (External Dia. 26/Internal Dia. 20)					
Heat insulation		Both liquid and gas pipes					
External static pressure	Pa	30			40		

Note: * The operation sound level values represent those for rear-suction operation and an external static pressure of 30 Pa for FDKS-EA and 40 Pa for FDKS-C. Sound level values for bottom-suction operation can be obtained by adding 6 dB (A) for FDKS-EA and 5 dB (A) for FDKS-C.

Wall Mounted Type



MODEL		FTKJ25NVMW	FTKJ25NVMS	FTKJ35NVMW	FTKJ35NVMS	FTKJ50NVMW	FTKJ50NVMS
Power supply		1-phase, 220-240 V/220-230 V, 50/60 Hz					
Front panel colour		White	Silver	White	Silver	White	Silver
Airflow rates (H)	m ³ /min (cfm)	8.9 (313)		10.9 (385)			
Sound levels (H/L/SL)	dB (A)	38/25/19		45/26/20		46/35/29	
Fan speed		5 steps, quiet and automatic					
Temperature control		Microcomputer control					
Dimensions (HxWxD)	mm	303x998x212					
Machine weight	kg	12					
Piping connections	Liquid (Flare)	φ6.4					
	Gas (Flare)	φ9.5				φ12.7	
	Drain	φ18.0					
Heat insulation		Both liquid and gas pipes					

Wall Mounted Type



MODEL		FTKS25DVM	FTKS35DVM	FTKS50BVM	FTKS50FVM	FTKS60FVM	FTKS71FVM
Power supply		1-phase, 220-240 V/220-230 V, 50/60 Hz					
Front panel colour		White					
Airflow rates (H)	m ³ /min (cfm)	8.7 (307)	8.9 (314)	11.4 (402)	14.7 (519)	16.2 (572)	17.4 (614)
Sound levels (H/L/SL)	dB (A)	37/25/22	39/26/23	44/35/32	43/34/31	45/36/33	46/37/34
Fan speed		5 steps, quiet and automatic					
Temperature control		Microcomputer control					
Dimensions (HxWxD)	mm	283x800x195		290x795x238		290x1,050x238	
Machine weight	kg	9			12		
Piping connections	Liquid (Flare)	φ6.4					
	Gas (Flare)	φ9.5		φ12.7		φ15.9	
	Drain	φ18.0					
Heat insulation		Both liquid and gas pipes					

Residential indoor units with connection to BP units

BP Units for connection to residential indoor units



MODEL		BPMKS967A3	BPMKS967A2
Power supply		1-phase, 220-240 V/220-230 V, 50/60 Hz	
Number of ports		3 (connectable to 1-3 indoor units)	2 (connectable to 1-2 indoor units)
Power consumption	W	10	
Running current	A	0.05	
Dimensions (HxWxD)		mm 180x294 (+356*)x350	
Machine weight	kg	8	7.5
Number of wiring connections		3 for power supply (including earth wiring), 2 for interunit wiring (outside unit-BP, BP-BP), 4 for interunit wiring (BP-indoor unit)	
Piping connections (Brazeing)	Liquid	Main	mm $\phi 9.5 \times 1$
		Branch	mm $\phi 6.4 \times 3$ $\phi 6.4 \times 2$
	Gas	Main	mm $\phi 19.1 \times 1$
		Branch	mm $\phi 15.9 \times 3$ $\phi 15.9 \times 2$
Heat insulation		Both liquid and gas pipes	
Connectable indoor units		2.5 kW class to 7.1 kW class residential indoor units	
Min. rated capacity of connectable indoor units	kW	2.5	
Max. rated capacity of connectable indoor units	kW	20.8	14.2

Note: * Total auxiliary piping length.

Outside Unit Combinations

For connection of only VRV indoor units

HP	kW	Capacity index	Model	Combination	Total capacity index of connectable indoor units*2	Maximum number of connectable indoor units
6	16.0	150	RWEYQ6T	RWEYQ6T x 1	75 to 195	9
8	22.4	200	RWEYQ8T	RWEYQ8T x 1	100 to 260	13
10	28.0	250	RWEYQ10T	RWEYQ10T x 1	125 to 325	16
12	33.5	300	RWEYQ12T	RWEYQ12T x 1	150 to 390	19
14	38.4	350	RWEYQ14T ⁻¹	RWEYQ6T + RWEYQ8T	175 to 455	22
16	44.8	400	RWEYQ16T ⁻¹	RWEYQ8T x 2	200 to 520	26
18	50.4	450	RWEYQ18T ⁻¹	RWEYQ8T + RWEYQ10T	225 to 585	29
20	56.0	500	RWEYQ20T ⁻¹	RWEYQ10T x 2	250 to 650	32
22	61.5	550	RWEYQ22T ⁻¹	RWEYQ10T + RWEYQ12T	275 to 715	35
24	67.0	600	RWEYQ24T ⁻¹	RWEYQ12T x 2	300 to 780	36
26	72.8	650	RWEYQ26T ⁻¹	RWEYQ8T x 2 + RWEYQ10T	325 to 845	
28	78.4	700	RWEYQ28T ⁻¹	RWEYQ8T + RWEYQ10T x 2	350 to 910	
30	84.0	750	RWEYQ30T ⁻¹	RWEYQ10T x 3	375 to 975	52
32	89.5	800	RWEYQ32T ⁻¹	RWEYQ10T x 2 + RWEYQ12T	400 to 1,040	
34	95.0	850	RWEYQ34T ⁻¹	RWEYQ10T + RWEYQ12T x 2	425 to 1,105	55
36	101	900	RWEYQ36T ⁻¹	RWEYQ12T x 3	450 to 1,170	58

*1. An outside unit multi connection piping kit (option) is necessary for multiple connections of 14 HP systems and above.
*2. Total capacity index of connectable indoor units must be 50%–130% of the capacity index of the outside units.

For connection of only residential indoor units

Model name ⁻¹	kW	HP	Capacity index	Total capacity index of connectable indoor units ⁻²			Maximum number of connectable indoor units
				Combination (%) ⁻²			
				50% ⁻²	100%	130%	
RWEYQ6T	16.0	6 HP	150	75	150	195	9
RWEYQ8T	22.4	8 HP	200	100	200	260	13
RWEYQ10T	28.0	10 HP	250	125	250	325	16
RWEYQ12T	33.5	12 HP	300	150	300	390	19

*1. Only single outdoor unit (RWEYQ6-12T) can be connected.
*2. Total capacity index of connectable indoor units must be 50%–130% of the capacity index of the outside unit.

Outside Units

Cooling Only

MODEL		RWEYQ6TYM	RWEYQ8TYM	RWEYQ10TYM	RWEYQ12TYM	RWEYQ14TYM	RWEYQ16TYM	RWEYQ18TYM	RWEYQ20TYM	RWEYQ22TYM	RWEYQ24TYM
Combination units		ñ	ñ	ñ	ñ	ñ	ñ	ñ	ñ	ñ	ñ
Power supply		3-phase 4-wire system, 380-415 V/380 V, 50/60 Hz				3-phase 4-wire system, 380-415 V/380 V, 50/60 Hz					
Cooling capacity	kcal/h	13,800	19,300	24,100	28,800	33,000	38,500	43,300	48,200	52,900	57,600
	Btu/h	54,600	76,400	95,500	114,000	131,000	153,000	172,000	191,000	210,000	229,000
	kW	16.0	22.4	28.0	33.5	38.4	44.8	50.4	56.0	61.5	67.0
Power consumption	kW	2.58	3.86	5.43	7.33	6.44	7.72	9.29	10.9	12.8	14.7
Casing colour		Ivory white (5Y7.5/1)				Ivory white (5Y7.5/1)					
Dimensions(HxWxD)		1,000 × 780 × 550				(1,000 × 780 × 550) × 2					
Compressor	Type	Hermetically sealed scroll type									
	Motor output	kW	1.9	2.8	3.7	4.7	1.9 + 2.8	2.8 × 2	2.8 + 3.7	3.7 × 2	3.7 + 4.7
Refrigerant piping connections	Liquid	φ9.5 (Flare)				φ12.7 (Flare)		φ15.9 (Flare)		φ19.1 (Flare)	
	Suction gas *1	φ19.1 (Brazeing)				φ22.2 (Brazeing)		φ28.6 (Brazeing)		φ19.1 (Flare)	
	High and low pressure gas	φ19.1 (Brazeing) *2				φ22.2 (Brazeing) *2		φ28.6 (Brazeing) *2			
Water piping connections	Water inlet	PT1 1/4B intenal thread				(PT1 1/4B) × 2 intenal thread					
	Water outlet	PT1 1/4B intenal thread				(PT1 1/4B) × 2 intenal thread					
	Drain outlet	PS1/2B intenal thread				(PS1/2B) × 2 intenal thread					
Machine weight (Operating weight)	kg	146 (148)		147 (149)		146 × 2 (148 × 2)		146 + 147 (148 + 149)		147 × 2 (149 × 2)	
Sound level	dB(A)	49	50	51	53	53		54		55	56
Operation range (Inlet water temp.)	°C	10 to 45				10 to 45					
Capacity control	%	23-100		19-100		23-100		20-100		19-100	
Refrigerant charge	Type	R-410A									
	Charge	kg	3.5		4.2		3.5 + 3.5		3.5 + 4.2		4.2 + 4.2

MODEL		RWEYQ26TYM	RWEYQ28TYM	RWEYQ30TYM	RWEYQ32TYM	RWEYQ34TYM	RWEYQ36TYM
Combination units		RWEYQ8TYM	RWEYQ8TYM	RWEYQ10TYM	RWEYQ10TYM	RWEYQ10TYM	RWEYQ12TYM
Power supply		3-phase 4-wire system, 380-415 V/380 V, 50/60 Hz			3-phase 4-wire system, 380-415 V/380 V, 50/60 Hz		
Cooling capacity	kcal/h	62,600	67,400	72,200	77,000	81,700	86,900
	Btu/h	248,000	268,000	287,000	305,000	324,000	345,000
	kW	72.8	78.4	84.0	89.5	95.0	101
Power consumption	kW	13.2	14.7	16.3	18.2	20.1	22.0
Casing colour		Ivory white (5Y7.5/1)					
Dimensions(HxWxD)		(1,000 × 780 × 550) × 3					
Compressor	Type	Hermetically sealed scroll type					
	Motor output	kW	2.8 × 2 + 3.7	2.8 + 3.7 × 2	3.7 × 3	3.7 × 2 + 4.7	3.7 + 4.7 × 2
Refrigerant piping connections	Liquid	φ19.1 (Flare)					
	Suction gas *1	φ34.9 (Brazeing)					
	High and low pressure gas	φ34.9 (Brazeing) *2					
Water piping connections	Water inlet	(PT1 1/4B) × 3 intenal thread					
	Water outlet	(PT1 1/4B) × 3 intenal thread					
	Drain outlet	(PS1/2B) × 3 intenal thread					
Machine weight (Operating weight)	kg	146 × 2 + 147 (148 × 2 + 149)		146 + 147 × 2 (148 + 149 × 2)		147 × 3 (149 × 3)	
Sound level	dB(A)	55		56		57	58
Operation range (Inlet water temp.)	°C	10 to 45					
Capacity control	%	21-100		20-100		19-100	
Refrigerant charge	Type	R-410A					
	Charge	kg	3.5 + 3.5 + 4.2		3.5 + 4.2 + 4.2		4.2 + 4.2 + 4.2

Note: 1. Specifications are based on the following conditions ;
 •Cooling:Indoor temp.: 27°CDB, 19°CWB/inlet water temp.: 30°C, Equivalent piping length: 7.5 m, Level difference: 0 m.
 2. This unit cannot be installed in the outdoors. Install indoors (Machine room, etc).

3. Hold ambient temperature at 0-40°C and humidity at 80%RH or less.
 Heat rejection from the casing: 0.51 kW/6-8 HP/hour, 0.58 kW/10-12 HP/hour.
 4. Connectable to closed type cooling tower only.
 *1: In the case of cooling only system, suction gas pipe is not used.
 *2: In the case of cooling only system.

•Be sure to refer to the Engineering Data Book for facility design.

VRV Indoor Units

Ceiling Mounted Cassette (Round Flow with Sensing) Type

No.	Item	Type	FXFQ25S	FXFQ32S	FXFQ40S	FXFQ50S	FXFQ63S	FXFQ80S	FXFQ100S	FXFQ125S
1	Decoration panel					BYCQ125B-W1				
2	Sealing material of air discharge outlet					KDBHQ55B140				
3	Panel spacer					KDBP55H160FA				
4	Filter related	High efficiency filter unit 65%				KAFP556C80			KAFP556C160	
		High efficiency filter unit 90%				KAFP557C80			KAFP557C160	
		Replacement high efficiency filter 65%				KAFP552B80			KAFP552B160	
		Replacement high efficiency filter 90%				KAFP553B80			KAFP553B160	
		Filter chamber							KDDFP55C160	
		Long life replacement filter							KAFP551K160	
		Ultra long-life filter unit							KAFP55C160	
5	Fresh air intake kit	Replacement ultra long-life filter							KAFP55H160H	
		Chamber type	Without T-duct joint	KDDQ55B140 (Components: KDDP55C160-1, KDDQ55B140-2) *1						
		With T-duct joint	KDDP55B160K (Components: KDDP55C160-1, KDDP55B160K2) *1							
		Direct installation type	KDDP55X160A							
6	Branch duct chamber					KDJP55B80			KDJP55B160	
7	Insulation kit for high humidity					KDTP55K80			KDTP55K160	

Note: *1. Please order using the names of both components instead of set name.

Ceiling Mounted Cassette (Round Flow) Type

No.	Item	Type	FXFQ25LU	FXFQ32LU	FXFQ40LU	FXFQ50LU	FXFQ63LU	FXFQ80LU	FXFQ100LU	FXFQ125LU
1	Decoration panel					BYCP125K-W1				
2	Sealing material of air discharge outlet					KDBH55K160F				
3	Panel spacer					KDBP55H160FA				
4	Filter related	High efficiency filter unit 65%				KAFP556C80			KAFP556C160	
		High efficiency filter unit 90%				KAFP557C80			KAFP557C160	
		Replacement high efficiency filter 65%				KAFP552B80			KAFP552B160	
		Replacement high efficiency filter 90%				KAFP553B80			KAFP553B160	
		Filter chamber							KDDFP55C160	
		Long life replacement filter							KAFP551K160	
		Ultra long-life filter unit							KAFP55C160	
5	Fresh air intake kit	Replacement ultra long-life filter							KAFP55H160H	
		Chamber type	Without T-duct joint	KDDP55B160 (Components: KDDP55C160-1, KDDP55B160-2) *1						
		With T-duct joint	KDDP55B160K (Components: KDDP55C160-1, KDDP55B160K2) *1							
		Direct installation type	KDDP55X160A							
6	Branch duct chamber					KDJP55B80			KDJP55B160	
7	Chamber connection kit					KKSJ55KA160				
8	Insulation kit for high humidity					KDTP55K80			KDTP55K160	

Note: *1. Please order using the names of both components instead of set name.

Ceiling Mounted Cassette (Compact Multi Flow) Type

No.	Item	Type	FXZQ20M	FXZQ25M	FXZQ32M	FXZQ40M	FXZQ50M
1	Decoration panel				BYFQ60B3W1		
2	Sealing material of air discharge outlet				KDBH44BA60		
3	Panel spacer				KDBQ44BA60A		
4	Replacement long-life filter				KAFQ441BA60		
5	Fresh air intake kit	Direct installation type			KDDQ44XA60		

Ceiling Mounted Cassette (Double Flow) Type

No.	Item	Type	FXCQ20M FXCQ25M FXCQ32M	FXCQ40M	FXCQ50M	FXCQ63M	FXCQ80M	FXCQ125M
1	Decoration panel		BYBC32G-W1	BYBC50G-W1	BYBC63G-W1	BYBC125G-W1		
2	Filter related	High efficiency filter 65% *1	KAFJ532G36	KAFJ532G56	KAFJ532G80	KAFJ532G160		
		High efficiency filter 90% *1	KAFJ533G36	KAFJ533G56	KAFJ533G80	KAFJ533G160		
		Filter chamber bottom suction	KDDFJ53G36	KDDFJ53G56	KDDFJ53G80	KDDFJ53G160		
		Long life replacement filter	KAFJ531G36	KAFJ531G56	KAFJ531G80	KAFJ531G160		

Note: *1 Filter chamber is required if installing high efficiency filter.

Ceiling Mounted Cassette Corner Type

No.	Item	Type	FXKQ25MA	FXKQ32MA	FXKQ40MA	FXKQ63MA
1	Panel related	Decoration panel		BYK45FJW1		BYK71FJW1
		Panel spacer		KPBJ52F56W		KPBJ52F80W
2	Air inlet and air discharge outlet related	Long life replacement filter		KAFJ521F56		KAFJ521F80
		Air discharge grille		K-HV7AW		K-HV9AW
		Air discharge blind panel		KDBJ52F56W		KDBJ52F80W
		Flexible duct (with shutter)		KFDJ52FA56		KFDJ52FA80

Slim Ceiling Mounted Duct Type (Standard Series)

No.	Item	Type	FXDQ20PB	FXDQ25PB	FXDQ32PB	FXDQ40NB	FXDQ50NB	FXDQ63NB
1	Insulation kit for high humidity		KDT25N32			KDT25N50		KDT25N63

Middle Static Pressure Ceiling Mounted Duct Type

No.	Item	Type	FXSQ20P FXSQ25P FXSQ32P	FXSQ40P	FXSQ50P FXSQ63P FXSQ80P	FXSQ100P FXSQ125P	FXSQ140P	
1	High efficiency filter *1	65%	KAFP632B36	KAFP632B56	KAFP632B80	KAFP632B160	KAF632B160B	
		90%	KAFP633B36	KAFP633B56	KAFP633B80	KAFP633B160	KAF633B160B	
2	Filter chamber (for rear suction) *1		KDDFP63B36	KDDFP63B56	KDDFP63B80	KDDFP63B160	KDDF63B160B	
3	Long-life filter *1		KAFP631B36	KAFP631B56	KAFP631B80	KAFP631B160	KAF631B160B	
4	Service panel	White	KTBJ25K36W	KTBJ25K56W	KTBJ25K80W	KTBJ25K160W		
		Fresh white	KTBJ25K36F	KTBJ25K56F	KTBJ25K80F	KTBJ25K160F		
		Brown	KTBJ25K36T	KTBJ25K56T	KTBJ25K80T	KTBJ25K160T		
5	Air discharge adaptor		KDAP25A36A	KDAP25A56A	KDAP25A71A	KDAP25A140A	KDAP25A160A *2	
6	Shield plate for side plate		KDBD63A160					-

Note: *1. If installing high efficiency filter and long-life filter to the unit, filter chamber is required.

*2. This option is a set of KDAP25A140A and KDBHP37A160.

Ceiling Mounted Duct Type

No.	Item	Type	FXMQ20P FXMQ25P FXMQ32P	FXMQ40P	FXMQ50P FXMQ63P FXMQ80P	FXMQ100P FXMQ125P FXMQ140P	FXMQ200MA FXMQ250MA
1	Drain pump kit						KDU30L250VE
2	High efficiency filter	65%	KAF372AA36	KAF372AA56	KAF372AA80	KAF372AA160	KAFJ372L280
		90%	KAF373AA36	KAF373AA56	KAF373AA80	KAF373AA160	KAFJ373L280
3	Filter chamber		KDDF37AA36	KDDF37AA56	KDDF37AA80	KDDF37AA160	KDJ3705L280
4	Long life replacement filter		KAF371AA36	KAF371AA56	KAF371AA80	KAF371AA160	KAFJ371L280
5	Long life filter chamber kit		KAF375AA36	KAF375AA56	KAF375AA80	KAF375AA160	
6	Service panel	White	KTBJ25K36W	KTBJ25K56W	KTBJ25K80W	KTBJ25K160W	
		Fresh white	KTBJ25K36F	KTBJ25K56F	KTBJ25K80F	KTBJ25K160F	
		Brown	KTBJ25K36T	KTBJ25K56T	KTBJ25K80T	KTBJ25K160T	
7	Air discharge adaptor		KDAJ25K36A	KDAJ25K56A	KDAJ25K71A	KDAJ25K140A	

4-Way Flow Ceiling Suspended Type

No.	Item	Type	FXUQ71A	FXUQ100A
1	Sealing material of air discharge outlet			KDBHP49B140
2	Decoration panel for air discharge			KDBTP49B140
3	Replacement long-life filter			KAFP551K160

Ceiling Suspended Type

No.	Item	Type	FXHQ32MA	FXHQ63MA	FXHQ100MA
1	Drain pump kit		KDU50N60VE	KDU50N125VE	
2	Replacement long-life filter (Resin net)		KAF501DA56	KAF501DA80	KAF501DA112
3	L-type piping kit (for upward direction)		KHFP5MA63	KHFP5MA160	

Wall Mounted Type

No.	Item	Type	FXAQ20P	FXAQ25P	FXAQ32P	FXAQ40P	FXAQ50P	FXAQ63P
1	Drain pump kit		K-KDU572EVE					

VRV Indoor Units

Floor Standing Type

No.	Item	Type	FXLQ20MA	FXLQ25MA	FXLQ32MA	FXLQ40MA	FXLQ50MA	FXLQ63MA
1	Long life replacement filter		KAFJ361K28		KAFJ361K45		KAFJ361K71	

Concealed Floor Standing Type

No.	Item	Type	FXNQ20MA	FXNQ25MA	FXNQ32MA	FXNQ40MA	FXNQ50MA	FXNQ63MA
1	Long life replacement filter		KAFJ361K28		KAFJ361K45		KAFJ361K71	

Floor Standing Duct Type

No.	Item	Type	FXVQ125N	FXVQ200N	FXVQ250N	FXVQ400N	FXVQ500N		
1	Replacement long life filter		KAFJ261L140	KAFJ261L224	KAFJ261L280	KAFJ261M450	KAFJ261M560		
2	Ultra long-life filter		-				KAFSJ9A400	KAFSJ9A560	
3	Discharge and Suction Front suction filter chamber for high efficiency filter	Front suction base flange	KD-9A140	KD-9A200	KD-9A280	KD-9A400	KD-9A560		
4		Suction grille	KDGF-9A140	KDGF-9A200	KDGF-9A280	KDGF-9A400	KDGF-9A560		
5		Filter chamber for high efficiency filter	Replacement long-life filter *1, 2, 3	65% *1, 3	KAF-91A140	KAF-91A200	KAF-91A280	KAF-91A400	KAF-91A560
6				90% *2, 3	KAF-92A140	KAF-92A200	KAF-92A280	KAF-92A400	KAF-92A560
7					KAF-93A140	KAF-93A200	KAF-93A280	KAF-93A400	KAF-93A560
8			Filter chamber *1, 2	KDDF-9A140	KDDF-9A200	KDDF-9A280	KDDF-9A400	KDDF-9A560	
9		Plenum chamber *4		KPCJ140A	KPC5J	KPC8J	KPCJ400A	KPC15JA	
10		Pulley for plenum chamber *4		KPP8JA	KPP9JA	KPP10JA	-		
11	Fresh air intake kit		KD106D10			KDFJ906A560			
12	Rear suction kit		KDFJ905A140	KDFJ905A200	KDFJ905A280	KDFJ905A400	KDFJ905A560		
13	Discharge grille for plenum side		KD101A10			KD101A20			
14	Wood base		KKWJ9A140	KWF1G5P	KWF1G8P	KKWJ9A400	KWF1G15		
15	Vibration isolating frame		K-ABSG1406A	K-ABSG1407A	K-ABSG1408A	K-ABSG1409A	K-ABSG1410A		

- *1. When ordering a filter chamber for high efficiency filter (65%), please order with all the respective parts.
- *2. When ordering a filter chamber for high efficiency filter (90%), please order with all the respective parts.
- *3. When replacing with a new filter, please order the replacement filters with the corresponding filter model name.
- *4. Use the plenum chamber and pulley for plenum chamber in combination.

Residential Indoor Units with connection to BP units

Slim Ceiling Mounted Duct Type

No.	Item	Type	FDKS25EAVMB	FDKS35EAVMB	FDKS25CAVMB	FDKS35CAVMB	FDKS50CVMB	FDKS60CVMB
1	Insulation kit for high humidity		KDT25N32		KDT25N50		KDT25N63	

Wall Mounted Type

No.	Item	Type	FTKJ25NVMW FTKJ25NVMS	FTKJ35NVMW FTKJ35NVMS	FTKJ50NVMW FTKJ50NVMS	FTKS25DVM FTKS35DVM	FTKS50BVMA	FTKS50FVM FTKS60FVM FTKS71FVM
1	Titanium apatite photocatalytic air-purifying filter		KAF970A46			KAF952A42		KAF952B42

Note: Filter is a standard accessory. It should be replaced approximately 3 years.

BP Units for connection to residential indoor units

No.	Item	Type	BPMKS967A2	BPMKS967A3
1	REFNET joint		KHRP26A22T	

Note: A single BP unit does not require a REFNET joint. 2 BP units require only 1 REFNET joint, and 3 BP units require only 2 REFNET joints.

Outside Units

Cooling Only

No.	Item	Type	RWEYQ6T RWEYQ8T RWEYQ10T RWEYQ12T	RWEYQ14T RWEYQ16T RWEYQ18T RWEYQ20T RWEYQ22T RWEYQ24T	RWEYQ26T RWEYQ28T RWEYQ30T RWEYQ32T RWEYQ34T RWEYQ36T
1	Distributive piping	REFNET header	KHRP25M33H (Max. 8 branch), KHRP26M22H (Max. 4 branch), KHRP26M33H (Max. 8 branch)	KHRP25M33H (Max. 8 branch), KHRP25M72H (Max. 8 branch), KHRP26M22H (Max. 4 branch), KHRP26M33H (Max. 8 branch), KHRP26M72H (Max. 8 branch)	KHRP25M33H (Max. 8 branch), KHRP25M72H (Max. 8 branch), KHRP25M73H (Max. 8 branch), KHRP26M22H (Max. 4 branch), KHRP26M33H (Max. 8 branch), KHRP26M72H (Max. 8 branch), KHRP26M73H (Max. 8 branch)
		REFNET joint	KHRP25A22T, KHRP25A33T, KHRP26A22T, KHRP26A33T	KHRP25A22T, KHRP25A33T, KHRP25A72T, KHRP26A22T, KHRP26A33T, KHRP26A72T	KHRP25A22T, KHRP25A33T, KHRP25A72T, KHRP25A73T, KHRP26A22T, KHRP26A33T, KHRP26A72T, KHRP26A73T
2	Outside unit multi connection piping kit		-		BHFP22MA56
3	External control adaptor				DTA104A62
4	Strainer kit				BWU26A15, BWU26A20

Strainer kit specifications

Model		BWU26A15	BWU26A20
Pressure resistance	MPa	1.47	1.96
Mesh size		50	50
Connection diameter		PT1 1/4B internal thread	PT1 1/4B internal thread

Control Systems

Operation Control System Optional Accessories

For VRV indoor unit use

No.	Item	Type	Model No.						
			FXFQ-S	FXFQ-LU	FXZQ-M	FXCQ-M	FXKQ-MA	FXDQ-PB FXDQ-NB	FXDQ-SP
1	Remote controller	Wireless	BRC7F635F		BRC7E531W	BRC4C67	BRC4C63	BRC4C66	
		Wired	BRC1C62						
2	Navigation remote controller (Wired remote controller)		BRC1E62 Note 7						
3	Simplified remote controller (Exposed type)		BRC2C51						
4	Remote controller for hotel use (Concealed type)		BRC3A61						
5	Adaptor for wiring		★KRP1C63	★KRP1BA57	★KRP1B61	KRP1B61	★KRP1B56	—	
6-1	Wiring adaptor for electrical appendices (1)		★KRP2A62	★KRP2A62	★KRP2A61	KRP2A61	★KRP2A53	—	
6-2	Wiring adaptor for electrical appendices (2)		★KRP4AA53	★KRP4AA53	★KRP4AA51	KRP4AA51	★KRP4A54	—	
7	Remote sensor (for indoor temperature)		KRCS01-4B	KRCS01-1B	KRCS01-1B				
8	Installation box for adaptor PCB☆		Note 2, 3 KRP1H98A	Note 4, 6 KRP1BA101	Note 2, 3 KRP1B96	—	Note 4, 6 KRP1BA101	—	
9	External control adaptor for outdoor unit		★DTA104A62	★DTA104A62	★DTA104A61	DTA104A61	★DTA104A53	—	
10	Adaptor for multi tenant		★DTA114A61	—					

No.	Item	Type	Model No.							
			FXSQ-P	FXMQ-P	FXMQ-MA	FXUQ-A	FXHQ-MA	FXAQ-P	FXLQ-MA FXNQ-MA	FXVQ-N
1	Remote controller	Wireless	BRC4C66		BRC4C64	BRC7CB59	BRC7EA66	BRC7EA619	BRC4C64	—
		Wired	BRC1C62						BRC1C62 Note 8	
2	Navigation remote controller (Wired remote controller)		BRC1E62 Note 7							
3	Simplified remote controller (Exposed type)		BRC2C51		BRC2C51	—			BRC2C51	—
4	Remote controller for hotel use (Concealed type)		BRC3A61		BRC3A61	—			BRC3A61	—
5	Adaptor for wiring		★KRP1C64	KRP1B61	—	KRP1BA54	—	KRP1B61	KRP1C67	
6-1	Wiring adaptor for electrical appendices (1)		★KRP2A61	KRP2A61	—	★KRP2A62	★KRP2A61	KRP2A61	KRP2A62	
6-2	Wiring adaptor for electrical appendices (2)		★KRP4AA51	KRP4AA51	★KRP4AA53	★KRP4AA52	★KRP4AA51	KRP4AA51	—	
7	Remote sensor (for indoor temperature)		KRCS01-4B	KRCS01-1B	KRCS01-4B	KRCS01-1B				
8	Installation box for adaptor PCB☆		Notes 2, 3 KRP4A98	Notes 2, 3 KRP4A96	—	KRP1BA97	Note 3 KRP1CA93	Note 1 KRP4AA93	—	
9	External control adaptor for outdoor unit		★DTA104A61	DTA104A61	—	★DTA104A62	★DTA104A61	DTA104A61	Note 10 DTA104A62	
10	Adaptor for multi tenant		★DTA114A61	—						—
11	External control adaptor for cooling/heating		—						KRP6A1 Note 10	
12	Remote controller with key		—						KRCB37-1	

- Notes: 1. Installation box ☆ is necessary for each adaptor marked ★.
 2. Up to 2 adaptors can be fixed for each installation box.
 3. Only one installation box can be installed for each indoor unit.
 4. Up to 2 installation boxes can be installed for each indoor unit.
 5. Installation box ☆ is necessary for second adaptor.
 6. Installation box ☆ is necessary for each adaptor.
 7. Individual airflow direction, auto airflow rate and sensing sensor control can be set only via wired remote controller BRC1E62. Cannot be set via other remote controllers. Available functions depend on the type of indoor unit.
 8. Since the control panel is equipped as standard, use the option for 2 remote control system.
 9. When using BRC1E62, be sure to remove the control panel and since BRC1E62 cannot be stored inside the indoor unit, please place it separately.
 10. Remove the group control adaptor which is a standard equipment before mounting KRP6A1 and DTA104A62.
 KRP6A1 and DTA104A62 cannot be mounted to the same indoor unit at the same time.

For residential indoor unit use

No.	Item	Type	Model No.		
			FDKS-EA, C(A)	FTKJ-N	FTKS-D,B,F
1	Remote controller	Wireless type	— Note 1		
2	Wiring adaptor for time clock/remote controller (Normal open pulse contact/normal open contact)		KRP413AB1S		
3	Remote controller loss prevention chain		KKF917A4	KKF910A4	KKF917A4
4	Interface adaptor for DIII-NET use		KRP928BB2S		

- Notes: 1. A wireless remote controller is a standard accessory.
 2. Time clock and other devices should be obtained locally.

System Configuration

No.	Item	Type	Model No.	Function
1	Residential central remote controller		Note 2 DCS303A51	• Up to 16 groups of indoor units (128 units) can be easily controlled using the large LCD panel. ON/OFF, temperature settings and scheduling can be controlled individually for indoor units.
2	5-room centralised controller for residential indoor units	For FDKS, FTKJ, FTKS	Note 3 KRC72A	• Up to 5 indoor units can be controlled. This is a low cost system which can only control ON/OFF.
3	Interface adaptor for residential indoor units		KRP928BB2S	• Adaptors required to connect products other than those of the VRV System to the high-speed DIII-NET communication system adopted for the VRV System.
4	Interface adaptor for SkyAir-series		Note 4 ★DTA112BA51	* To use any of the above optional controllers, an appropriate adaptor must be installed on the product unit to be controlled.
5	Central control adaptor kit For UAT(Y)-K(A),FD-K		★DTA107A55	
6	Wiring adaptor for other air-conditioner		★DTA103A51	
7	DIII-NET Expander Adaptor		DTA109A51	• Up to 1024 units can be centrally controlled in 64 different groups. • Wiring restrictions (max. length: 1,000m, total wiring length: 2,000m, max. number of branches: 16) apply to each adaptor.
7-1	Mounting plate		KRP4A92	• Fixing plate for DTA109A51

- Note: 1. Installation box for ★ adaptor must be obtained locally.
 2. For residential use only. Cannot be used with other centralised control equipment.
 3. A wiring adaptor (KRP413AB1S) is also required for each indoor unit.
 4. No adaptor is required for some indoor units.

Building Management System

No.	Item	Type	Model No.	Function		
1	intelligent Touch Controller	Basic	Hardware	intelligent Touch Controller	DCS601C51	• Air-Conditioning management system that can be controlled by a compact all-in-one unit.
1-1		Option	Hardware	DIII-NET plus adaptor	DCS601A52	• Additional 64 groups (10 outside units) is possible.
1-2	Electrical box with earth terminal (4 blocks)				KJB411A	• Wall embedded switch box.
2		Basic	Hardware	intelligent Touch Manager	DCM601A51	• Air-conditioning management system that can be controlled by touch screen.
2-1			Hardware	iTM plus adaptor	DCM601A52	• Additional 64 groups (10 outside units) is possible. Max. 7 iTM plus adaptors can be connected to intelligent Touch Manager.
2-2				iTM power proportional distribution	DCM002A51	• Power consumption of indoor units are calculated based on operation status of the indoor unit and outside unit power consumption measured by kWh metre.
2-3		Option	Software	iTM energy navigator	DCM008A51	• Building energy consumption is visualised. Wasted air-conditioning energy can be found out.
2-4				BACnet client	DCM009A51	• BACnet equipment can be managed by intelligent Touch Manager.
2-5				HTTP Interface	DCM007A51	• Interface for intelligent Touch Manager by HTTP
2-6			Hardware	*1 SVM series	SVMMPR2	• VRV Smart phone Control System for residence
2-7					SVMPS1	• Tenant Billing System with PPD
2-8	Di unit				DEC101A51	• 8 pairs based on a pair of ON/OFF input and abnormality input.
2-9	Dio unit				DEC102A51	• 4 pairs based on a pair of ON/OFF input and abnormality input.
3				*2 Interface for use in BACnet®	DMS502B51	• Interface unit to allow communications between VRV and BMS. Operation and monitoring of air-conditioning systems through BACnet® communication.
3-1				Optional DIII board	DAM411B51	• Expansion kit, installed on DMS502B51, to provide 2 more DIII-NET communication ports. Not usable independently.
3-2				Optional Di board	DAM412B51	• Expansion kit, installed on DMS502B51, to provide 16 more wattmeter pulse input points. Not usable independently.
4				*3 Interface for use in LONWORKS®	DMS504B51	• Interface unit to allow communications between VRV and BMS. Operation and monitoring of air-conditioning systems through LonWorks® communication.
5	Contact/ analogue signal			Unification adaptor for computerised control	★DCS302A52	• Interface between the central monitoring board and central control units.

- Notes: *1. HTTP interface (DCM007A51) is also required.
 *2. BACnet® is a registered trademark of American Society of Heating, Refrigerating and Air-Conditioning Engineers (ASHRAE).
 *3. LonWorks® is a trademark of Echelon Corporation registered in the United States and other countries.
 *4. Installation box for ★ adaptor must be obtained locally.

Individual Control Systems for VRV Indoor Units

Navigation remote controller (Wired remote controller) (Option)



BRC1E62

Clear display

•Dot matrix display

- A combination of fine dots enables various icons. Large text display is easy to see.



•Backlight display

- Backlight display helps operating in dark rooms.

Simple operation

•Large buttons and arrow keys

- Large buttons and arrow keys enable easy operation. Basic setting such as fan speed and temperature can be intuitively operated. For other settings just select the function from the menu list.

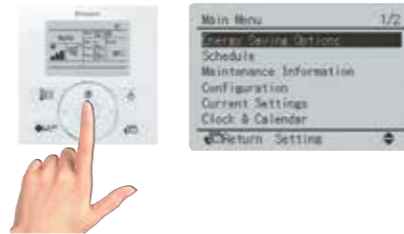

•Guide on display

- The display gives an explanation of each setting for easy operation.

Energy saving

•Setpoint range set

- Saves energy by limiting the min. and max. set temperature.
- Avoids excessive cooling.
- This function is convenient when the remote controller is installed at a place where any number of people may operate it.



•Setpoint auto reset

- Even if the set temperature is changed, it returns to the preset temperature after a preset period of time.
- Period selectable from 30 min/60 min/90 min/120 min.



Restaurant sample

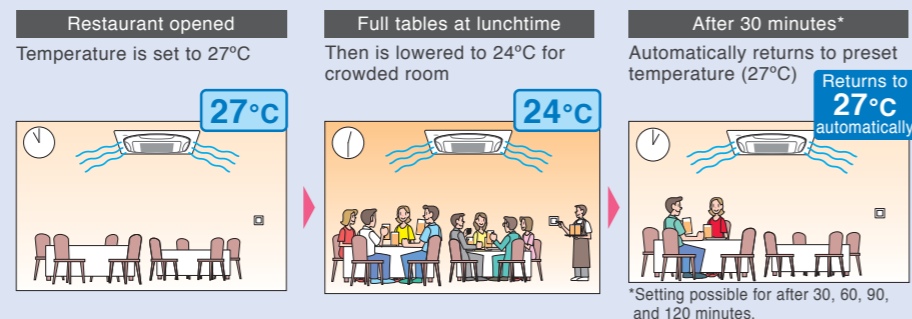

•Off timer

- Turns off the air conditioner after a preset period of time.
- Period can be preset from 30 to 180 minutes in 10-minute increments.

Convenience

•Setback (default:OFF)

- Maintains the room temperature in a specific range during unoccupied period by temporarily starting air conditioner that was turned OFF.

Ex) Setback temperature Cooling : 35°C Recovery differential Cooling : -2°C
When the room temperature goes above 35°C, the air conditioner starts operating in Cooling automatically. When room temperature reaches 33°C, the air conditioner returns OFF.

	Setback temperature	Recovery differential
Cooling	33 — 37°C	-2 — -8°C

•Weekly schedule

- 5 actions per day can be scheduled for each day of the week.
- The holiday function will disable schedule timer for the days that have been set as holiday.
- 3 independent schedules can be set. (e.g. summer, winter, mid-season)

Time	Act	Cool	Heat
Mon: 8:30	ON	25°C	—
10:00	OFF	—	—
13:00	ON	25°C	—
15:00	OFF	—	—

College classroom sample (a summer Monday case)

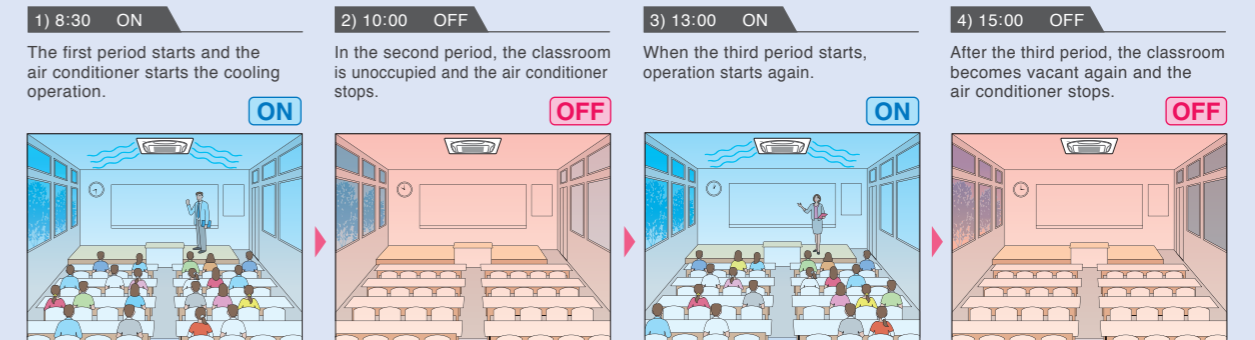

Comfort

•Individual airflow direction (*1)

- Airflow direction of each of the four air outlets can be controlled individually. (Positions 0 to 4, Swing, and No individual setting are selectable.)

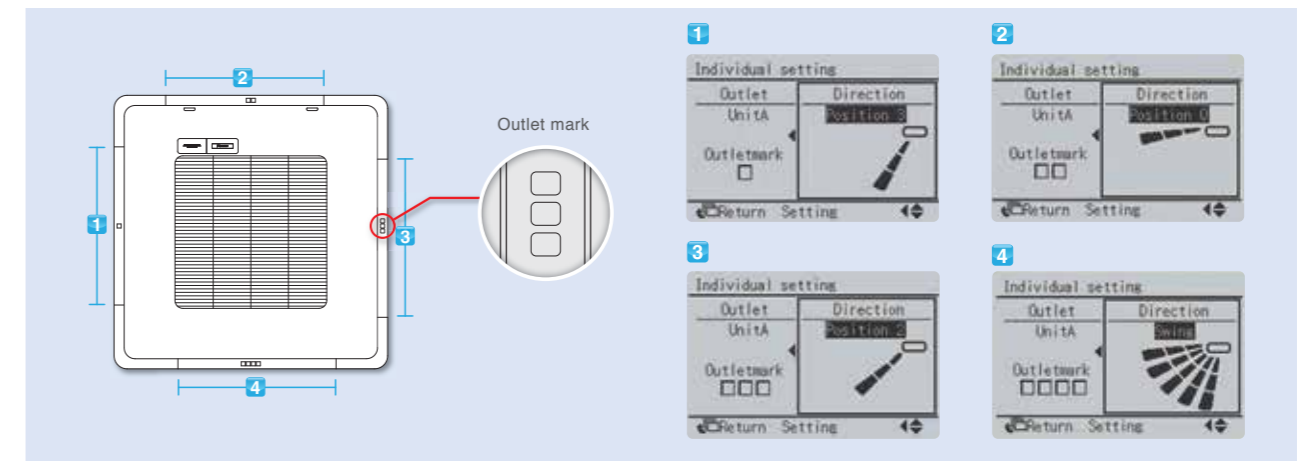

•Auto airflow rate (*2)

- Airflow rate is automatically controlled in accordance with the difference between room temperature and set temperature.

*1 Only available for VRV 4-Way Flow Ceiling Suspended type FXUQ-A series and Ceiling Mounted Cassette (Round Flow with Sensing) type FXFQ-S series.
*2 Only available for VRV 4-Way Flow Ceiling Suspended type FXUQ-A series, Ceiling Mounted Cassette (Round Flow with Sensing) type FXFQ-S series and Middle Static Pressure Ceiling Mounted Duct type FXSQ-P series.

Individual Control Systems for VRV Indoor Units

Wired remote controller (Option)



BRC1C62

- Displays current airflow, swing, temperature, operating mode and timer settings.

* Individual airflow direction, auto airflow rate and sensing sensor control can be set only via wired remote controller BRC1E62. Cannot be set via other remote controllers.

Wireless remote controller (Option)



Wireless remote controller

Signal receiver unit (Separate type)

- The same operation modes and settings as with wired remote controllers are possible.
- * Individual airflow direction, auto airflow rate and sensing sensor control can be set only via wired remote controller BRC1E62. Cannot be set via other remote controllers.
- A compact signal receiver unit (separate type) to be mounted into a wall or ceiling is included.
- A signal receiver unit (installed type) for a Ceiling Mounted Cassette (Round Flow, Compact Multi Flow, Double Flow) type, Ceiling Suspended type and Wall Mounted type is mounted into the indoor unit.



Signal receiver unit can be installed on the panel
ex. Ceiling Mounted Cassette (Round Flow) type

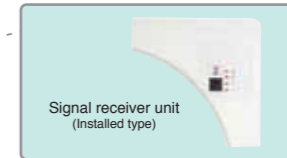

Signal receiver unit (Installed type)

* Wireless remote controller and signal receiver unit are sold as a set.
* Refer to page 63 for the name of each model.

Simplified remote controller (Option)



Exposed type (BRC2C51)

Concealed type (For hotel use) (BRC3A61)

- The remote controller has centralised its frequently used operation selectors and switches (on/off, operation mode, temperature setting and airflow volume), making itself suitable for use in hotel rooms or conference rooms.
- The exposed type remote controller is fitted with a thermostat sensor.



The concealed type remote controller smartly fits into a night table or console panel in a hotel room.

The wired remote controller supports a wide range of control functions

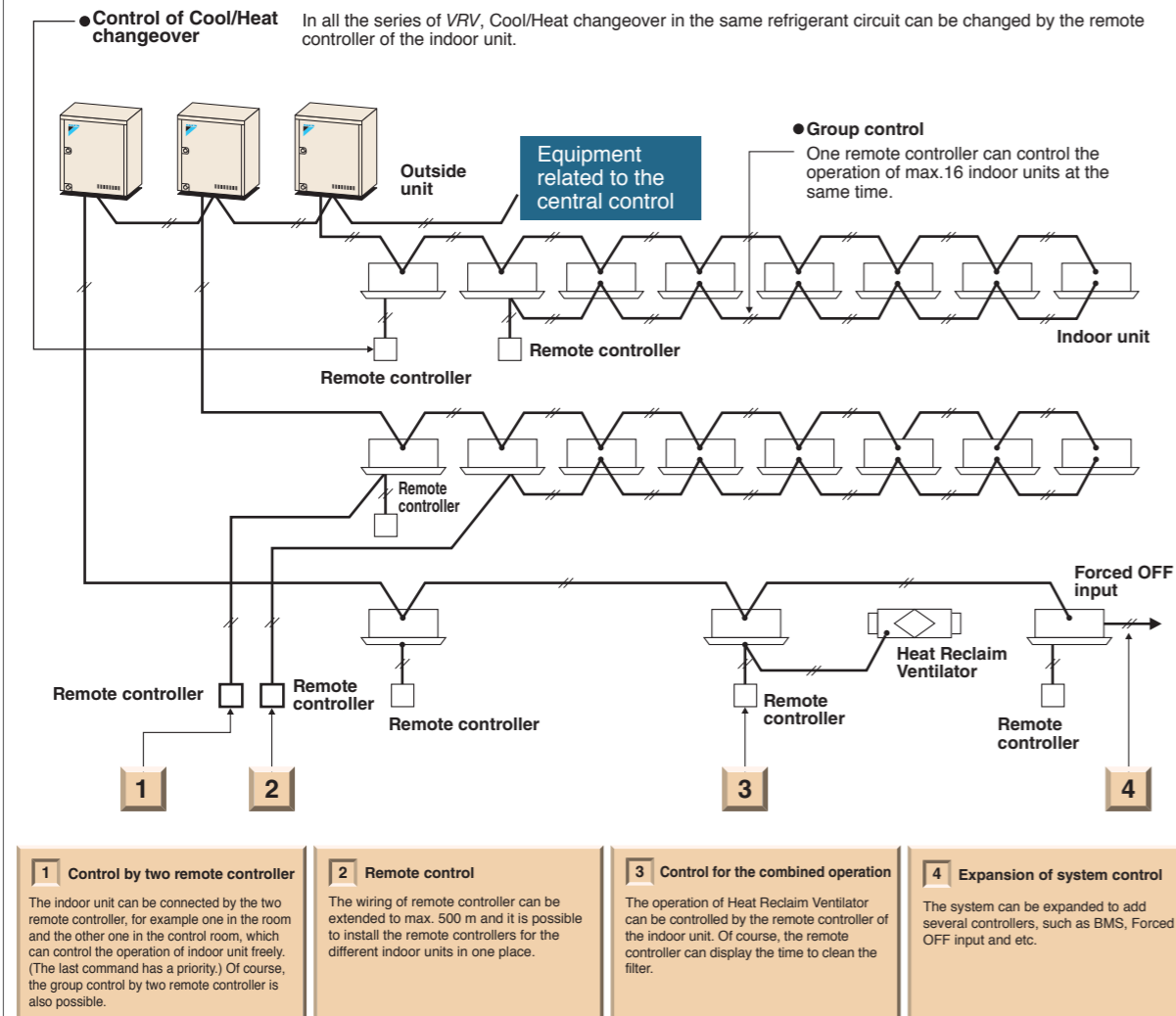

Wide variation of remote controllers for indoor units

	FXFQ-S	FXFQ-LU	FXZQ	FXCQ	FXKQ	FXDQ-PB/NB	FXDQ-SP	FXSQ	FXMQ	FXUQ	FXHQ	FXAQ	FXL(N)Q	FXVQ
Navigation remote controller (Wired remote controller) (BRC1E62)	●	●	●	●	●	●	●	●	●	●	●	●	●	●
Wired remote controller (BRC1C62)	●	●	●	●	●	●	●	●	●	●	●	●	●	●
Wireless remote controller* (Installed type signal receiver unit)	●	●	●	●						●	●	●		
Wireless remote controller* (Separate type signal receiver unit)					●	●	●	●	●				●	
Simplified remote controller (Exposed type) (BRC2C51)						●	●	●	●				●	
Simplified remote controller (Concealed type: for Hotel use) (BRC3A61)						●	●	●	●				●	

*Refer to page 63 for the name of each model.

Integrated Building Monitoring System

The high speed transmission of DIII-NET enables more advanced control of the VRV system, providing you with enhanced comfort.

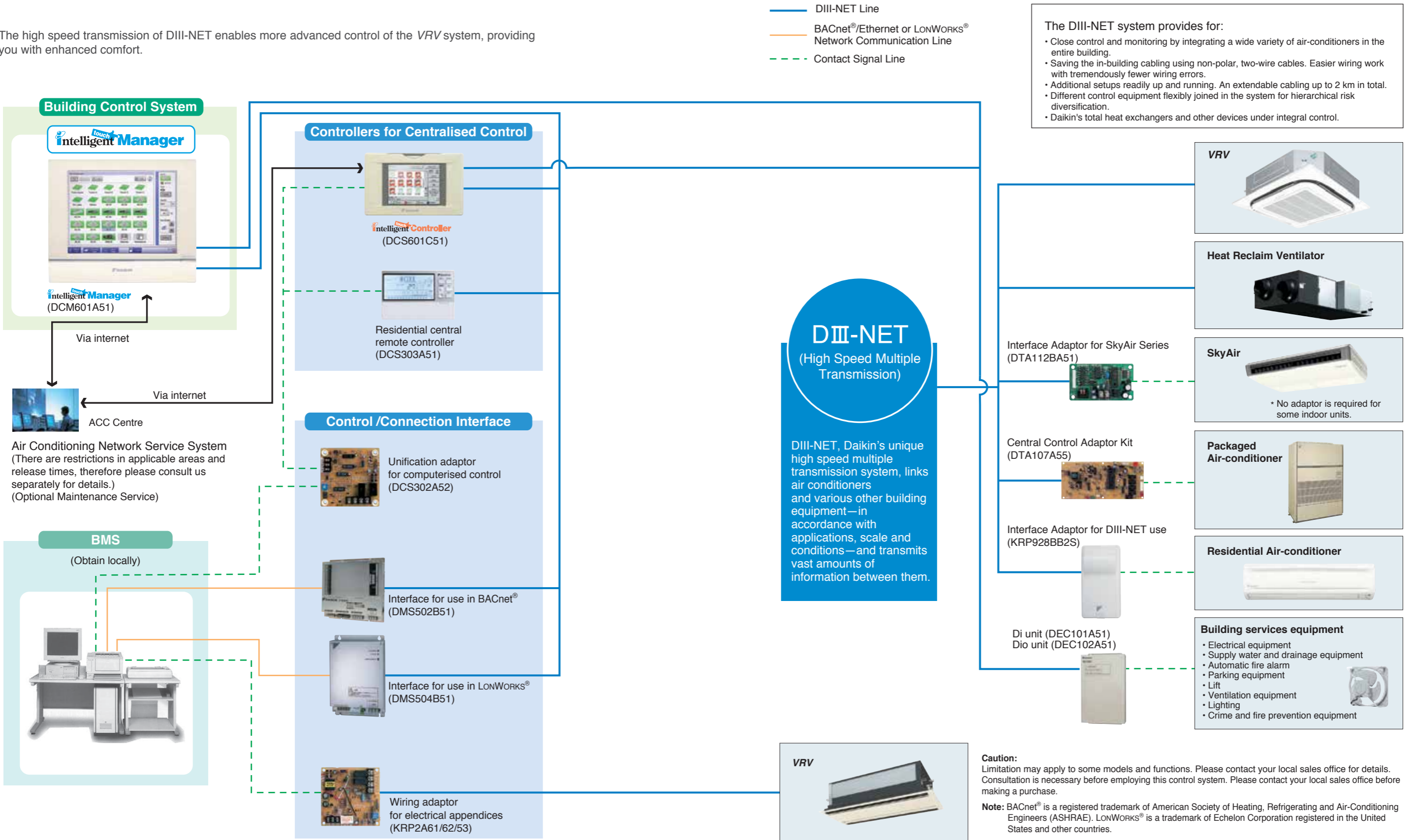

Advanced Control Systems for VRV Indoor Units



One touch selection enables flexible control of equipment in a building.



DCM009A51

Various types of equipment in a building can be controlled by a single controller.

Individual air-conditioning control

The flexible control achieved by the VRV system precisely meets different air conditioning needs in each room (e.g. offices, conference rooms, hotel rooms).



Lighting control DALI-compatible

DALI-compatible LED lighting systems can be controlled and monitored. Lighting control is enhanced through an interlock function with air conditioners and other functions.

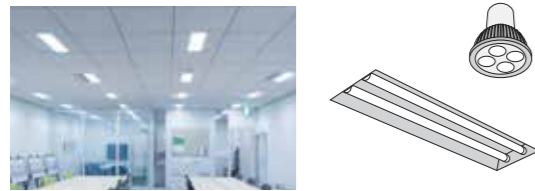

Air-conditioning control for large spaces

Air handling units can also be controlled. Large spaces, such as entrance halls and shopping malls, can be easily controlled to ensure comfort.

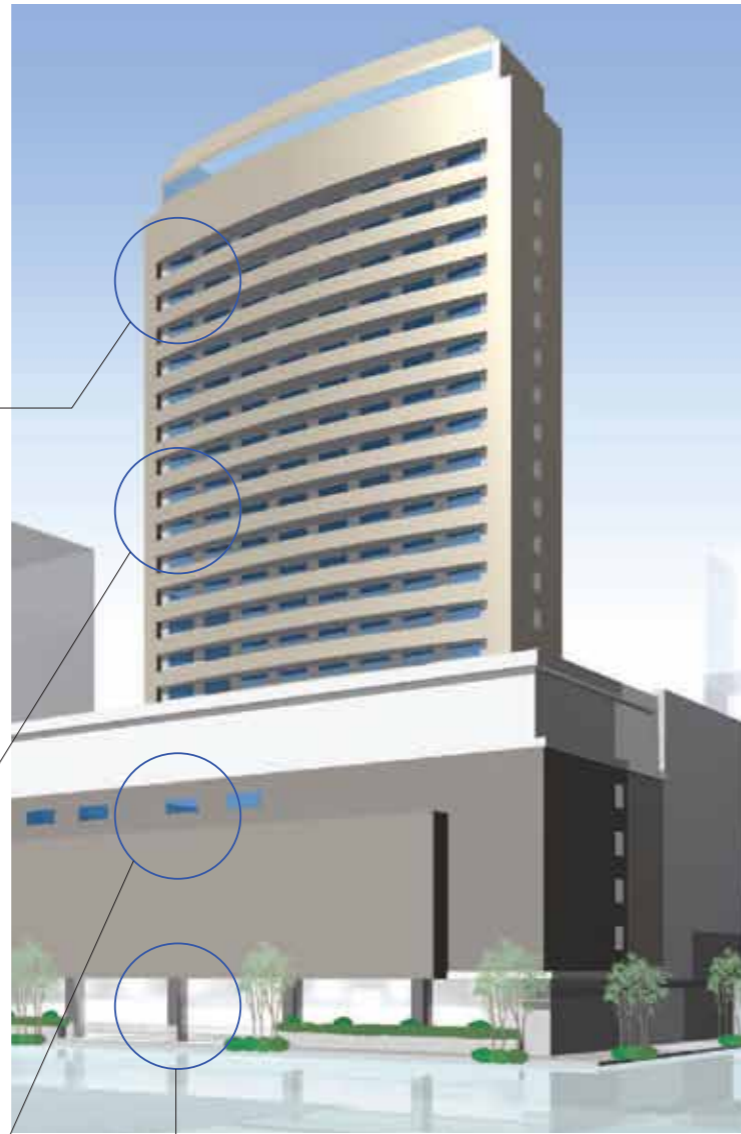

Building equipment control

Various types of equipment other than air conditioners, including ventilators, fans, and pumps, can also be controlled.

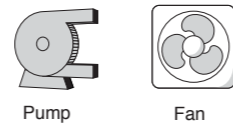

For Energy Saving & Comfort

Intelligent Touch Manager maximises the advantages of VRV features

Intelligent Touch Manager is an advanced multi-zone controller that provides the most cost-effective way to control and monitor the Daikin VRV system.

The 10.4" LCD touch screen is easy to use with three different screen views to include the floor plan layout view, icon view and list view and menus for system configurations.

It is also easy to use with standardized remote Web Access from your PC.

It can manage a total of 650 management points consisting of up to 512 Daikin indoor unit groups (up to 1024 indoor units) along with building equipment control / monitoring with Digital Inputs / Output (Di/Dio), Analog Inputs / Output (Ai/Ao) and Pulse input (Pi) optional devices.

Schedule the operation time for each application.	Define the setpoint range that users can change.
	<p>With Remote controller</p> <p>With Control System</p>
<p>Turn the unit OFF if a user didn't.</p>	<p>Reset setpoint regularly.</p>

Advanced Control Systems for VRV Indoor Units

In addition to switching lights on and off, advanced lighting control, such as illuminance adjustment, can be achieved

Lighting control (Option)

Connection to DALI - compatible lighting control system

Simple wiring (daisy chain) enables management of LED lighting by the *intelligent Touch Manager*.

Various air conditioning and lighting control is enabled through the interlock with occupancy sensors and illuminance sensors.

DALI-compatible

Please contact your local sales office for details.

Lighting control achieved by the *intelligent Touch Manager*

- [Operation]
- Switch-on/switch-off operation
 - Illuminance (1-100%) control
 - Various illuminance patterns can be registered
 - Registered pattern can be selected from *intelligent Touch Manager*

- [Monitoring]
- Switch-on/switch-off status monitoring
 - Lighting abnormality monitoring
 - Illuminance monitoring
 - DALI occupancy sensor monitoring
 - DALI illuminance sensor monitoring

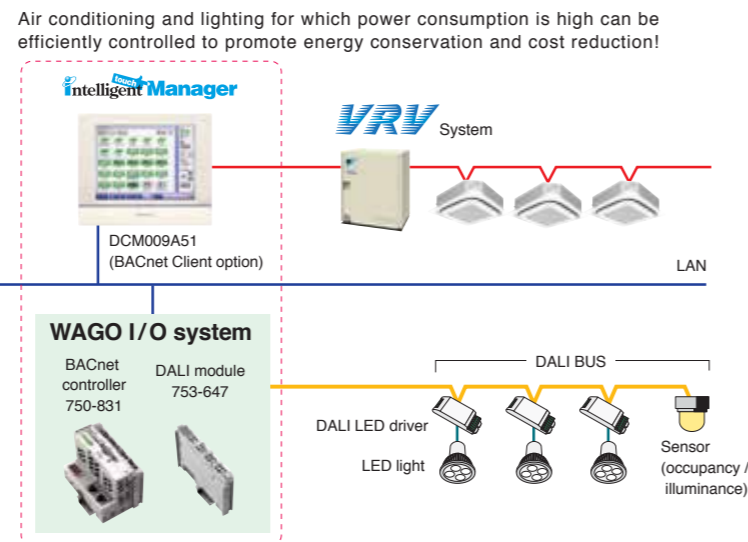

Air conditioning and lighting for which power consumption is high can be efficiently controlled to promote energy conservation and cost reduction!

[Overview of control]

- Up to 5 DALI modules can be connected to a single BACnet controller.
- Up to 64 DALI LED drivers (64 addresses) can be connected to a single DALI module.
- 64 DALI addresses can be freely assigned to up to 16 groups using a single DALI module. (Each group corresponds to a management point of the *intelligent Touch Manager*.)
- Up to 16 scenes can be set to a single DALI module.
- Up to 12 sensors (occupancy, illuminance) can be connected to a single DALI module.
- DALI BAS simplifies wiring and setting work by daisy chain wiring and automatic address setting.

Easy maintenance and energy saving by lighting control

Case1

Switch-on / switch-off and illuminance are controlled based on a schedule to cut wasteful power consumption.

- Failing to switch off lights is prevented.



• Optimal illuminance reduces energy.

Case2

Occupancy sensors are used to eliminate both wasteful lighting and air conditioning. When a room is unoccupied, the air conditioning stops and the lighting is switched off.

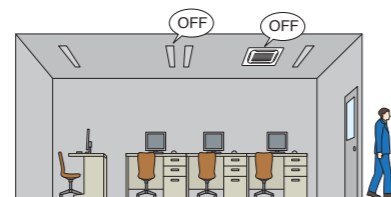

Case3

Lighting abnormalities (e.g. burned-out bulbs) can be checked on the *intelligent Touch Manager* screen. Lighting maintenance becomes easier and quicker.

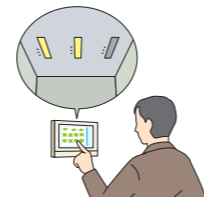

The layout screen enables quick identification of specific locations.

Tenant Management (PPD*Option) Reporting the power consumption of VRV system for each tenant

With the PPD function, power consumption can be calculated for each indoor unit (Option)

The energy consumption is proportionally calculated for each indoor unit. The data can be used for energy management and calculation of air conditioning usage fees for respective tenants.

Operational information of individual indoor units are monitored, based on distribution of power consumption of outdoor units.

Daikin's PPD keeps track of power distribution for each indoor unit. It performs air conditioning billing calculations quickly and automatically.

It is easy to output PPD data.

PPD data is output in CSV format to a PC or USB memory device and can be freely processed and managed.

*PPD (Power Proportional Distribution) is Daikin's proprietary calculation method.

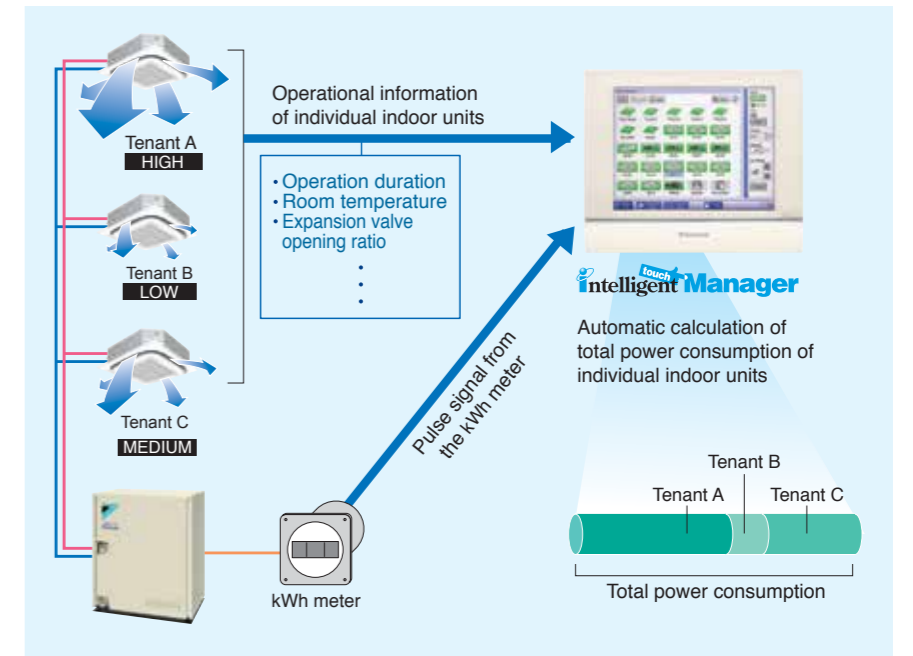

Air conditioning bills can be issued by one click

Electricity bills can be easily calculated for each tenant (Option)

The power consumption of VRV controlled by the *intelligent Touch Manager* can be easily managed for each tenant using a PC. The electricity bill settings facilitate billing work through easy calculation and issuance of VRV electricity bills.

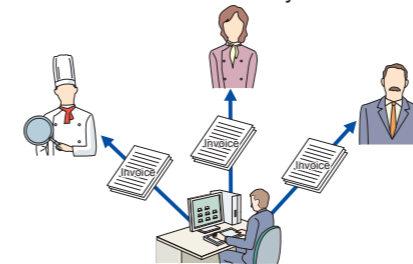

[Main functions]

- Register tenants
- Set the electricity unit price for 5 time zones
- Calculate power consumption and electricity charge for each tenant
- Show aggregation results in the specified period for each tenant
- Output the results (Printout and CSV file)

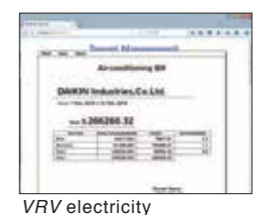
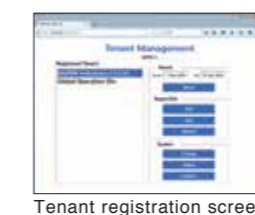
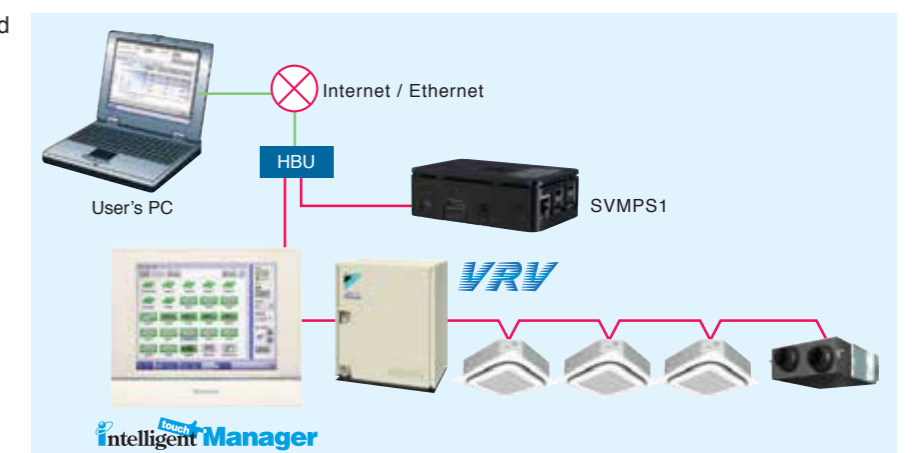

Advanced Control Systems for VRV Indoor Units

System structure

intelligent Touch Manager System Overview

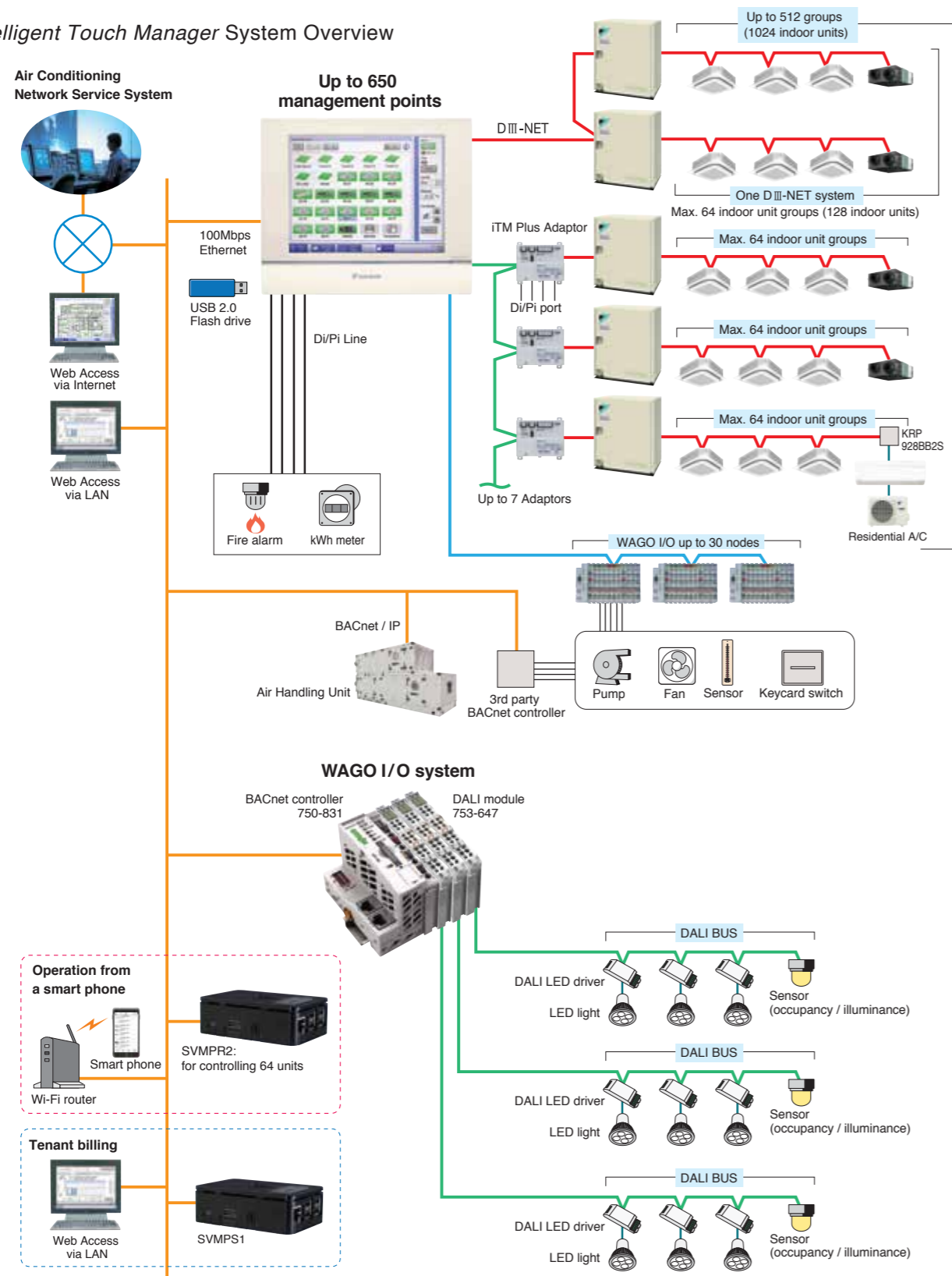

Air Conditioning Network Service System

Preventive Maintenance

The *intelligent Touch Manager* can be connected to Daikin's own Air Conditioning Network Service System for remote monitoring and verification of operation status for VRV system. By its ability to predict malfunctions, this service provides customers with additional peace of mind.

Enhanced convenience with link to the Air Conditioning Network Service System

The *intelligent Touch Manager* connects seamlessly to Daikin's 24-hour Air Conditioning Network Service System.

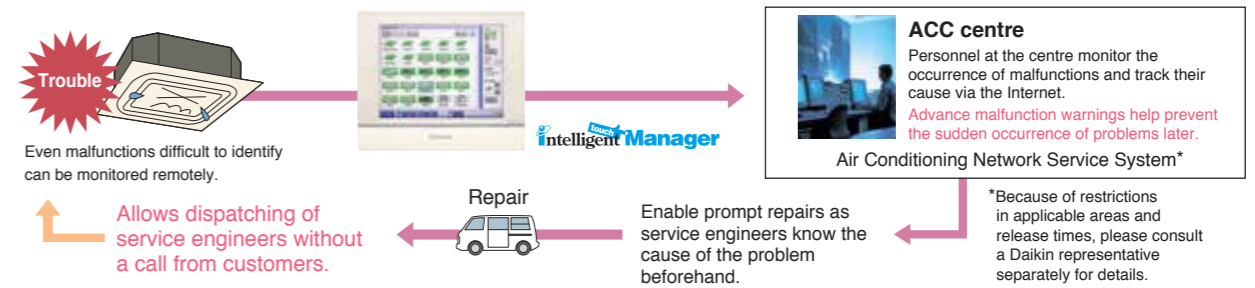

Daikin Offers a Variety of Control Systems

Convenient controllers that offer more freedom to administrators



DCS601C51

intelligent Touch Controller

Ease of use and expanded control functions

The user-friendly controller features colours, multilingual function, and icons in the display for ease of understanding. A wide variety of control methods can be accommodated, permitting administrators to monitor and operate the system even when they are away from the controller.

Connect VRV system to your BMS via BACnet® or LonWORKS®

Compatible with BACnet® and LonWORKS®, the two leading open network communication protocols, Daikin offers interfaces that provide a seamless connection between VRV system and your BMS.

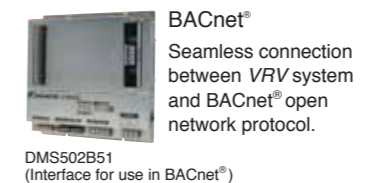

DMS502B51 (Interface for use in BACnet®)

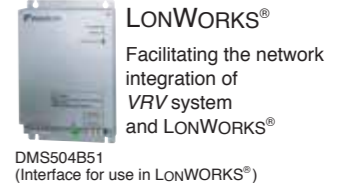

DMS504B51 (Interface for use in LonWORKS®)

Dedicated interfaces make Daikin air conditioners freely compatible with open networks

Notes: 1. BACnet® is a registered trademark of American Society of Heating, Refrigerating and Air-Conditioning Engineers (ASHRAE).
2. LonWORKS® is a trademark of Echelon Corporation registered in the United States and other countries.

Smart phone will be a remote controller of VRV system (Option)

For house VRV Smart phone Control System

Up to 64 indoor units can be controlled.

Just add SVMPR1 to this system

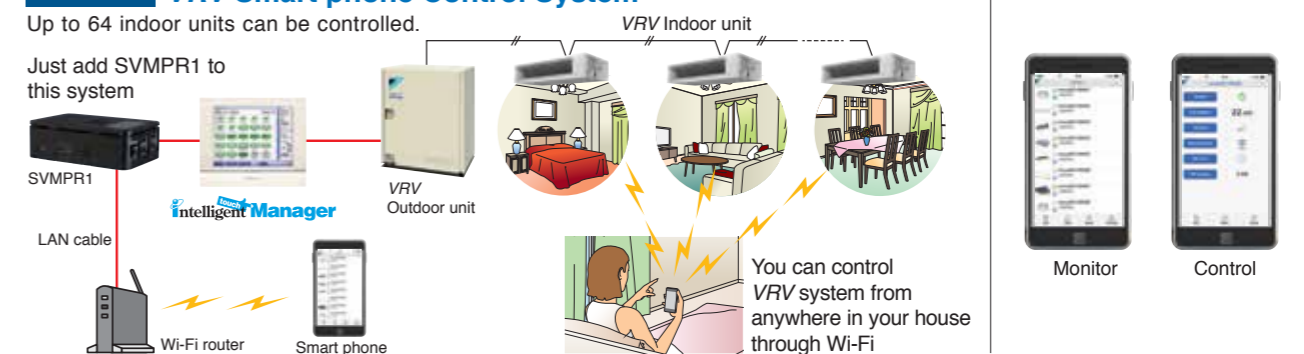

Daikin's air treatment systems creating a higher air quality environment

Components of Indoor Air Quality

Ventilation Humidification
Air Processing*

*Refers to bringing outdoor air to near indoor temperature and delivering to a room.

A recent trend rapidly gaining popularity is for air treatment to be required as well as air conditioning. Daikin's Outdoor-Air Processing Unit can combine fresh air treatment and air conditioning, supplied from a single system. It adjusts the temperature of air from outdoors using a fixed discharge temperature control. Along with Outdoor-Air Processing Units, we also offer Heat Reclaim Ventilator systems. The Heat Reclaim Ventilator VAM-GJ series units in particular have been praised for their compactness, energy conservation and extensive operation range of outdoor temperatures. This series provides higher enthalpy efficiency^{★1}, due to the greatly enhanced performance of the thin film element. Furthermore, improved external static pressure^{★2} offers more flexibility for installation. The Heat Reclaim Ventilator VKM-GAM series units, equipped with a DX-coil and a humidifier, provide further advanced features, such as temperature adjustment to suit conditions indoors and to prevent cold air from blowing on people directly during heating operation. The series also realises significant energy savings by exercising heat recovery.

★1 For models: VAM150/250/350/650/800/1000/2000GJVE
★2 For models: VAM150/350/500GJVE

	Outdoor-Air Processing Unit	Heat Reclaim Ventilator			
		VKM-GAM Type	VKM-GA Type	VAM-GJ Type	
Connections with VRV/IV W series	Refrigerant Piping	Connectable	Connectable	Not connectable	
	Wiring	Connectable	Connectable	Connectable	
	After-cool & After-heat Control	Available	Available	Not available	
Heat Exchange Element	—	Energy savings obtained		Energy savings obtained	
Humidifier	—	Fitted	—	—	
High Efficiency Filter	Option	Option		Option	
Ventilation System	Air supply only	Air supply & air exhaust		Air supply & air exhaust	
Power Supply	220-240 V, 50 Hz	220-240 V, 50 Hz		220-240 V/220 V, 50 Hz/60 Hz	
Airflow Rate				150 m ³ /h	
				250 m ³ /h	
				350 m ³ /h	
			500 m ³ /h		500 m ³ /h
					650 m ³ /h
			800 m ³ /h		800 m ³ /h
		1080 m ³ /h	1000 m ³ /h		1000 m ³ /h
		1680 m ³ /h			1500 m ³ /h
	2100 m ³ /h			2000 m ³ /h	

*Refers to bringing outdoor air to near indoor temperature and delivering to a room.

Outdoor-Air Processing Unit

Combine fresh air treatment and air conditioning, supplied from a single system.

Lineup

Model Name	FXMQ125MFV1	FXMQ200MFV1	FXMQ250MFV1
Capacity Index	125	200	250



Fresh air treatment and air conditioning can be achieved with a single system by using heat pump technology—without the usual troublesome air supply and air discharge balance design. Fan coil units for air conditioning and an outdoor-air processing unit can be connected to the same refrigerant line. The results are enhanced design flexibility and a significant reduction in total system costs.

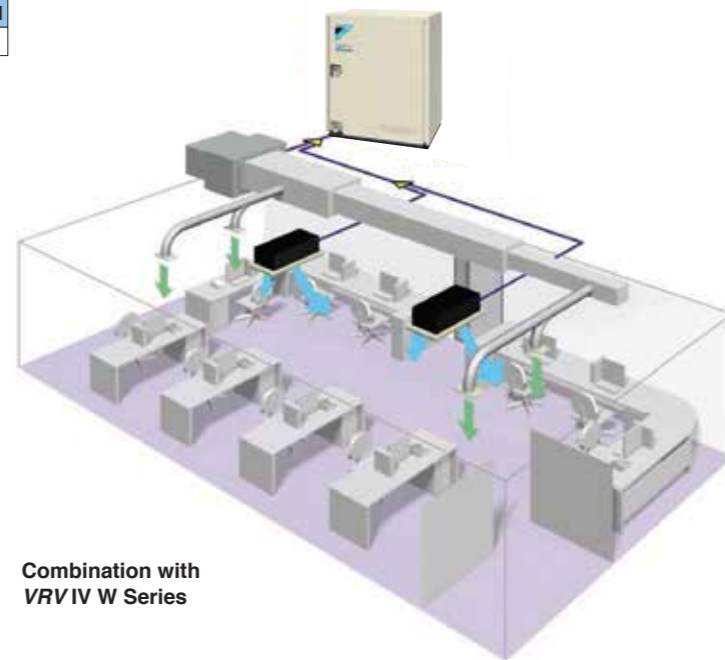

Combination with VRV IV W Series

Air conditioning and outdoor air processing can be accomplished using a single system.

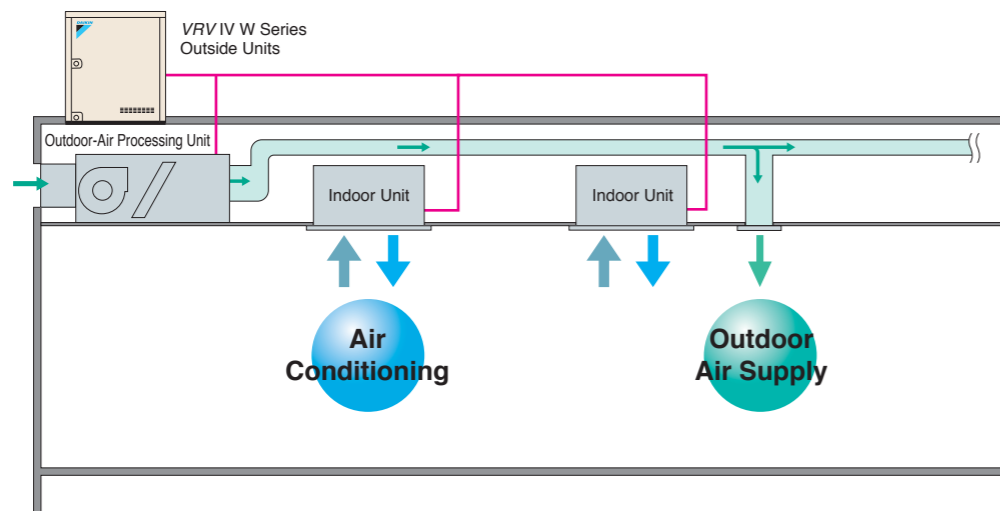

Connection Conditions

The following restrictions must be observed in order to maintain the indoor units connected to the same system.

- When outdoor-air processing units are connected, the total connection capacity index must be 50% to 100% of the capacity index of the outside units.
- When outdoor-air processing units and standard indoor units are connected, the total connection capacity index of the outdoor-air processing units must not exceed 30% of the capacity index of the outside units.
- Outdoor-air processing units can be used without indoor units.

- The unit introduces outdoor air and adjusts the outdoor air temperature via fixed discharge temperature control, thereby reducing the air conditioning load.
- The system can operate with outdoor-air temperatures ranging from -5 to 43°C. Heating performance is somewhat adversely affected when the outdoor-air temperature is 0°C or below.
- When shipped from the factory, the thermostat is set at 18°C for cooling and 25°C for heating. The set temperature can be varied within the range of 13–25°C during cooling operation, and 18–30°C during heating operation, in the local setting mode using the wired remote controller. The temperature, however, is not displayed on the remote controller.
- While in machine protection mode and depending on outdoor air conditions, discharge air temperature may not be at the set temperature.
- The fan stops when operating in defrosting, oil returning and hot start operations. The fan also may stop due to mechanical protection control.
- Ceiling mounted duct units with three differing capacities are available. These can be connected to VRV series outdoor units to meet a variety of different requirements.

Airflow rate

FXMQ125MFV1	1,080 m ³ /h
FXMQ200MFV1	1,680 m ³ /h
FXMQ250MFV1	2,100 m ³ /h

- Optional equipment includes long-life filters.
- Compatible with outdoor temperatures from -5°C to 43°C.

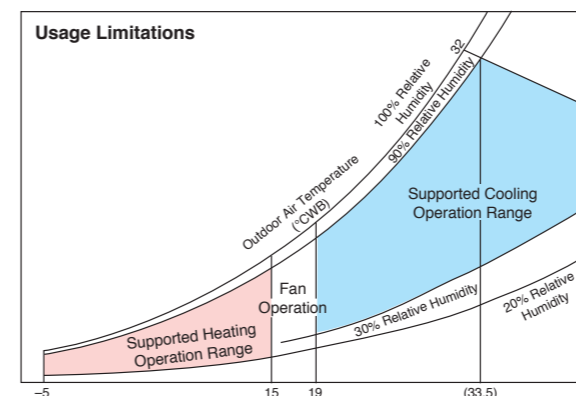

Notes:

1. The data shown in the graph illustrates the supported operation ranges under the following conditions.
Indoor and Outdoor Unit
Effective piping length: 7.5 m
Height differential: 0 m
2. The discharge temperature can be set using the remote controller. However, the actual temperature may not match the temperature setting under some circumstances due to the outdoor-air processing load or mechanical protection controls.
3. The system will not operate in fan mode when the outdoor air temperature is 5°C or below.

- High-performance filters with dust collection efficiencies (JIS calorimetry) of 90% and 65% are also available as options.

- As with the VRV IV system, a variety of control systems can be deployed, including remote control from distances of up to 500 m.



BRC1E62
Navigation remote controller
(Wired remote controller)
(option)

- Group control is not possible between this unit and standard type indoor units. Connect remote controllers to each unit.

- The “self-diagnosis function” indicates the occurrence and nature of abnormalities in the system by displaying codes on the remote controller.

- A central control system compatible with the VRV IV system can be installed.



DCS302CA61
Central remote controller
(option)

- It is not possible to change the discharge air temperature settings from the central control system.
- Do not associate this equipment into zones with standard indoor units, as central control will not be possible.

- As with the VRV IV system, the equipment employs the “super wiring system” so that the wiring linking indoor and outdoor units can also be utilised for central control.

Notes:

- Linked control of the product and the Heat Reclaim Ventilator is not supported.
- This equipment is intended for the treatment of outdoor air only. It is not to be used for maintaining indoor air temperature. Install and use with standard indoor units. Be sure to position the air discharge openings of the product in positions where the airflow will not blow on people directly. When outdoor-air processing is in excess, the unit switches to thermo-off mode, and outdoor air flows into the room directly.
- For outdoor ducts, be sure to provide heat insulation to prevent condensation.
- Group control of the product and the standard indoor units is not supported. A separate remote controller should be connected to each individual unit.
- The system will not operate in fan mode when the outdoor air temperature is 5°C or below.
- If the product is allowed to operate 24 hours a day, maintenance (part replacement, etc.) must be performed periodically.
- Temperature setting and Power Proportional Distribution (PPD) are not possible even if the intelligent Touch Controller or the intelligent Touch Manager is installed.
- The remote controller wired to the outdoor-air processing unit must not be set as the master remote controller. Otherwise, when set to “Auto,” the operation mode will switch according to the outdoor air conditions, regardless of the indoor temperature.

Standard specifications

Indoor unit

Type		Ceiling Mounted Duct Type		
Model		FXMQ125MFV1	FXMQ200MFV1	FXMQ250MFV1
Power supply		1-phase 220-240 V (also required for indoor units), 50 Hz		
Cooling capacity *1	kcal/h	12,000	19,300	24,100
	Btu/h	47,800	76,400	95,500
	kW	14.0	22.4	28.0
Power consumption	kW	0.359	0.548	0.638
Casing		Galvanised steel plate		
Dimensions (HXWD)		470X744X1,100		470X1,380X1,100
Fan	Motor output	0.380		
	Airflow rate	m ³ /min	18	28
		cfm	635	988
External static pressure 220 V/240 V	Pa	185/225	225/275	205/255
Air filter		*2		
Refrigerant piping	Liquid	φ 9.5 (flare)		
	Gas	φ 15.9 (flare)	φ 19.1 (brazing)	φ 22.2 (brazing)
	Drain	PS1B female thread		
Machine weight	kg	86	123	
Sound level *3	220 V/240 V	42/43		47/48
Connectable outside units *4		6 HP and above	8 HP and above	10 HP and above
Operation range (Fan mode operation between 15 and 19°C)	Cooling	19 to 43°C		
Range of the discharge temperature *5	Cooling	13 to 25°C		

Notes: *1. Specifications are based on the following conditions:
 • Cooling: Outdoor temp. of 33°CDB, 28°CWB (68% RH), and discharge temp. of 18°CDB.
 • Equivalent reference piping length: 7.5 m (0 m horizontal)
 *2. An intake filter is not supplied, so be sure to install the optional long-life filter or high-efficiency filter. Please mount it in the duct system of the suction side. Select a dust collection efficiency (gravity method) of 50% or more.
 *3. Anechoic chamber conversion value, measured at a point 1.5 m downward from the unit centre. These values are normally somewhat higher during actual operation as a result of ambient conditions.
 *4. It is possible to connect to the outside unit if the total capacity of the indoor units is 50% to 100% of the capacity index of the outside units.
 *5. Local setting mode. Not displayed on the remote controller.
 * This equipment cannot be incorporated into the remote group control of the VRV IV W Series.

OPTIONS

Indoor unit

Model		FXMQ125MFV1	FXMQ200MFV1	FXMQ250MFV1
Operation/control	Operation remote controller	BRC1E62/BRC1C62		
	Central remote controller	DCS302CA61		
	Unified ON/OFF controller	DCS301BA61		
	Schedule timer	DST301BA61		
	Wiring adaptor for electrical appendices (1)	KRP2A61		
	Wiring adaptor for electrical appendices (2)	KRP4AA51		
Filters	Long-life replacement filter	KAFJ371L140	KAFJ371L280	
	High-efficiency filter	Colourimetric method 65%	KAFJ372L140	
		Colourimetric method 90%	KAFJ373L140	
	Filter chamber *1	KDJ3705L140	KDJ3705L280	
Drain pump kit		KDU30L250VE		
Adaptor for wiring		KRP1B61		

Notes: *1. Filter chamber has a suction-type flange. (Main unit does not.)
 • Dimensions and weight of the equipment may vary depending on the options used.
 • Some options may not be usable due to the equipment installation conditions, so please confirm prior to ordering.
 • Some options may not be used in combination.
 • Operating sound may increase somewhat depending on the options used.

Dimensions

FXMQ125/200/250MFV1

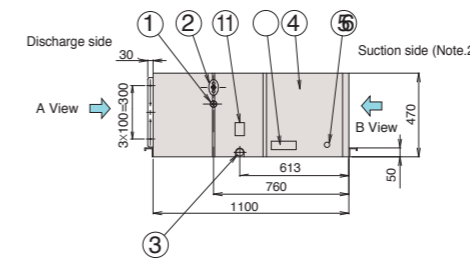
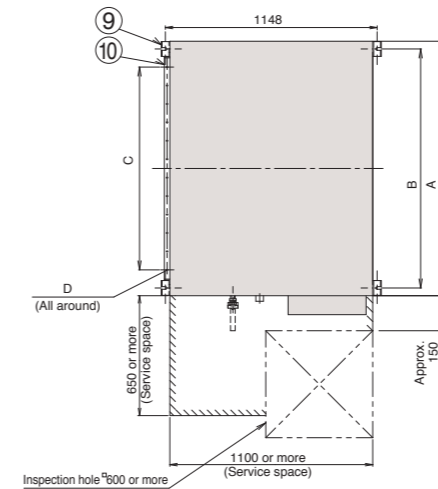

*These diagrams are based on FXMQ200 and FXMQ250MFV1.

Local connection piping size

Model	Gas piping diameter	Liquid piping diameter
FXMQ125MFV1	φ15.9	φ9.5
FXMQ200MFV1	φ19.1 attached piping	φ9.5
FXMQ250MFV1	φ22.2 attached piping	φ9.5

Table of dimensions

Model	A	B	C	D
FXMQ125MFV1	744	685	5X100=500	20-φ4.7 hole
FXMQ200MFV1	1380	1296	11X100=1100	32-φ4.7 hole
FXMQ250MFV1	1380	1296	11X100=1100	32-φ4.7 hole

Notes:

- The attached piping in the diagram is for FXMQ200MFV1 and FXMQ250MFV1 only. The gas piping connection port (② in the diagram) has a different bore form with FXMQ125MFV1.
- An air filter is not supplied with this unit. Be sure to mount an air filter in the suction side. [Use a filter with dust collection efficiency of at least 50% (gravimetric method). This is available as an option.]
- For outdoor ducts, be sure to provide heat insulation to prevent condensation.

- ① Liquid pipe connection
- ② Gas pipe connection
- ③ Drain piping connection
- ④ Electric parts box
- ⑤ Ground terminal
- ⑥ Name plate
- ⑦ Power supply wiring connection
- ⑧ Transmission wiring connection
- ⑨ Hanger bracket
- ⑩ Discharge companion flange
- ⑪ Water supply port
- ⑫ Attached piping (Note. 1)

FXMQ200/250MFV1

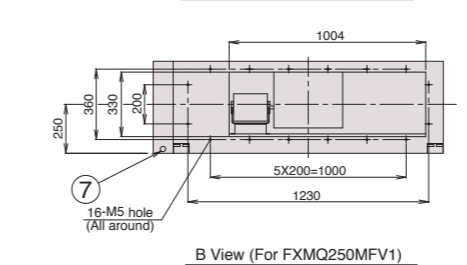
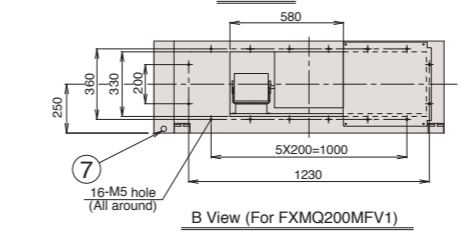
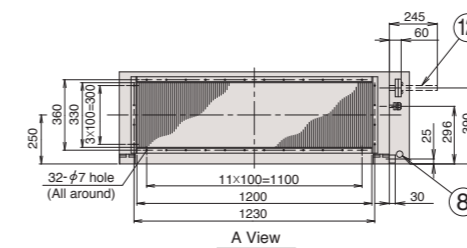

FXMQ125MFV1

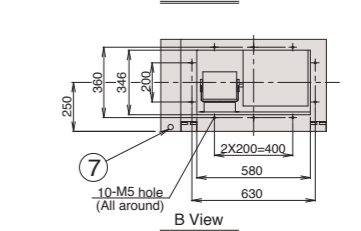
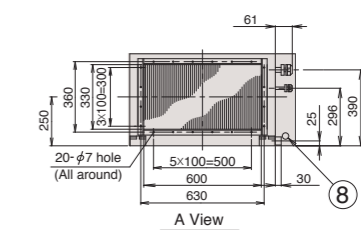

Heat Reclaim Ventilator with DX-Coil and Humidifier — VKM series

The Heat Reclaim Ventilator lineup features the DX-coil in response to recently diversifying outdoor air introduction requirements.

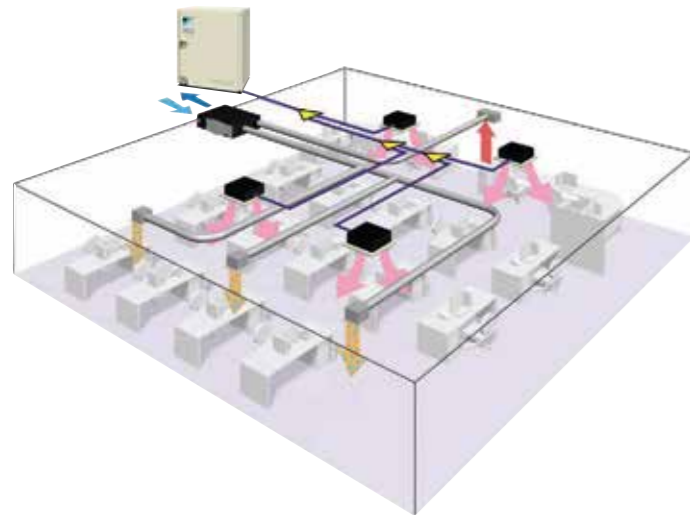

Lineup

With DX Coil & Humidifier Type			
Model Name	VKM50GAMV1	VKM80GAMV1	VKM100GAMV1
Capacity Index	31.25	50	62.5

With DX Coil Type			
Model Name	VKM50GAV1	VKM80GAV1	VKM100GAV1
Capacity Index	31.25	50	62.5



Humidifier

The lineup includes models with a humidifier, in response to diversifying customer requirements. (VKM50/80/100GAMV1 only)

DX-coil

The Heat Reclaim Ventilator features DX-coil that contributes to the prevention of cold airflow hitting people directly during heating operation, due to the after-cool, after-heat operations done beforehand.

High static pressure

High external static pressure means enhanced design flexibility.

Efficient outdoor air introduction is possible

The Heat Reclaim Ventilator (VKM series) series introduces fresh outdoor air with minimum heat losses, while a wide variety of features respond to customer requirements.

Air conditioning and outdoor air processing can be accomplished using a single system.

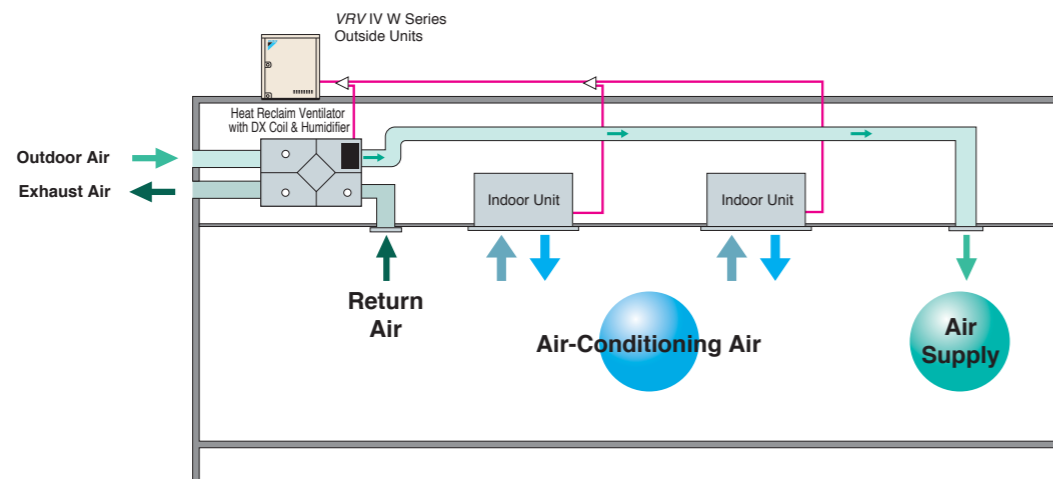

Connection Conditions

The following restrictions must be observed in order to maintain the indoor units connected to the same system.

- When the Heat Reclaim Ventilator VKM series units are connected, the total connection capacity index must be 50% to 130% of the capacity index of the outside units.

A compact unit packed with Daikin's cutting-edge technologies

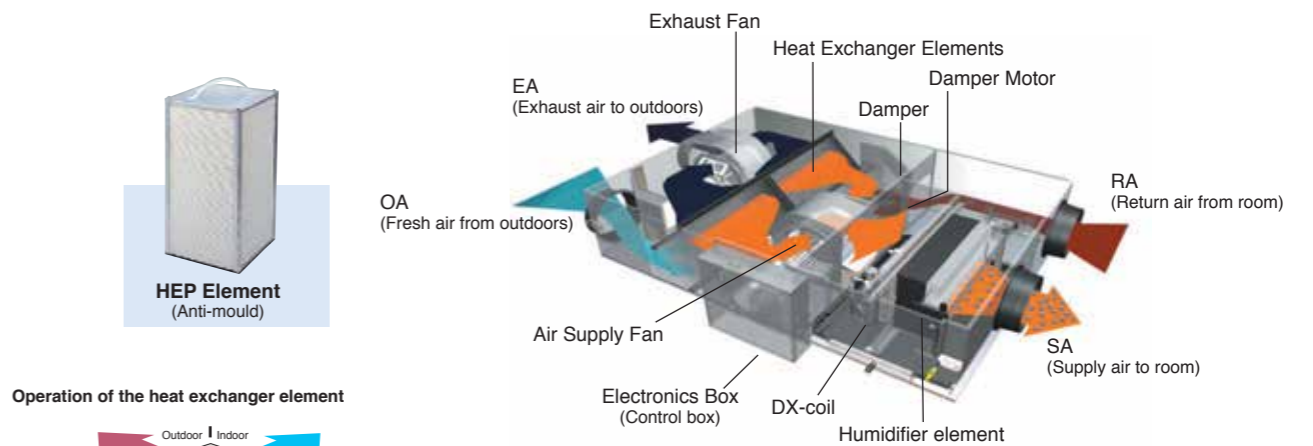

Operation of the heat exchanger element

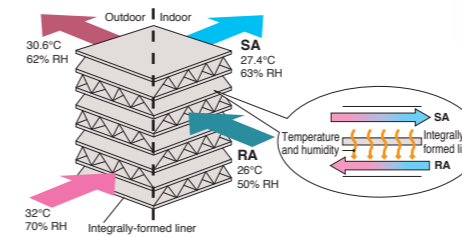

DX-coil (Direct expansion coil)



Humidifier element

Heating and humidification process

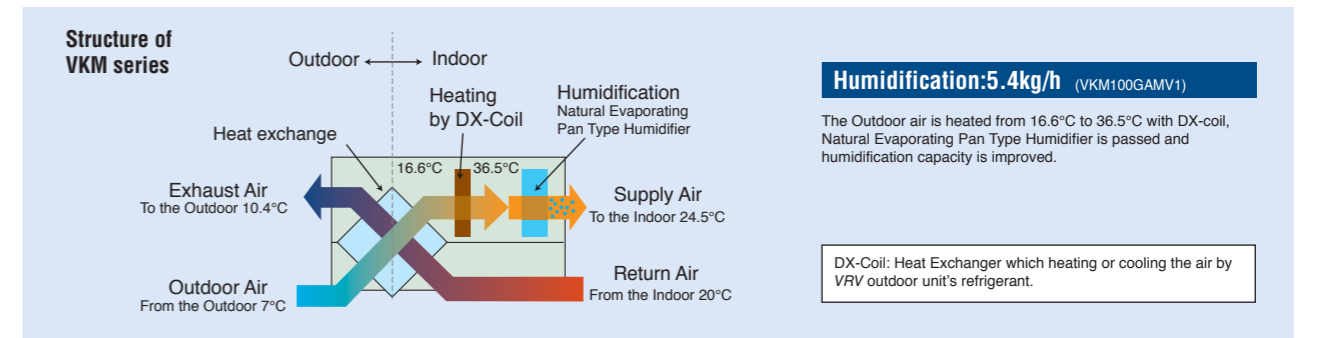

Efficient outdoor air introduction with heat exchanger and cooling/heating operation

Indoor unit with outdoor air treatment

Using outdoor air, the temperature can be brought near room temperature with minimal cooling capacity through the use of outdoor air.

Other features

- Integrated system includes ventilation and humidifying operations.
- Ventilation, cooling/heating and humidifying are possible with one remote controller.

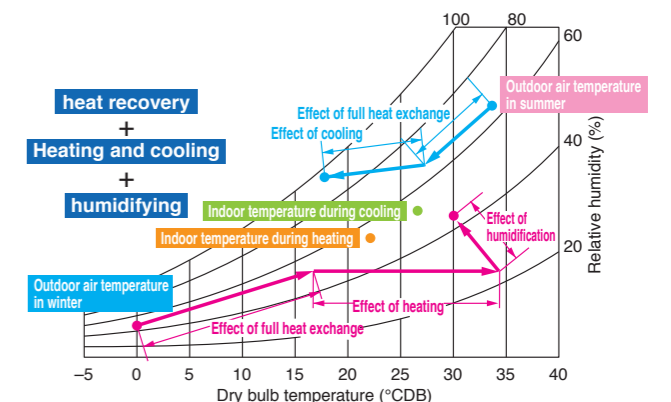

Specifications

MODEL			VKM50GAMV1*	VKM80GAMV1*	VKM100GAMV1*	VKM50GAV1	VKM80GAV1	VKM100GAV1	
Refrigerant			R-410A						
Power Supply			1-phase, 220-240 V, 50 Hz						
Airflow Rate & Static Pressure (Note 7)	Ultra-high	Airflow rate	m ³ /h	500	750	950	500	750	950
		Static pressure	Pa	160	140	110	180	170	150
	High	Airflow rate	m ³ /h	500	750	950	500	750	950
		Static pressure	Pa	120	90	70	150	120	100
	Low	Airflow rate	m ³ /h	440	640	820	440	640	820
		Static pressure	Pa	100	70	60	110	80	70
Power Consumption	Heat exchange mode	Ultra-high	W	560	620	670	560	620	670
		High	W	490	560	570	490	560	570
		Low	W	420	470	480	420	470	480
	Bypass mode	Ultra-high	W	560	620	670	560	620	670
		High	W	490	560	570	490	560	570
		Low	W	420	470	480	420	470	480
Fan Type			Sirocco Fan						
Motor Output			kW						
Sound Level (Note 5) (220/230/240 V)	Heat exchange mode	Ultra-high	dB(A)	37/37.5/38	38.5/39/40	39/39.5/40	38/38.5/39	40/41/41.5	40/40.5/41
		High	dB(A)	35/35.5/36	36/37/37.5	37/37.5/38	36/36.5/37	37.5/38/39	38/38.5/39
		Low	dB(A)	32/33/34	33/34/35.5	34/34.5/35.5	33.5/34.5/35.5	34.5/36/37	35/36/36.5
	Bypass mode	Ultra-high	dB(A)	37/37.5/38	38.5/39/40	39/39.5/40	38/38.5/39	40/41/41.5	40/40.5/41
		High	dB(A)	35/35.5/36	36/37/37.5	37/37.5/38	36/36.5/37	37.5/38/39	38/38.5/39
		Low	dB(A)	32/33/34	33/34/35.5	34/34.5/35.5	33.5/34.5/35.5	34.5/36/37	35/36/36.5
Humidification Capacity (Note 4)			kg/h						
Temp. Exchange Efficiency	Ultra-high	%	76	78	74	76	78	74	
	High	%	76	78	74	76	78	74	
	Low	%	77.5	79	76.5	77.5	79	76.5	
Enthalpy Exchange Efficiency (Cooling)	Ultra-high	%	64	66	62	64	66	62	
	High	%	64	66	62	64	66	62	
	Low	%	67	68	66	67	68	66	
Enthalpy Exchange Efficiency (Heating)	Ultra-high	%	67	71	65	67	71	65	
	High	%	67	71	65	67	71	65	
	Low	%	69	73	69	69	73	69	
Casing			Galvanised Steel Plate						
Insulating Material			Self-Extinguishable Urethane Foam						
Heat Exchanging System			Air to Air Cross Flow Total Heat (Sensible + Latent Heat) Exchange						
Heat Exchanger Element			Specially Processed Nonflammable Paper						
Air Filter			Multidirectional Fibrous Fleeces						
DX-coil Capacity	Cooling (Note 2)	kW	2.8	4.5	5.6	2.8	4.5	5.6	
	Heating (Note 3)	kW	3.2	5.0	6.4	3.2	5.0	6.4	
Dimensions	Height	mm	387	387	387	387	387	387	
	Width	mm	1,764	1,764	1,764	1,764	1,764	1,764	
	Depth	mm	832	1,214	1,214	832	1,214	1,214	
Connection Duct Diameter			mm						
Machine Weight	Net	kg	102	120	125	96	109	114	
	Gross (Note 8)	kg	107	129	134	-	-	-	
Unit Ambient Condition			0°C-40°C DB, 80%RH or less						
			-15°C-40°C DB, 80%RH or less						
			0°C-40°C DB, 80%RH or less						

Notes: 1. Cooling and heating capacities are based on the following conditions. Fan is based on High and Ultra-high. When calculating the capacity as indoor units, use the following figures: VKM50GAMV1/GV1: 3.5 kW, VKM80GAMV1/GV1: 5.6 kW, VKM100GAMV1/GV1: 7.0 kW

2. Indoor temperature: 27°C DB, 19°C WB, Outdoor temperature: 35°C DB

3. Indoor temperature: 20°C DB, Outdoor temperature: 7°C DB, 6°C WB

4. Humidifying capacity is based on the following conditions: Indoor temperature: 20°C DB, 15°C WB, Outdoor temperature: 7°C DB, 6°C WB

5. The operating sound measured at the point 1.5 m below the centre of the unit is converted to that measured in an anechoic chamber built in accordance with the JIS C 1502 conditions. The actual operating sound varies depending on the surrounding conditions (near running unit's sound, reflected sound and so on) and is normally higher than this value. For operation in a quiet room, it is required to take measures to lower the sound. For details, refer to the Engineering Data.

6. The noise level at the air discharge port is about 8-11 dB(A) or higher than the unit's operating sound. For operation in a quiet room, it is required to take measures to lower the sound.

7. Airflow rate can be changed over to Low mode or High mode.

8. In case of holding full water in humidifier.

9. OA: fresh air from outdoor. RA: return air from room.

10. Specifications, design and information here are subject to change without notice.

11. Power consumption and efficiency depend on the above value of airflow rate.

12. Temperature exchange efficiency is the mean value for Cooling and Heating. Efficiency is measured under the following condition: Ratio of rated external static pressure outdoor to indoor is kept constant at 7 to 1.

13. In heating operation, freezing of the outdoor unit's coil increases. Heating capability decreases and the system goes into defrost operation. During defrost operation, the fans of the unit continues driving (factory setting). The purpose of this is to maintain the amount of ventilation and humidifying.

14. When connecting with a VRV system heat recovery outdoor unit and bringing the RA (exhaust gas intake) of this unit directly in from the ceiling, connect to a BS unit identical to the VRV indoor unit (master unit), and use group-linked operation. (See the Engineering Data for details.)

15. When connecting the indoor unit directly to the duct, always use the same system on the indoor unit as with the outdoor unit, perform group-linked operation, and make the direct duct connection settings from the remote controller. (Mode No. "17 (27)" - First code No. "5" - Second code No. "6".) Also, do not connect to the outlet side of the indoor unit. Depending on the fan strength and static pressure, the unit might back up.

* Feed clean water (city water, tap water or equivalent). Dirty water may clog the valve or cause dirt deposits in the water container, resulting in poor humidifier performance. (Never use any cooling tower water and heating-purpose water.) Also, if the supply water is hard water, use a water softener because of short life.

* Life of humidifying element is about 3 years (4,000 hours) under the supply water conditions of hardness: 150 mg/l. (Life of humidifying element is about 1 year (1,500 hours) under the supply water conditions of hardness: 400 mg/l.) Annual operating hours: 10 hours/day x 26 days/month x 5 months = 1,300 hours

Dimensions

VKM50/80/100GA(M)V1

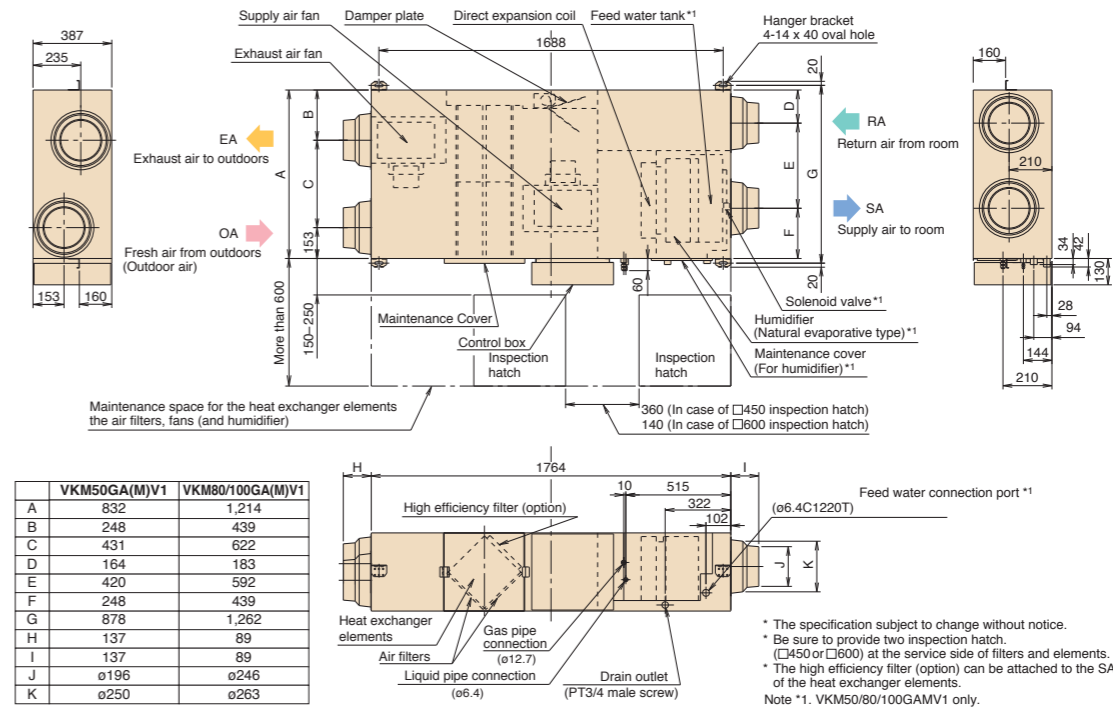

Options

Item	Type	VKM50/80/100GA(M)V1
Remote controller		BRC1E62/BRC1C62 *1
	Centralised controlling device	Residential central remote controller DCS303A51 *2
		Central remote controller DCS302CA61
		Unified ON/OFF controller DCS301BA61
		Schedule timer DST301BA61
Wiring adaptor for electrical appendices		KRP2A61
	For humidifier running ON signal output For heater control kit	KRP50-2 BRP4A50
For wiring	Type (indoor unit of VRV)	FXFQ-S FXFQ-LU FXZQ-M FXCQ-M FXKQ-MA FXDQ-PB FXDQ-NB FXSQ-P FXMQ-P FXMQ-MA FXUQ-A FXHQ-MA FXAQ-P FXLQ-MA FXNQ-MA FXVQ-N
	Installation box for adaptor PCB*	KRP1C63* KRP1B57* KRP1B61* KRP1B61 KRP1B56* KRP1C64* KRP1B61 KRP1C67 KRP1B54 - KRP1B61 KRP1C67 Notes 2, 3 KRP1H98A KRP1BA101 KRP1B96 - Notes 2, 3 KRP1BA101 KRP4A98 KRP4A96 - Note 3 KRP1CA93 KRP4AA93 -

Notes: 1. Installation box * is necessary for each adaptor marked *.

2. Up to 2 adaptors can be fixed for each installation box.

3. Only one installation box can be installed for each indoor unit.

4. Up to 2 installation boxes can be installed for each indoor unit.

5. Installation box * is necessary for second adaptor.

6. Installation box * is necessary for each adaptor.

7. *1 Necessary when operating a Heat Reclaim Ventilator (VKM) independently. When operating interlocked with other air conditioners, use the remote controllers of the air conditioners.

*2 For residential use only. When connected with a Heat Reclaim Ventilator (VKM), you can only switch the power ON/OFF. Cannot be used with other centralised control equipment.

Item	Type	VKM50GA(M)V1	VKM80GA(M)V1	VKM100GA(M)V1	
Additional function	Silencer	-	-	KDDM24B100	
	Air suction/ Discharge grille	Nominal pipe diameter	mm	-	φ 250 mm
		White	K-DGL200B	-	K-DGL250B
	High efficiency filter	Nominal pipe diameter	mm	φ 200	φ 250
Air filter for replacement		KAF242H80M	KAF241G80M	KAF242H100M KAF241G100M	
Flexible duct (1 m)	K-FDS201D	-	K-FDS251D		
Flexible duct (2 m)	K-FDS202D	-	K-FDS252D		

Heat Reclaim Ventilator — VAM series

The Heat Reclaim Ventilator Creates a High-Quality Environment by Interlocking with the Air Conditioner

Model Names

VAM150GJVE, VAM250GJVE, VAM350GJVE, VAM500GJVE, VAM650GJVE, VAM800GJVE, VAM1000GJVE, VAM1500GJVE, VAM2000GJVE



Heat Reclaim Ventilator remote controller* BRC301B61 (Option)
* This remote controller is used in case of independent operation of Heat Reclaim Ventilator.

Improved Enthalpy Efficiency*¹
Higher External Static Pressure*²
Enhanced Energy Saving Functions

This VAM series provides higher enthalpy efficiency*¹, due to the greatly enhanced performance of the thin film element. Furthermore, improved external static pressure*² offers more flexibility for installation. Along with these three outstanding improvements, the nighttime free cooling operation contributes to energy conservation and more comfortable space.

*¹ For models: VAM150/250/350/650/800/1000/2000GJVE
*² For models: VAM150/350/500GJVE

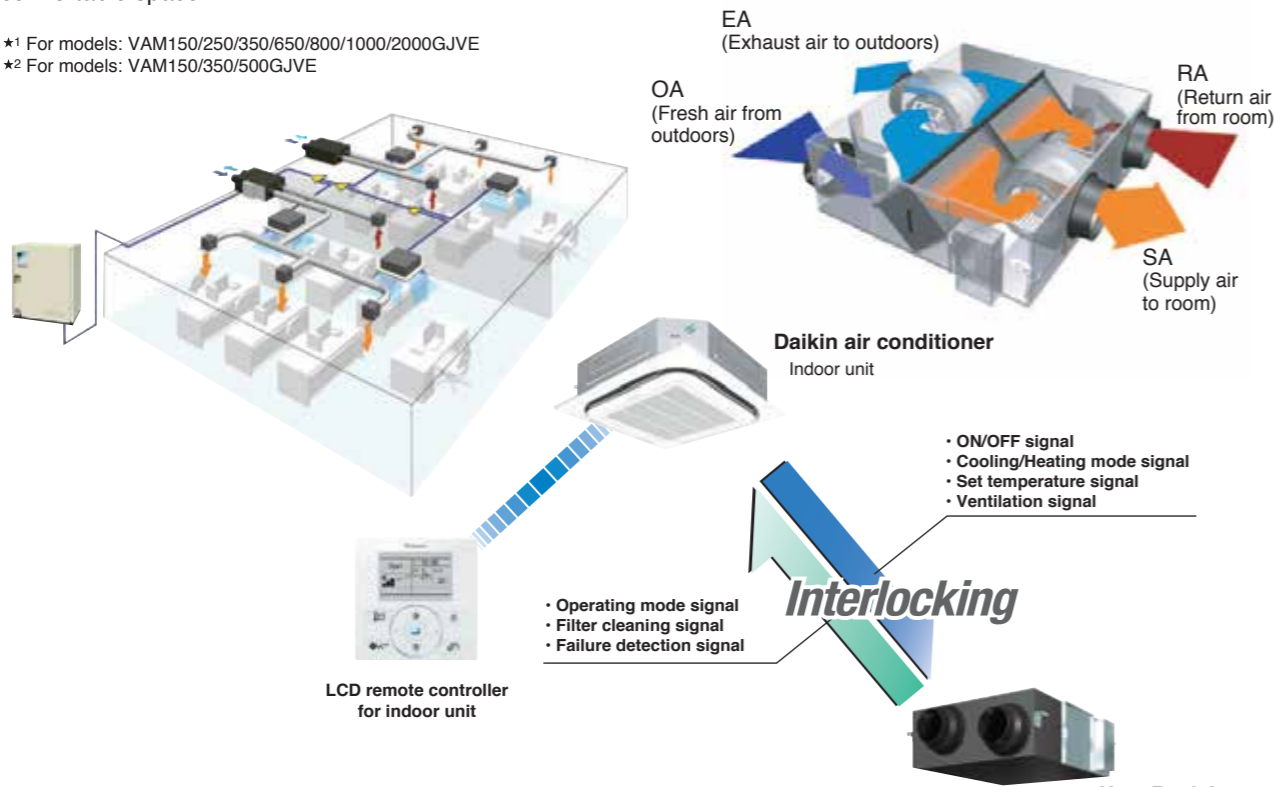

Compact Equipment

With a height of just 306 mm, the unit easily fits in limited spaces, such as above ceilings.

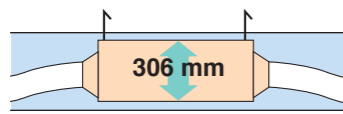

* For VAM500GJVE

Energy Conservation

Air conditioning load reduced by approximately 31%!

Cold Climate Compatible

Standard operation at temperatures down to -15°C.

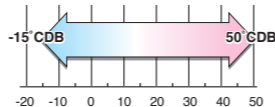

Air conditioning load reduced by approximately 31%!

Total heat exchange ventilation 23%

This unit recovers heat energy lost through ventilation and curbs room temperature changes caused by ventilation, thereby conserving energy and reducing the load on the air conditioning system.

Enthalpy efficiency drastically improved by employing thin film element! (VAM-GJ model)

Due to the thinner film...
• Decreases the moisture resistance of the partition sheets drastically.
• Realises more space for extra layers in the element, resulting in increased effective area that supply and exhaust air can be exposed to.
Moisture absorption increased by approx. 10%!

Thickness of the partition sheet
40 μm

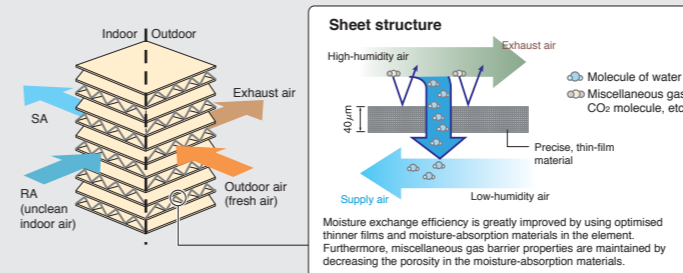

Auto-ventilation Mode Changeover Switching 6%

Automatically switches the ventilation mode (Total Heat Exchange Mode/Bypass Mode) according to the operating status of the air conditioner.

Pre-cool, Pre-heat Control 2%

Reduces air conditioning load by not running the Heat Reclaim Ventilator while air is still clean soon after the air conditioner is turned ON.

Air Conditioning Load Reduced by Approximately 31%

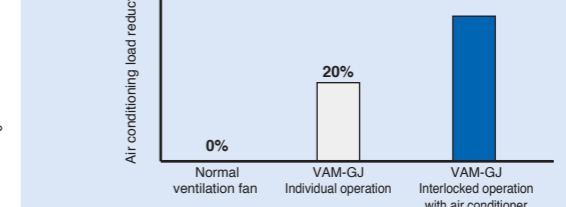

• The air conditioning load reduction values may vary according to weather and other environmental conditions at the location of the machine's installation.
• The air conditioning load reduction values are based on the following conditions:
Application: Tokyo office building
Building form: 6 floors above ground, 2 floors underground, floor area 2,100 m²
Personnel density: 0.25 person/m²
Ventilation volume: 25 m³/h
Indoor air conditioning level: summer 25°C 50% RH, intermediate seasons 24°C 50% RH, winter 22°C 40% RH
Operating time: 2745 hours (9 hours per day, approx. 25 days per month)
Calculation method: simulation based on "MICRO-HASP/1982" of the Japan Building Mechanical and Electrical Engineers Association.

Nighttime free cooling operation*¹

Nighttime free cooling operation is an energy-conserving function that works at night when air conditioners are off. By ventilating rooms containing office equipment that raises the room temperature, nighttime free cooling operation reduces the cooling load when air conditioners are turned on in the morning. It also alleviates feelings of discomfort in the morning caused by heat accumulated during the night.

• Nighttime free cooling operation only works to cool and if connected to Building Multi or VRV systems.
• Nighttime free cooling operation is set to "off" in the factory settings, so if you wish to use it, request your dealer to turn it on.

*¹ This function can be operated only when interlocked with air conditioners.
*² Value is based on the following conditions:
• Cooling operation performed from April to October.
• Calculated for air conditioning sensible heat load only (latent heat load not included).

Air conditioning sensible heat load reduced by **approx. 5%²!**

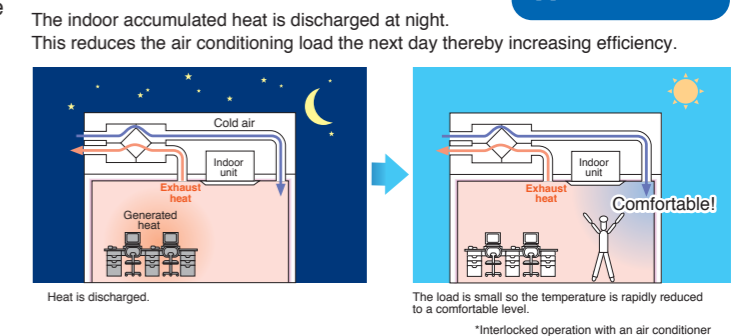

Heat Reclaim Ventilator — VAM series

CO₂ Sensor Optional Kit Connection

The CO₂ sensor controls airflow so that it best matches the changes in CO₂ level. This prevents energy losses from over-ventilation while maintaining indoor air quality with optional CO₂ sensor.

Example of CO₂ sensor operation in an office room:

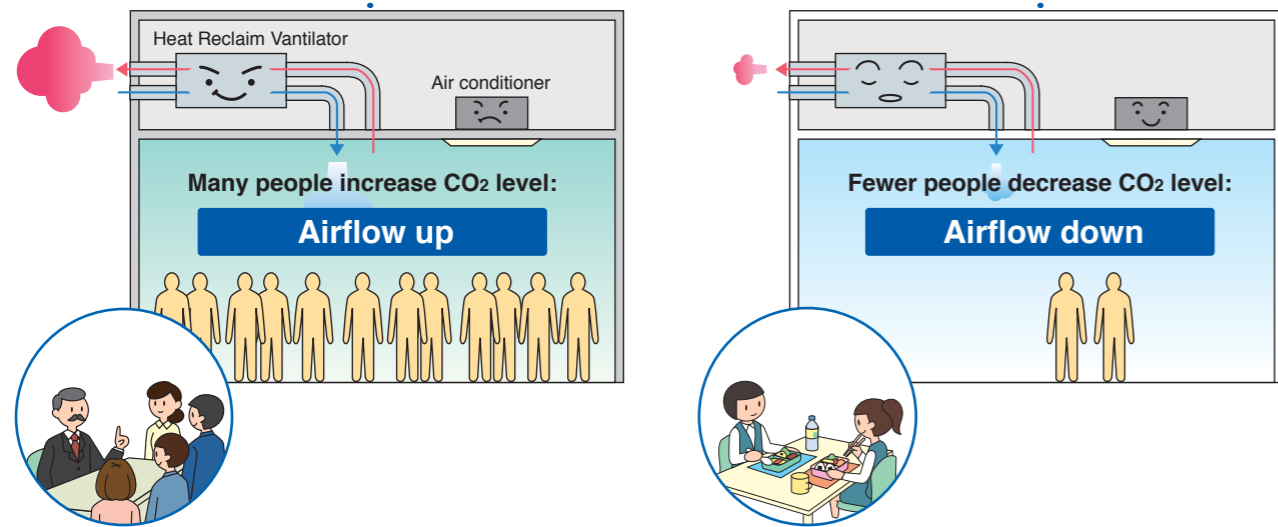
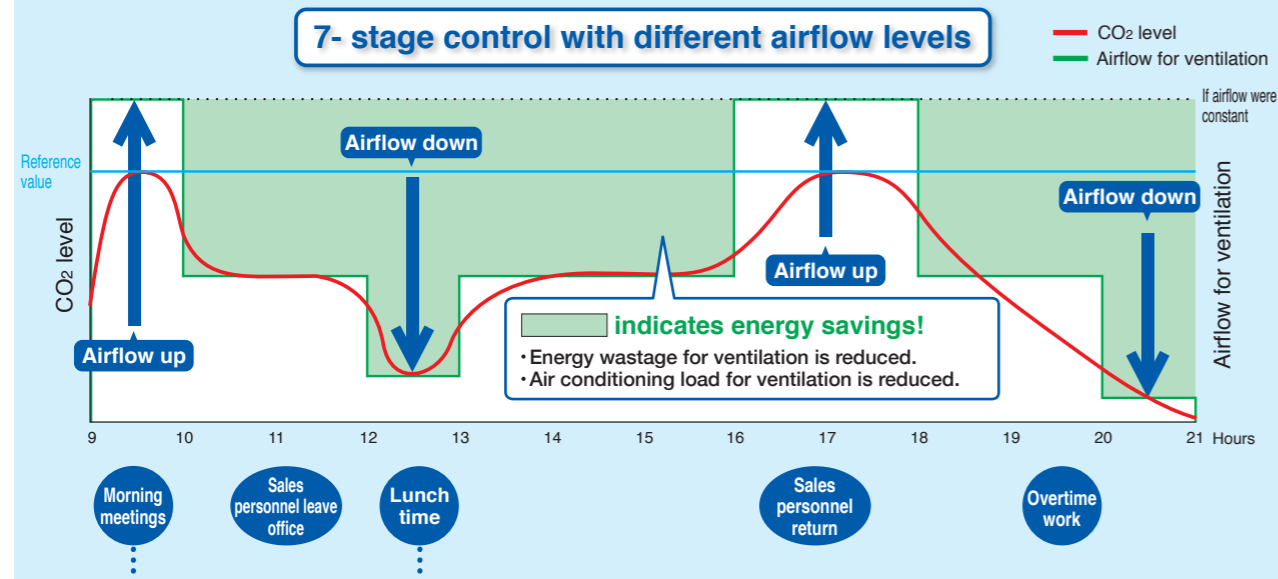

Heat Reclaim Ventilator — PM2.5 filtration unit (Option)

Rapid urbanization has increased industrial and automobile emissions, resulting in higher PM2.5 levels. This has become the source of respiratory diseases and poses a serious threat to a long term health issue. As the air quality has worsened, research has shown the harmful effects of PM2.5 on the health of the general public.

Double-layered efficient filtration

PM2.5 filters are double-layered.
 1. The front filter effectively removes large particles.
 2. The PM2.5 filter layer contains a large amount of static electricity to capture particulate matter efficiently.

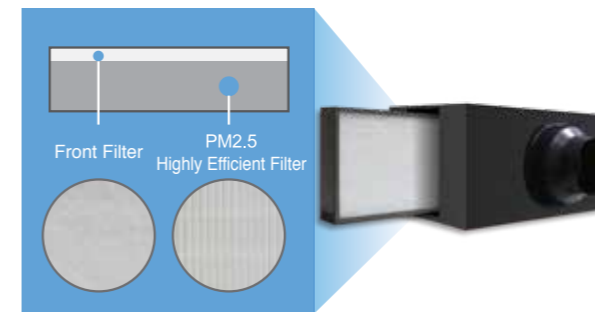

Electrostatic dust collection filter: more efficient and longer lasting effect

The PM2.5 filter layer contains a large amount of static electricity to capture particulate matter efficiently, including those smaller than the grid mesh. The filter is difficult to be blocked by particles and has good ventilation and long life span.

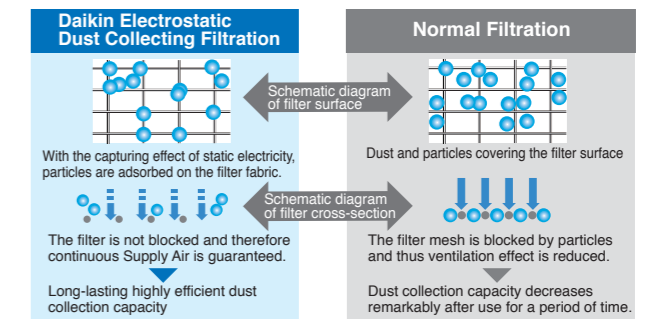

Filtering PM2.5 efficiently for healthier and more comfortable environments

The PM2.5 filtering series heat reclaim ventilator is equipped with an electrostatic dust collection filter for PM2.5 removal. This filter not only removes 99% or more of 2.5 μm; it also eliminates up to 90% of 0.5 μm matter!

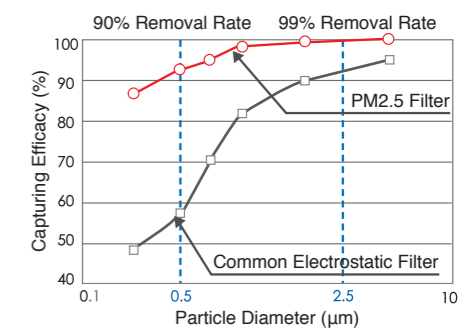
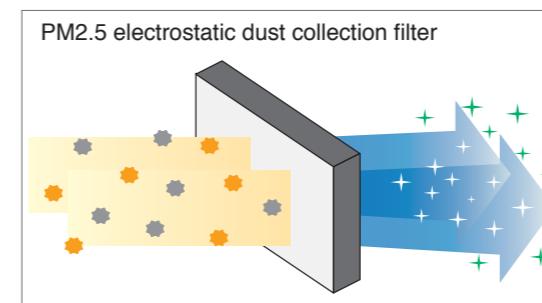

*Test results by the Heating, Ventilation and Air Conditioning Lab at Tongji University
 Test environment: temperature 25-26°CDB, humidity 58-60%RH

Extra-High Performance Filter Against Sulfur Oxides and Nitrogen Oxides

Effective Use of Active Carbon Material to Enlarge the Adsorption Area

As an expert in the research and development of filters, DAIKIN has specifically selected active carbon material as the main substance to constitute the filter against sulfur oxides and nitrogen oxides. The material's usable pore surface is fully exploited, thus extending the filter's durability.

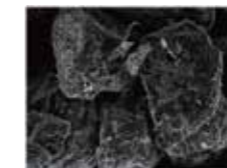

Note: Surface area of active carbon: 700 m²/g
 Given a newspaper page of 40.6 cm wide by 54.6 cm long, each gram of active carbon has a surface area of 3,000 newspaper pages.

Intelligent Identification, Super-effective Adhesion

The special substance added in the pores of active carbon can exclusively target sulfur oxide and nitrogen oxide gases and stick to them without blocking other unidentified gases. This ensures long durability of the filter.

Unidentified Gases

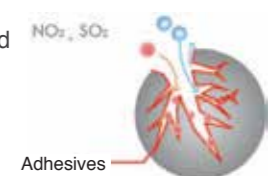

Adhesives

Note: The figures are based on in-house tests under the following lab conditions:
 temperature 22 to 25°CDB, humidity 35 to 40% RH, air flow rate 0.2 m/s.

Specifications

Heat Reclaim Ventilator — VAM series

MODEL		VAM150GJVE	VAM250GJVE	VAM350GJVE	VAM500GJVE	VAM650GJVE	VAM800GJVE	VAM1000GJVE	VAM1500GJVE	VAM2000GJVE					
Power Supply		1-phase, 220-240 V/ 220 V, 50/60 Hz													
Temp. Exchange Efficiency (50/60 Hz)	Ultra-High	79/79	75/75	79/79	74/74	75/75	72/72	78/78	72/72	77/77					
	High	79/79	75/75	79/79	74/74	75/75	72/72	78/78	72/72	77/77					
	Low	84/85	79/79	82/82	80/80.5	77/77.5	74/74.5	80.5/81	75.5/76	79/81					
Enthalpy Exchange Efficiency (50/60 Hz)	Ultra-High	66/66	63/63	66/66	55/55	61/61	61/61	64/64	61/61	62/62					
	High	66/66	63/63	66/66	55/55	61/61	61/61	64/64	61/61	62/62					
	Low	70/70.5	66/66	70/70	59/59.5	64/64.5	64/64.5	68.5/69	64/64.5	66/67					
Power Consumption (50/60 Hz)	Heat Exchange Mode	Ultra-High	125/134	137/141	200/226	248/270	342/398	599/680	635/760	1,145/1,300	1,289/1,542				
		High	111/117	120/125	182/211	225/217	300/332	517/597	567/648	991/1,144	1,151/1,315				
		Low	57/58	60/59	122/120	128/136	196/207	435/483	476/512	835/927	966/1,039				
	Bypass Mode	Ultra-High	125/134	137/141	200/226	248/270	342/398	599/680	635/760	1,145/1,300	1,289/1,542				
		High	111/117	120/125	182/211	225/217	300/332	517/597	567/648	991/1,144	1,151/1,315				
		Low	57/58	60/59	122/120	128/136	196/207	435/483	476/512	835/927	966/1,039				
Sound Level (50/60 Hz)	Heat Exchange Mode	Ultra-High	27-28.5/28.5	27-29/29	31.5-33/33	33-35.5/34	34-36/36	39-40.5/39.5	39.5-41.5/39.5	39.5-41.5/41.5	41.5-43.5/42				
		High	26-27.5/27.5	26-27.5/28	30-31.5/30	31.5-34/32	33-34.5/34	37-39.5/37.5	37.5-39.5/37.5	37.5-39.5/39.5	39-43/40				
		Low	20.5-21.5/21	21-22/21	23-25/23	25-28.5/24	27.5-29.5/28	35-37.5/34	35-37.5/34.5	35-37.5/36	36-39/39				
	Bypass Mode	Ultra-High	28.5-29.5/29.5	28.5-30.5/30.5	33-34.5/34.5	34.5-36/35.5	35-37.5/37.5	40.5-42/41	40.5-42.5/40.5	41-43/42.5	43-45.5/44				
		High	27.5-28.5/28.5	27.5-29/29.5	31.5-33/31.5	33-34.5/33.5	33-35.5/35.5	38.5-40/39	38.5-40.5/38.5	39.5-41/41.5	40.5-45/42				
		Low	22.5-23.5/22.5	22.5-23/22.5	24.5-26.5/24.5	25.5-28.5/25.5	27.5-30.5/29.5	36-38.5/35.5	36-38.5/35.5	36.5-38/37.5	37.5-39.5/41				
Casing		Galvanised steel plate													
Insulation Material		Self-extinguishable polyurethane foam													
Dimensions (HXWXD)	mm	278×810×551		306×879×800		338×973×832		387×1,111×832		387×1,111×1,214		785×1,619×832		785×1,619×1,214	
Machine Weigh	kg	24		32		45		55		67		129		157	
Heat Exchange System		Air to air cross flow total heat (Sensible heat + latent heat) exchange													
Heat Exchange Element Material		Specially processed nonflammable paper													
Air Filter		Multidirectional fibrous fleeces													
Fan	Type	Sirocco fan													
	Airflow Rate (50/60 Hz)	Ultra-High	150/150	250/250	350/350	500/500	650/650	800/800	1,000/1,000	1,500/1,500	2,000/2,000				
		High	150/150	250/250	350/350	500/500	650/650	800/800	1,000/1,000	1,500/1,500	2,000/2,000				
		Low	100/95	155/155	230/230	320/295	500/470	700/670	860/840	1,320/1,260	1,720/1,580				
	External Static Pressure (50/60 Hz)	Ultra-High	120/154	70/96	169/222	105/150	85/125	133/170	168/192	112/150	116/140				
		High	106/131	54/65	141/145	66/52	53/67	92/85	110/86	73/72	58/32				
Low		56/60	24/20	67/30	32/18	35/38	72/61	85/60	56/50	45/45					
Motor Output	kW	0.030×2		0.090×2		0.140×2		0.280×2		0.280×4					
Connection Duct Diameter	mm	φ 100		φ 150		φ 200		φ 250		φ 350					
Unit ambient condition		-15°C—50°CDB, 80%RH or less													

- Notes:
1. Sound level is measured at 1.5m below the centre of the body.
 2. Airflow rate can be changed over to Low mode or High mode.
 3. Sound level is measured in an anechoic chamber. Sound level generally becomes greater than this value depending on the operating conditions, reflected sound, and peripheral noise.
 4. The sound level at the air discharge port is about 8 dB(A) higher than the unit's sound level.
 5. The specifications, designs and information given here are subject to change without notice.
 6. Temperature Exchange Efficiency is the mean value between cooling and heating.
 7. Efficiency is measured under the following conditions: Ratio of rated external static pressure has been maintained as follows; outdoor side to indoor side = 7 to 1.
 8. In conformance with JIS standards (JIS B 8628), operating sound level is based on the value when one unit is operated, with the value converted for an anechoic chamber. This is transmission sound from the main unit, and does not include sound from the discharge grille. Thus it is normal for the sound to be louder than the indicated value when the unit is actually installed.
 9. Sound level from the discharge port causes the value to be approximately 8 dB(A) (models with the airflow rate of less than 150 to 500m³/h) to approximately 11 dB(A) (models with the airflow rate of 650m³/h or more) greater than the indicated value. Furthermore, fan rotation and noise from the discharge grille

- may increase depending on the on-site duct resistance conditions. Please consider noise countermeasures when installing the unit.
10. With large models in particular (1500 and 2000m³/h models), if the supply air (SA) grille is installed near the main unit, the noise of the main unit may be heard from the discharge grille via the duct, and this will result in a marked increase in noise. In such cases, if peripheral effects are included (such as reverberation of the floor and walls, combination with other equipment, and background noise), sound level may be as much as 15 dB(A) higher than the indicated value. When installing a large model, please provide as much separation as possible between the main unit and the discharge grille. If the equipment and discharge grille are near each other, please consider countermeasures such as the following:
 - Use a sound-muffling box, flexible duct and sound-muffling air supply/discharge grilles
 - Decentralised installation of discharge grilles
 11. When installing in a location with particularly low background noise such as a classroom, please consider the following measures to avoid transmission sound from the main unit:
 - Use of ceiling materials with high sound insulating properties (high transmission loss)
 - Methods of blocking sound transmission, for example, by adding sound insulating materials around the bottom of the sound source.
 Alternatively, consider supplementary methods such as installing the equipment in a different location (corridor, etc.)

PM2.5 Filtration Unit

Models		BAF249A150	BAF249A300	BAF249A350	BAF249A500
Heat Reclaim Ventilator Models		VAM150GJVE	VAM250GJVE	VAM350GJVE	VAM500GJVE
Dimensions (H x W x D)		mm	220 x 603 x 366	220 x 603 x 366	300 x 623 x 366
Connection Duct Diameter		mm	Ø100	Ø150	Ø150
Airflow Rate		m ³ /h	150	250	350
PM2.5 Filter	Initial Pressure Drop	Pa	34	30	31
	Filter Lifetime ¹	1 year			
	Filtration Efficiency ²	99% or higher			
	Filter Material No. ³	BAF244A300		BAF244A500	

- Notes:
1. Annual usage: 400 hrs/month x 12 months = 4,800 hrs
 2. 99% or higher removal rate of ultra-fine particles with diameters of 2.5 µm or more; 90% or higher removal rate of ultra-fine particles with diameters of 0.5 µm.
 3. Filters come with applicable filtration units with a one-year life. They can be purchased and replaced according to their model numbers.

PM2.5 with Activated Carbon Filtration Unit

Models		BAF249A150C	BAF249A300C	BAF249A350C	BAF249A500C
Heat Reclaim Ventilator Models		VAM150GJVE	VAM250GJVE	VAM350GJVE	VAM500GJVE
Dimensions (H x W x D)		mm	220×603×366	220×603×366	300×623×366
Connection Duct Diameter		mm	Ø100	Ø150	Ø150
Airflow Rate		m ³ /h	150	250	350
PM2.5 Filter	Initial Pressure Drop	Pa	34	30	31
	Filter Lifetime ¹	1 year			
	Filtration Efficiency ²	99% or higher			
	Filter Material No. ³	BAF244A300		BAF244A500	
Activated Carbon Filter	Initial Pressure Drop	Pa	3	5	5
	Filter Lifetime	1 year			
	Filter Material No. ³	BAF244A300C		BAF244A500C	
Total Initial Pressure Drop for PM2.5 with Activated Carbon Filtration Unit		Pa	37	35	36
					51

- Notes:
1. Annual usage: 400 hrs / month x 12 months = 4,800 hrs.
 2. 99% or higher removal rate of ultra-fine particles with diameters of 2.5 µm or more; 90% or higher removal rate of ultra-fine particles with diameters of 0.5 µm.
 3. Filters come with applicable filtration units with a one-year life. They can be purchased and replaced according to their model numbers.

Options

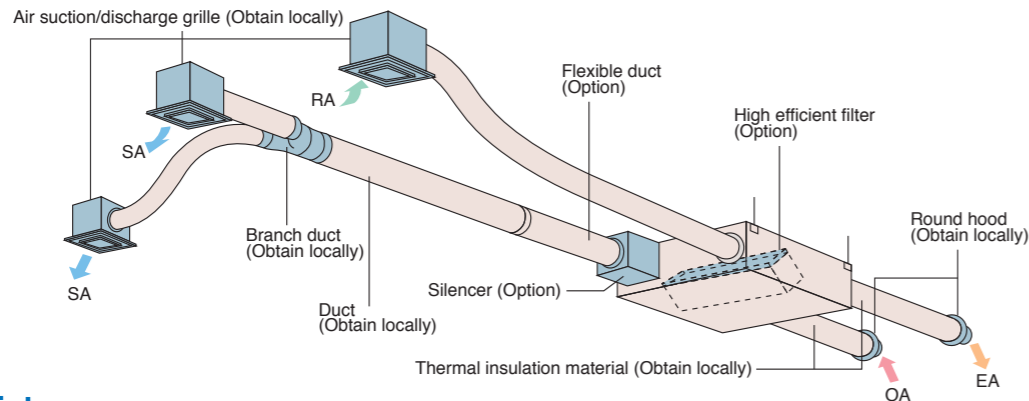

Option List

Item	Type	VAM150 · 250 · 350 · 500 · 650 · 800 · 1000 · 1500 · 2000GJVE														
Controlling device	Heat Reclaim Ventilator remote controller	BRC301B61														
	Centralised controlling device	Residential central remote controller	DCS303A51 *1													
		Central remote controller	DCS302CA61													
		Unified ON/OFF controller	DCS301BA61													
		Schedule timer	DST301BA61													
PC Board Adaptor	Wiring adaptor for electrical appendices	KRP2A61														
	For humidifier	KRP50-2														
	Installation box for adaptor PCB	KRP50-2A90 (Mounted electric component assy of Heat Reclaim Ventilator)														
	For heater control kit	BRP4A50														
For wiring (indoor unit of VRV)	Type	FXFQ-S	FXZQ-M	FXCQ-M	FXKQ-MA	FXDQ-PB	FXDQ-NB	FXSQ-P	FXMQ-P	FXMQ-MA	FXUQ-A	FXHQ-MA	FXAQ-P	FXLQ-MA	FXNQ-MA	FXVQ-N
		KRP1C63*	KRP1B57*	KRP1B61*	KRP1B61	KRP1B56*	KRP1C64*	KRP1B61	KRP1C67	KRP1B61	KRP1C67	KRP1BA54	—	KRP1B61	KRP1C67	—
Installation box for adaptor PCB*		Notes 2, 3 KRP1H98A	Note 4, 6 KRP1BA101	Notes 2, 3 KRP1B96	—	Notes 4, 6 KRP1BA101	Notes 2, 3 KRP4A98	Notes 2, 3 KRP4A96	—	—	Note 3 KRP1CA93	Notes 2, 3 KRP4AA93	—	—	—	—

Notes: 1. Installation box * is necessary for each adaptor marked *.
 2. Up to 2 adaptors can be fixed for each installation box.
 3. Only one installation box can be installed for each indoor unit.
 4. Up to 2 installation boxes can be installed for each indoor unit.
 5. Installation box * is necessary for second adaptor.
 6. Installation box * is necessary for each adaptor.
 7. *1 For residential use only. When connected with a Heat Reclaim Ventilator (VAM), you can only switch the power ON/OFF. Cannot be used with other centralised control equipment.

Item	Type	VAM150GJVE	VAM250GJVE	VAM350GJVE	VAM500GJVE	VAM650GJVE	VAM800GJVE	VAM1000GJVE	VAM1500GJVE	VAM2000GJVE
Additional function	Silencer	—	—	—	KDDM24B50	—	KDDM24B100	—	KDDM24B100X2	—
	Nominal pipe diameter mm	—	—	—	φ 200	—	φ 250	—	φ 250	—
	High efficiency filter	KAF242H25M	—	KAF242H50M	KAF242H65M	KAF242H80M	KAF242H100M	KAF242H80MX2	KAF242H100MX2	—
	Air filter for replacement	KAF241G25M	—	KAF241G50M	KAF241G65M	KAF241G80M	KAF241G100M	KAF241G80MX2	KAF241G100MX2	—
	Flexible duct (1 m)	K-FDS101D	K-FDS151D	—	K-FDS201D	—	—	K-FDS251D	—	—
	Flexible duct (2 m)	K-FDS102D	K-FDS152D	—	K-FDS202D	—	—	K-FDS252D	—	—
	Duct adaptor	—	—	—	—	—	—	YDFA25A1	—	—
	Nominal pipe diameter mm	—	—	—	—	—	—	φ 250	—	—
	CO ₂ sensor	—	—	—	BRYMA65	—	BRYMA100	BRYMA65	BRYMA100	—

PC board adaptor for heater control kit (BRP4A50)

When the installation of an electric heater is required in a cold region, this adaptor with an internal timer function eliminates the complicated timer connecting work that was necessary with conventional heaters.

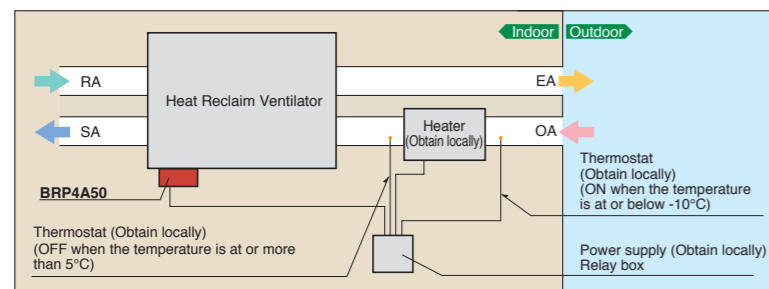

Notes when installing

- Examine fully an installation place and specification for using the electric heater based on the standard and regulation of each country.
- Supply the electric heater and safety production devices such as a relay and a thermostat, etc of which qualities satisfy the standard and regulation of each country at site.
- Use a non-inflammable connecting duct to the electric heater. Be sure to allow 2 m or more between the electric heater and the Heat Reclaim Ventilator for safety.
- For the Heat Reclaim Ventilator, use a different power supply from that of the electric heater and install a circuit breaker for each.

Air Handling Unit

Integrate your air handling unit in a total solution for large size spaces such as factories and large stores.

AHUR
Capacity range : 8 ñ 120 HP



- Easy design and installation
- The system is easy to design and install since no additional water systems such as boilers, tanks and gas connections etc are required.
- Inverter controlled units
- Control of air temperature via standard Daikin wired remote control for standard series



System overview



— Daikin communication wire (F1, F2 communication) — Liquid pipe
 — Other communication wire — Gas pipe

Daikin air handling units can be connected to VRV IV W series. This combination can be built to order as a system. Outdoor air series is also possible. Please contact your local sales office for details.