



PCSID2405

SkyAir

INVERTER

ROUND FLOW



AIR CONDITIONING SYSTEM
COOLING ONLY [50Hz]



Perfecting the Air

- Ask a qualified installer or contractor to install this product. Do not try to install the product yourself. Improper installation can result in water or refrigerant leakage, electrical shock, fire or explosion.
- Use only those parts and accessories supplied or specified by Daikin. Ask a qualified installer or contractor to install those parts and accessories. Use of unauthorised parts and accessories or improper installation of parts and accessories can result in water or refrigerant leakage, electrical shock, fire or explosion.
- Read the user's manual carefully before using this product. The user's manual provides important safety instructions and warnings. Be sure to follow these instructions and warnings.

If you have enquiries, please contact your local importer, distributor and/or retailer.

DEALER RESMI

Cautions on product corrosion

1. Air conditioners should not be installed in areas where corrosive gases, such as acid gas or alkaline gas, are produced.
2. If the outdoor unit is to be installed close to the sea shore, direct exposure to the sea breeze should be avoided. If you need to install the outdoor unit close to the sea shore, contact your local distributor.

DCC 0800 1 081 081
DAIKIN CONTACT CENTER

Jam Beroperasi:

Senin - Jumat: 07:00 - 19:00 WIB

Sabtu - Minggu & Libur Nasional: 07:00 - 17:00 WIB

PT. DAIKIN AIRCONDITIONING INDONESIA

Menara Astra 7th & 8th Floor, Jl. Jenderal Sudirman Kav. 5-6,
Kel. Karet Tengsin, Kec. Tanah Abang, Jakarta Pusat, DKI Jakarta - 10220
Telp : +6221 8665 6886 | Website : www.daijin.co.id

• **SERVICE CENTER** : Jakarta Selatan, Telp. : 021-2782 5545 | Samarinda, Telp. : 0541-252 2889 • **WORKSHOP** : Cirebon, Telp. : 0231-8817 512 | Banjarmasin, Tlp. : 0511-3258 969 | Aceh, Tlp. : 0651-7318 036 | Lombok, Tlp. : 0370-7843 231 | Jambi, Tlp. : 0741-3066 790 | Padang, Tlp. : 0751-896 2684 • **TRAINING CENTER** : Sunter, Telp. : 021-650 5030 • **BRANCH** : Bekasi, Telp. : 021-2945 0585 | Tangerang, Telp. : 021-5314 1195 | Bandung, Telp. : 022-522 5150 | Semarang, Telp. : 024-7660 3221 | Yogyakarta, Telp. : 0274-551 321 | Surabaya, Telp. : 031-503 1138 | Denpasar, Telp. : 0361-900 5514 | Makassar, Telp. : 0411-805 2691 | Palembang, Telp. : 0711-573 2282 | Pekanbaru, Telp. : 0761-561 139 | Medan, Telp. : 061-4200 8866 | Manado, Telp. : 0431-719 1199 | Batam, Tlp. : 0778-4171 445



Management System
ISO 9001:2015

www.tuv.com
ID 9105084313



R-32

Designed for use in cafe and restaurants, retail shops and small offices.



Daikin's SkyAir series delivers superior comfort and energy performance for both occupants and building owners.



INDEX

Lineup	P.3-4
Daikin SkyAir Series	
Energy Saving	P.5
Benefits of Inverters	P.6
Durability	P.7
Design Flexibility	P.8
Smart Airflow Control	P.9
Compact & Lightweight	P.10
Indoor Unit	
Ceiling Mounted Cassette type <Round Flow>	P.11-16
Compact Multi Flow Ceiling Mounted Cassette Type	P.17-18
Ceiling Suspended type	P.19-20
Duct Connection Low Static Pressure Width Compact type	P.21-22
Duct Connection Low Static Pressure Height Compact type	P.23-24
Duct Connection Middle Static Pressure type	P.25-26
Outdoor Unit	P.27
Remote Controller	P.28-30
Functions	P.31-34
Specifications	P.35-40
Options	P.41-43
Dimensions	P.44-57
Installation Service Space for Outdoor Unit	P.58



	35	40	50	60
CEILING MOUNTED CASSETTE TYPE ROUND FLOW <Round Flow>				
	Indoor unit	FCFC40DVM4	FCFC50DVM4	FCFC60DVM4
Outdoor unit	RZFC40DVM4	RZFC50DVM4	RZFC60DVM4	
COMPACT MULTI FLOW CEILING MOUNTED CASSETTE TYPE NEW				
	Indoor unit	FFFC35AVM4	FFFC50AVM4	FFFC60AVM4
Outdoor unit	RZFC35EVM4		RZFC50DVM4	RZFC60DVM4
CEILING SUSPENDED TYPE				
	Indoor unit	FHFC40DV14	FHFC50DV14	FHFC60DV14
Outdoor unit	RZFC40DVM4	RZFC50DVM4	RZFC60DVM4	
DUCT CONNECTION LOW STATIC PRESSURE WIDTH COMPACT TYPE				
	Indoor unit	FDBF40DV14	FDBF50DV14	FDBF60DV14
Outdoor unit	RZFC40DVM4	RZFC50DVM4	RZFC60DVM4	
DUCT CONNECTION LOW STATIC PRESSURE HEIGHT COMPACT TYPE				
	Indoor unit	FDLF40DV14	FDLF50DV14	FDLF60DV14
Outdoor unit	RZFC40DVM4	RZFC50DVM4	RZFC60DVM4	
DUCT CONNECTION LOW STATIC PRESSURE HEIGHT COMPACT TYPE				
	Indoor unit	FBFC40DVM4	FBFC50DVM4	FBFC60DVM4
Outdoor unit	RZFC40DVM4	RZFC50DVM4	RZFC60DVM4	

OUTDOOR UNIT NEW	35	40	50	60
	Outdoor unit			
Power supply	RZFC35EVM4 1 phase, 220-240 V, 50Hz	RZFC40DVM4 1 phase, 220-240 V, 50Hz	RZFC50DVM4 1 phase, 220-240 V, 50Hz	RZFC60DVM4 1 phase, 220-240 V, 50Hz

	71	85	100	125	140	
						Page 11
	Indoor unit	FCFC71DVM4	FCFC85DVM4	FCFC100DVM4	FCFC125DVM4	
Outdoor unit	RZFC71DVM4 RZFC71DY14	RZFC85DVM4 RZFC85DY14	RZFC100DVM4 RZFC100DY14	RZFC125DY14	RZFC140DY14	
						Page 17
	Indoor unit	FFFC71AVM4				
Outdoor unit	RZFC71DVM4					
						Page 19
	Indoor unit	FHFC71DV14	FHFC85DV14	FHFC100DV14	FHFC125DV14	
Outdoor unit	RZFC71DVM4 RZFC71DY14	RZFC85DVM4 RZFC85DY14	RZFC100DVM4 RZFC100DY14	RZFC125DY14	RZFC140DY14	
						Page 21
	Indoor unit	FDBF71DV14	FDBF85DV14			
Outdoor unit	RZFC71DVM4 RZFC71DY14	RZFC85DVM4 RZFC85DY14				
						Page 23
	Indoor unit	FDLF71DV14	FDLF85DV14			
Outdoor unit	RZFC71DVM4 RZFC71DY14	RZFC85DVM4 RZFC85DY14				
						Page 25
	Indoor unit	FBFC71DVM4	FBFC85DVM4	FBFC100DVM4	FBFC125DVM4	
Outdoor unit	RZFC71DVM4 RZFC71DY14	RZFC85DVM4 RZFC85DY14	RZFC100DVM4 RZFC100DY14	RZFC125DY14	RZFC140DY14	

OUTDOOR UNIT NEW	71	85	100	125	140	
	Outdoor unit					
Power supply	RZFC71DVM4 1 phase, 220-240 V, 50Hz	RZFC71DY14 3 phase, 380-415V, 50Hz	RZFC85DVM4 1 phase, 220-240 V, 50Hz	RZFC85DY14 3 phase, 380-415V, 50Hz	RZFC100DVM4 1 phase, 220-240 V, 50Hz	RZFC100DY14 3 phase, 380-415V, 50Hz
				RZFC125DY14 3 phase, 380-415V, 50Hz	RZFC140DY14 3 phase, 380-415V, 50Hz	

New Inverters launched

SkyAir

R-32

Cooling only

Energy Saving

Throughout the cooling season, Daikin's new inverter models reduce energy consumption

Compared with previous non-inverter series, the new RZFC-D series uses about 35% less power consumption for quick and effective cooling that reduces electricity bills.

Comparison of cooling seasonal power consumption based on average CSPF values

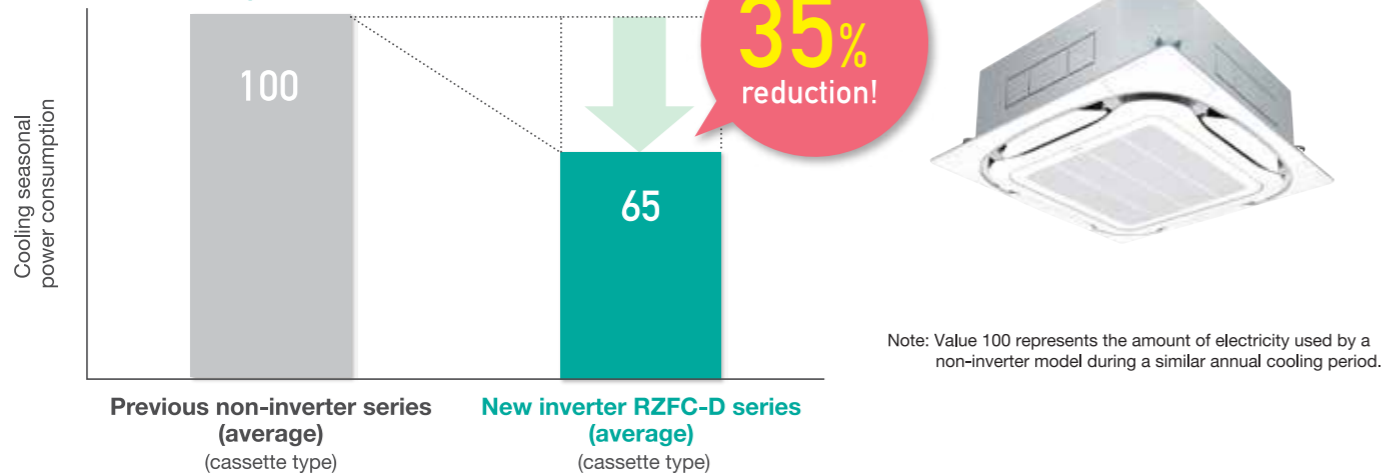

CSPF values by capacity for cassette models

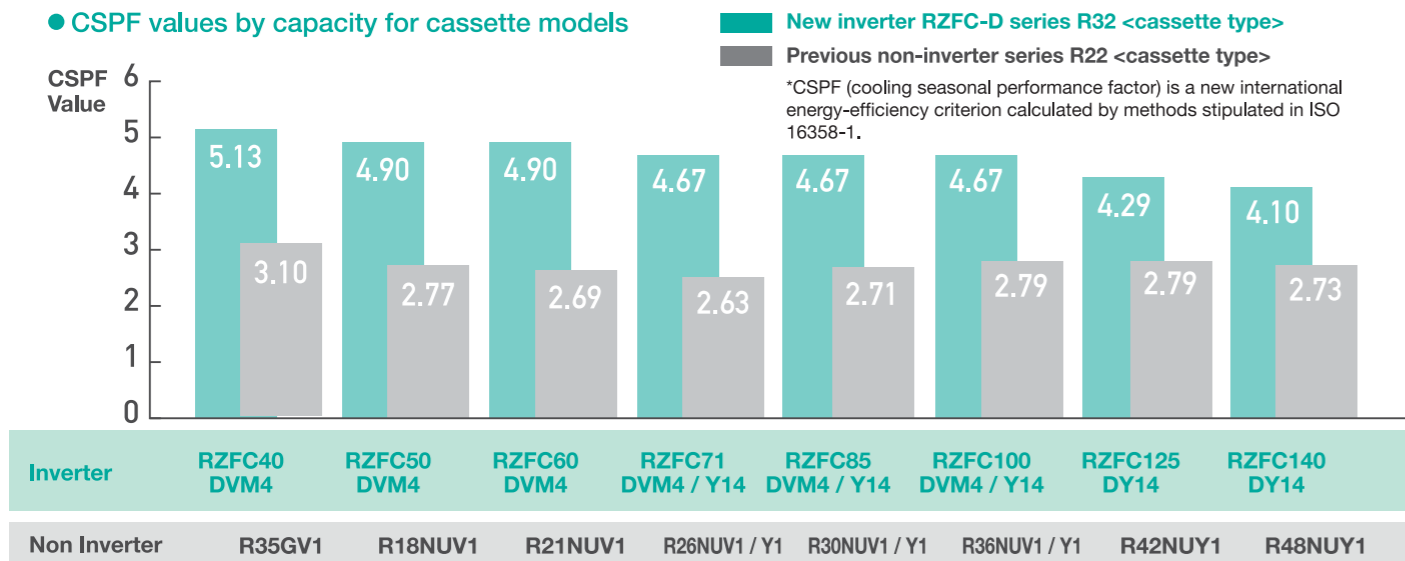

What is CSPF?

CSPF is the value for the annual total cooling load divided by the annual total power consumption at outdoor air conditions specified by ISO standard.

Benefits of Inverters

Why is inverter technology economical?

- Inverter system consumes less electricity, and soon recovers the difference in initial cost. This results in lower total cost.

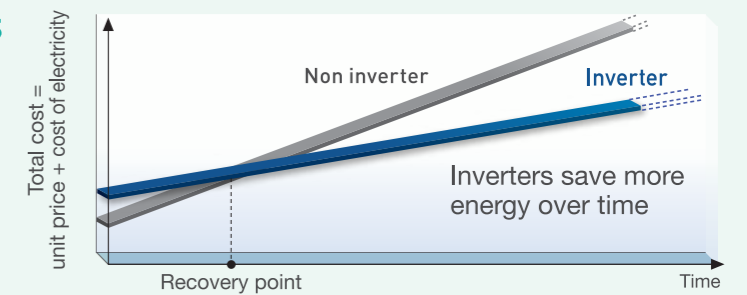

- Inverter air conditioner can adjust its cooling capacity according to the cooling load. This results in less power consumption.

In response to fluctuating cooling load, Non inverter air conditioners repeatedly perform ON (full-power)/OFF (zero-power) operation. Inverter air conditioners, however, operate at optimal cooling capacity according to the cooling load. Since inverter air conditioners provide required minimum cooling capacity with minimum electrical power, total power consumption can be reduced during cooling period.

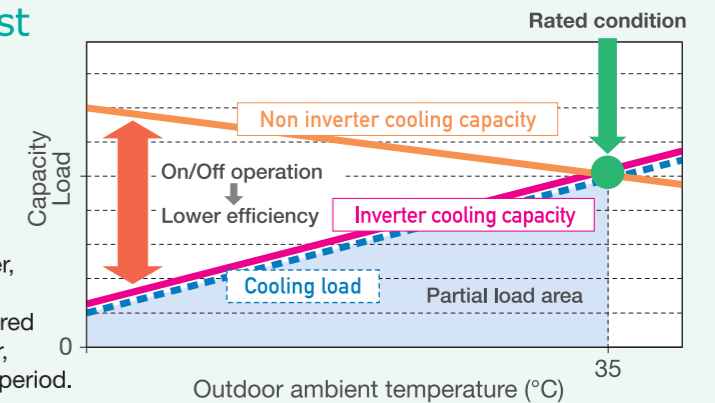

- Inverters operate without repeated ON/OFF operation.

Inverter Highway driving

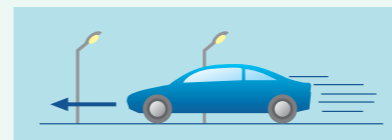

Continuous driving without stopping and starting is more fuel efficient.

Non inverter City driving



Constantly stopping and starting consumes energy and is less fuel efficient.

Why is inverter technology more comfortable?

- When temperature does not fluctuate much, the set temperature is maintained.

Inverter control responds to load changes and causes minor temperature adjustments. Non-inverter control frequently turns ON and OFF in response to load fluctuations or load mismatch and causes large temperature swings.

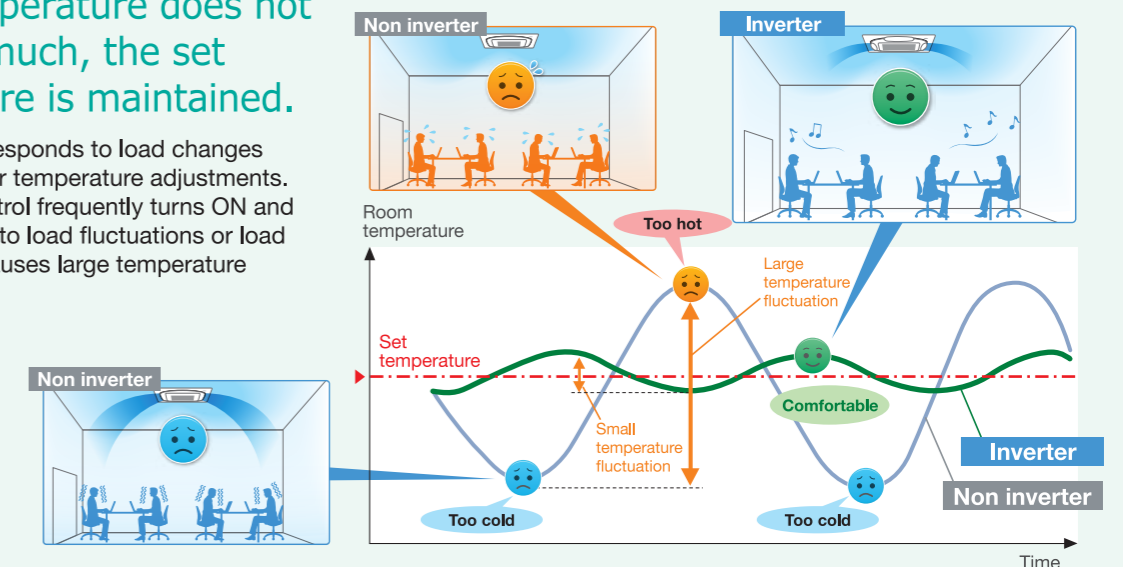

Durability

Microchannel heat exchanger (RZFC40-140)

Microchannel technology utilises superior heat transfer benefits of aluminium to create a more efficient air conditioner. With a new resistance corrosion aluminium alloy, the Daikin microchannel heat exchanger becomes highly durable. A salt spray test has been conducted to demonstrate the corrosion-resistant capability of our products in corrosive environments for a certain period of time.

Test of durability

- Testing organization MTEC Thailand
- Testing standard ASTM B117
- Result

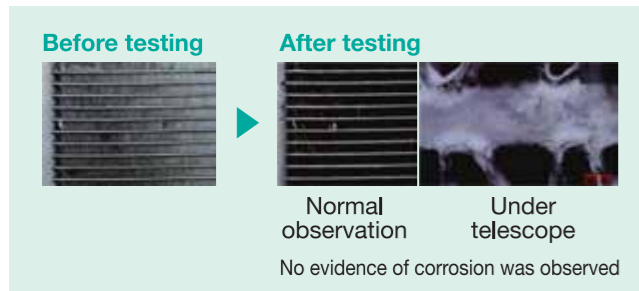

After undergoing an intensive test, the Daikin microchannel heat exchanger is able to maintain its shape without corrosion, which strongly confirms its durability in a highly corrosive environment.

Coated printed circuit boards (outdoor unit)

Coated circuit boards prevent problems caused by humidity and airborne dust. It also protects against salt contained in sea breezes. Both sides of the PCB in outdoor units are coated.



Automatic protection against low voltage

In AM and PM peak electricity consumption periods, supply may fluctuate. Built-in low-voltage protection will automatically cut operations. When normal voltage is restored, operation will resume as before.

Outdoor unit installation is possible even with limited space

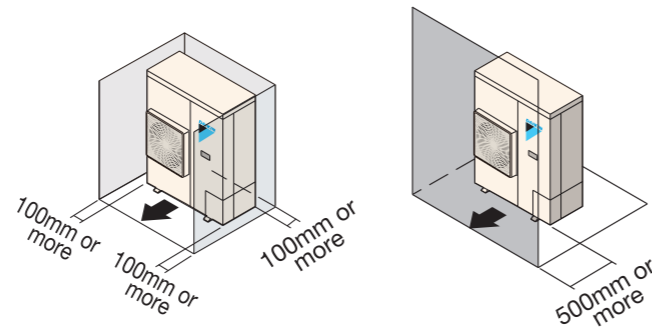

Design Flexibility

Possible to forced OFF and ON/OFF operation using external command

*Field setting with remote controller
*Except for FHFC40-85, FDBF, FDLF

Round flow cassette type

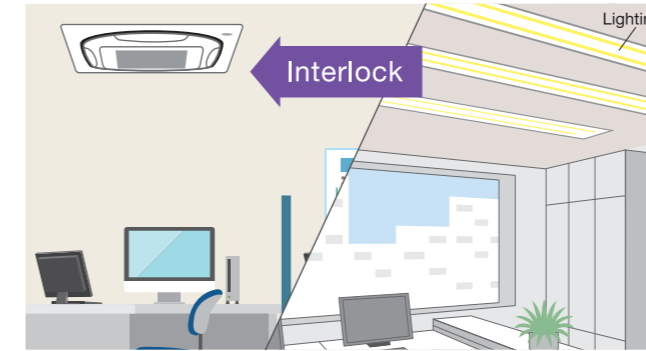

Duct connection middle static pressure type

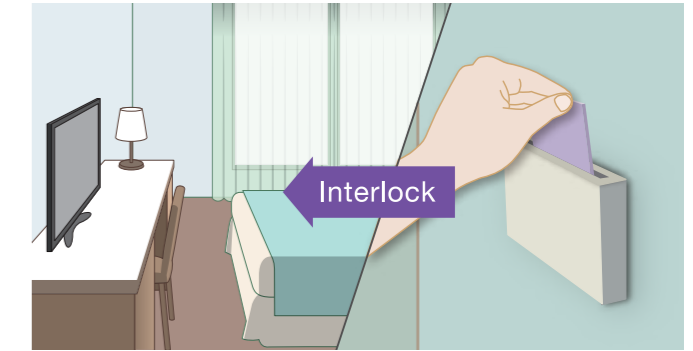

Indoor units (FCFC-D, FFFC-A, FHFC100-140D, and FBFC-D) comply with DIII-Net standards

*FHFC40-85D requires optional adaptor to connect DIII-Net.
*FDBF and FDLF cannot connect DIII-Net because they cannot use option adaptor.

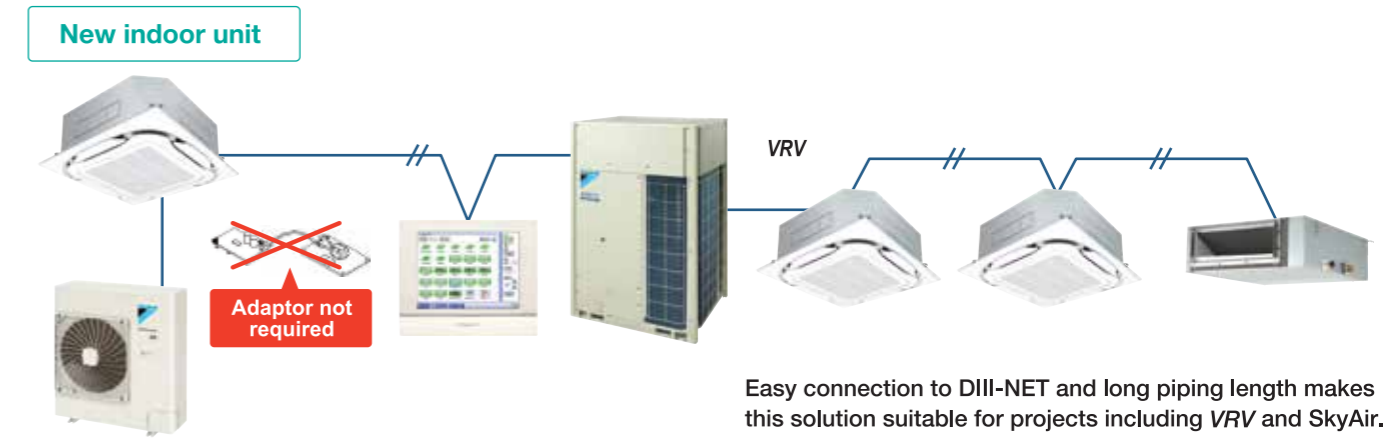

Smart Airflow Control

Indoor units can provide 3-step and 2-step fine control of air volume

3-step: FCFC, FFFC, FHFC100-140, FDBF, FDLF and FBFC series
2-step: FHFC40-85 series

Comfort ensured by 'Auto' airflow rate that matches load level

Convenient energy-efficiency for stores with peak and quiet periods.

*Except for FHFC40-85D, FDBF and FDLF

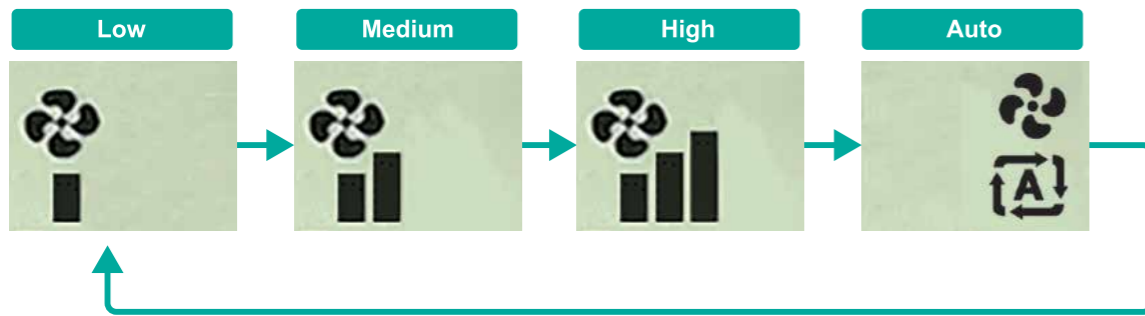
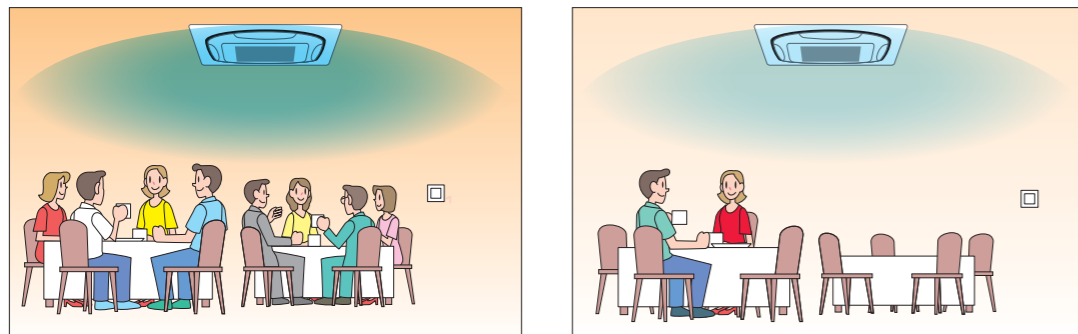

Also convenient for high ceilings and spaces with long blow distances

*Field setting with remote controller

Cassette type <Round Flow>:
maximum 4.2 m*

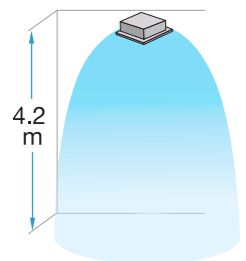

See page 13

*Maximum 4.2 m for FCFC100-140
Maximum 3.5 m for FCFC40-80

Compact multi flow
ceiling mounted cassette type:
maximum 3.5 m

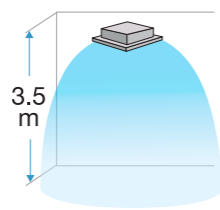

See page 18

Ceiling suspended type:
maximum 4.3 m

See page 20

*Maximum 4.3 m for FHFC100-140
Maximum 3.5 m for FHFC40-80

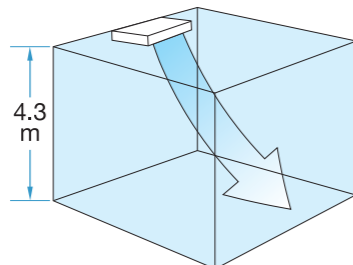

Compact & Lightweight

New outdoor units are much more compact and lighter weight

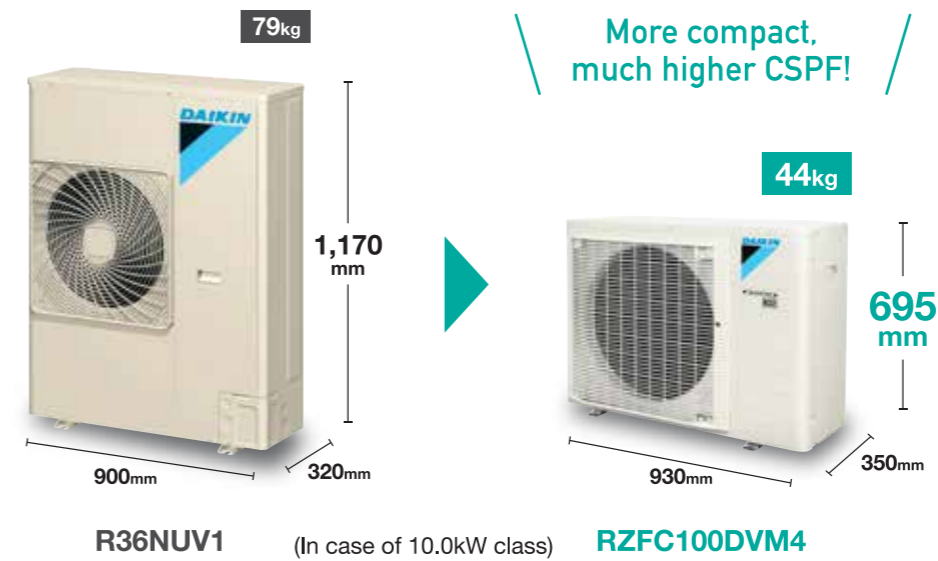

- More easy installation
- More easy transportation
- More saving space

32% reduction in volume
0.34m³ → 0.23m³

44% reduction in weight
79kg → 44kg

Comparison with the previous mainstream non-inverter series

Outdoor units are much more compact and lighter weight.
They enable easy installation in places with limited space.

	7.6 kW R26NUV1 / NUY1	8.8 kW R30NUV1 / Y1	10.6 kW R36NUV1 / NUY1	12.3 kW R42NUY1	14.1 kW R48NUY1
Previous non-inverter R-NU series	70kg 900mm x 770mm	70kg 900mm x 770mm	79kg 900mm x 1,170mm	87kg 900mm x 1,170mm	92kg 900mm x 1,345mm

	7.1 kW RZFC71DVM4	8.5 kW RZFC71DY14	10.0 kW RZFC85DVM4 / Y14	12.5 kW RZFC100DVM4 / Y14	14.0 kW RZFC125DY14	14.0 kW RZFC140DY14
New inverter RZFC-D series	37kg 845mm x 595mm	46kg 930mm x 695mm	44kg / 46kg 930mm x 695mm	44kg / 46kg 930mm x 695mm	62kg 940mm x 990mm	62kg 940mm x 990mm
Reduced by	33kg	24kg	26kg / 24kg	35kg / 33kg	25kg	30kg

Unit weight is greatly reduced.

Cassette air conditioner with 360° uniform airflow sets the standard



Option
Accessory required for indoor unit.
Simplified Remote Controller
 (Wired Remote Controller)

BRC2E61
 Note: Remote controller cable is not included and must be obtained locally.

Wireless remote controller
 A signal receiver must be added to the indoor unit.
 Cooling only
BRC7F635F

 Signal receiver unit (Installed type)
 Wireless remote controller is supplied in a set with a signal receiver.



Standard panel (Fresh white)

360° Airflow

With uniform temperature distribution



Airflow distribution creates uniform comfort throughout the space.

Room remains comfortable even when set temperature is raised 1°C.

Greater comfort

Gentle Airflow

Enhanced Comfort



360° airflow can maintain comfort even if air discharge speed is lower.

Velocity decreases by 25% when set temperature is raised 1°C to 1.5°C.

Selectable Airflow Pattern

Because air flows out from corner outlets, comfort spreads more widely.

Typical flow patterns

There are a total of 18 flow patterns.

All-round flow



(E.g., installed in middle of ceiling)

4-way flow also possible.

3-way flow



(E.g., installed near a wall)

L-shaped 2-way flow



(E.g., installed in a corner)

Opposite 2-way flow



(E.g., installed in a long room)

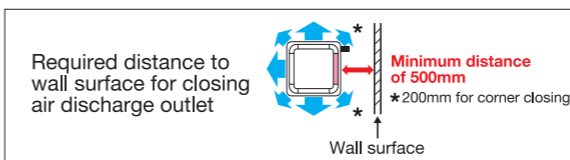

Note:
 - Whatever the discharge direction, the same type of panel is used. If installing for other than all-round flow, an air discharge outlet sealing material (option) must be used to close each unused outlet.
 - Operation sound increases when using 2-way or 3-way flow.
 - Designer panel cannot operate 2-way and 3-way flow.

New Technologies

1 Use of new wide flaps (Straight)

With new, larger flaps, a straighter trajectory for airflow was achieved.

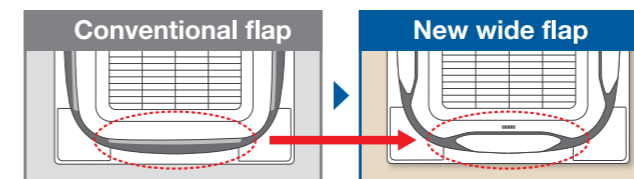

New wide flap construction inhibits ceiling dirt and grime.

By tapering both flap ends, the airflow that causes dirty ceilings is directed downward.



2 Optimizing airflow angle (Horizontally)

The airflow angle was made more horizontal.

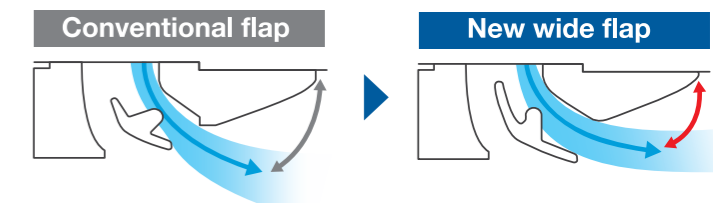

Comfort

Unified square panels

Panel size is the same for all models. It is easy to maintain a neat appearance when multiple units are installed in the same room.

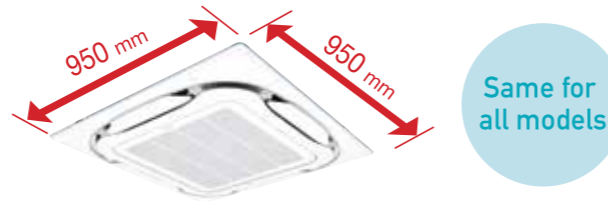

Optimal comfort and convenience assured by 3 air discharge modes

Air direction	Standard setting ¹	Draft prevention setting (field setting)	Ceiling soiling prevention setting ² (field setting)
Desired situation	For gentle drafts.	When drafts are unwanted.	For shops with light coloured ceilings that must be kept spotless.
Auto-swing			
5-level air direction setting			
Auto air direction control		The air direction is set automatically to the memorised position of the previous air direction.	

Note:
¹Air direction is set to the standard position when the unit is shipped from the factory. The position can be changed from the remote controller.
²Closing of the corner discharge outlets is recommended.

Switchable fan speed: 3 steps and Auto

Auto airflow rate is available when wired remote controller BRC2E61 is used.

Quiet operation

Indoor unit	Sound pressure level		
	H	M	L
40-60D	37	32	28
71D	37	34	28
85D	38	34	29
100D	45	38	33
125/140D	46	40	33

Suitable for high ceilings

Even in spaces with high ceilings, a comfortable airflow is carried down to the floor level.

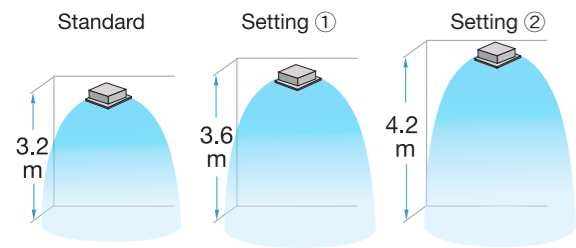

When all round flow is selected, ceilings up to 4.2 m in height can be accommodated. (100-140D)

Criteria for ceiling height and number of air discharge outlets (Ceiling height is reference value)

Ceiling height	Standard	Number of air discharge outlets used							
		40-85D				100-140D			
		All round flow	4-way flow	3-way flow	2-way flow	All round flow	4-way flow	3-way flow	2-way flow
High ceiling ①	2.7 m	3.1 m	3.0 m	3.5 m	3.2 m	3.4 m	3.6 m	4.2 m	
High ceiling ②	3.0 m	3.4 m	3.3 m	3.8 m	3.6 m	3.9 m	4.0 m	4.2 m	
High ceiling ③	3.5 m	4.0 m	3.5 m	—	4.2 m	4.5 m	4.2 m	—	

Note:
 •The aforementioned is for standard panels. See the installation manual for designer panels.
 •Factory settings are for standard ceiling height and all-round flow.
 •High ceiling settings (1) and (2) are set with the remote controller by field setting.
 •High-efficiency filters are not available for high ceiling applications.

Cleanliness

Silver ion anti-bacterial drain pan

A built-in antibacterial treatment that uses silver ion in the drain pan prevents the growth of slime, bacteria, and mould that cause odours and clogging. (The lifespan of a silver ion cartridge depends on the usage environment, but should be changed once every two to three years.)



Non-flocking flaps

Flaps can be detached without use of tools. Condensation does not easily form and dirt does not cling to non-flocking flaps. They are easy to clean.



Filter has anti-mould and antibacterial treatment

Prevents mould and microorganisms growing out of the dust and moisture that adheres to the filters.

Quick and Easy Installation

Lightweight

All models can be installed without using a lifter.

Installable in tight ceiling spaces

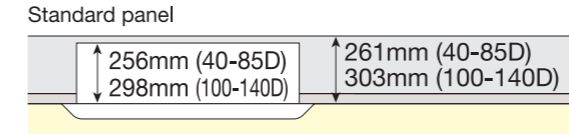

Easy height adjustment

Each corner of the unit has an adjuster pocket that lets you easily adjust the unit's suspended height.

Note:
 If the wireless remote controller is installed, a signal receiver unit is housed in one of the adjuster pockets.

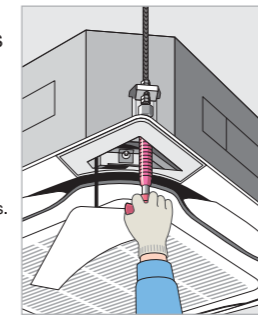

Temporary placement of control box lid

Because the control box lid can be temporarily hung on the unit, there is no need to climb down the stepladder to retrieve it.

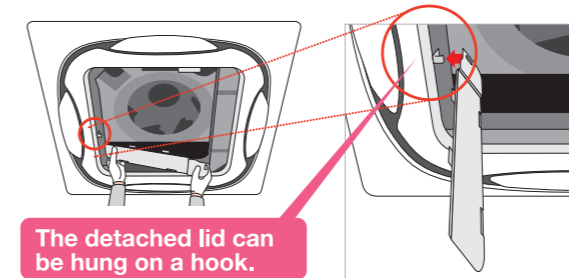

The detached lid can be hung on a hook.

Easy hanging

Washer fixing plates secure washers in place and prevent washers from falling for easy installation.



Easy removal of corner cover

It is possible to easily remove without use of screws or tools.



Ease in temporary hanging of decoration panel

In addition to the temporary hanging fixtures in 2 places normally used, corner part mounting fixtures in 4 places are provided.

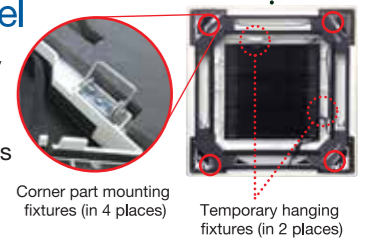

Drain pump

Equipped as standard accessory with 850 mm lift.

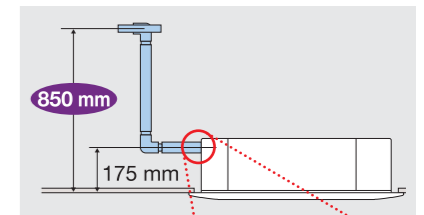

Transparent drain socket



Hanging height adjustment

Because the configuration of the hanger bracket changed, the dimensions from the ceiling to the hanger bracket also change during height adjustment for indoor unit.

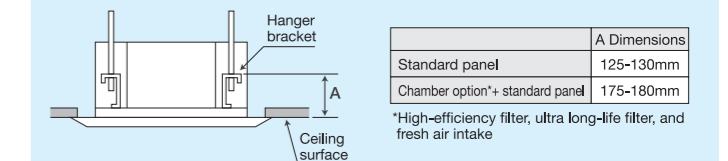

Easy Maintenance

Condition of the drain pan and drain water

Note: For inquiries concerning auto grille panel installations, please contact your local dealer or Daikin representative.

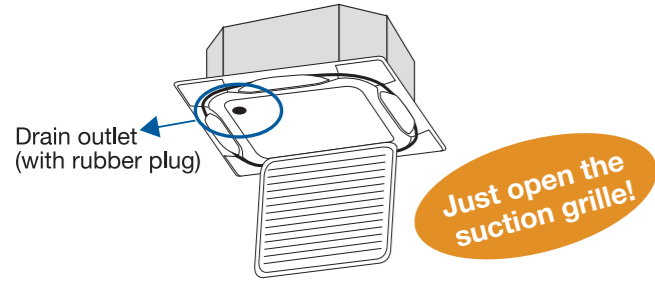

24 mm diameter drain outlet

The drain outlet allows insertion of a finger or dental mirror for inspection of the internal cleanliness of the drain pan. Removal of the suction panel enables access.

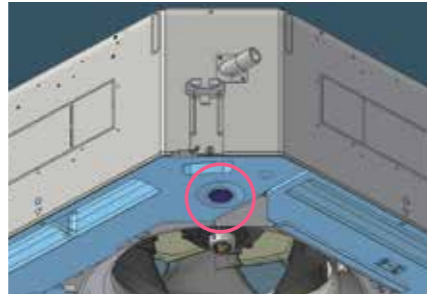

Low gas pressure detection

Insufficient gas charging is normally hard to detect. During test run after installation and regular inspection, the refrigerant level is monitored by a microprocessor to maintain proper gas pressure. Reliability is assured and maintenance and inspection can be carried out more quickly.

Ultra long-life filter (option) See page 16

Maintenance is not required in normal shops or offices for up to four years.



Options

Options required for specific operating environments

Ultra long-life filter unit

Even in dusty environments where the air conditioning is constantly operating, the ultra long-life filter only has to be cleaned once a year.

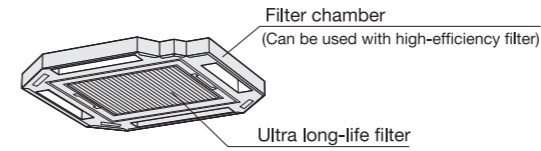

Dusty area: annual filter change

*For dust concentration of 0.3 mg/m³ (Requires separately sold Air purifier.)
1 year (Approx. 5,000 hr) ≈ 15 hr/day x 28 day/month x 12 month/year

Ordinary store or office: filter change every 4 years

*For dust concentration of 0.15 mg/m³
4 years (Approx. 10,000 hr) ≈ 8 hr/day x 25 day/month x 12 month/year x 4 years

High-efficiency filter unit

Available in two types: 65% and 90% colorimetry.

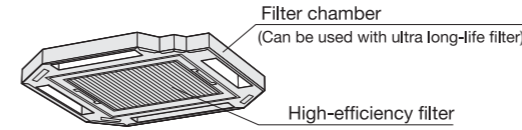

Insulation kit for high humidity

Please use if you think the temperature and humidity inside the ceiling exceeds 30°C and RH 80%, respectively.

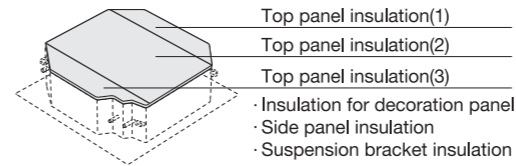

Panel spacer

Use when only minimal space is available between drop ceilings and ceiling slabs.

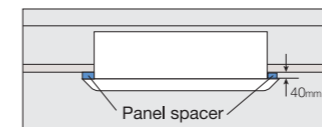

Note: Some ceiling constructions may hinder installation. Contact your Daikin Dealer before installing your unit.

Sealing material of air discharge outlet

Sealing material block air discharge openings not used in 2-way or 3-way blow.

Branch duct chamber

This chamber lets you connect a round flexible duct to the air discharge opening at any time after the original installation.

Fresh air intake kit Note 1.2

Using this kit, a duct can be connected to take in outdoor air. There are two chamber types that have intake in two places: with T-duct joint and without T-duct joint.

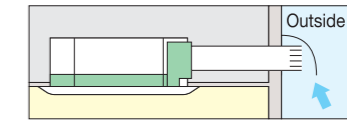

The units can be installed in the following different ways

Chamber type (without T-duct joint) Note 3.4.5

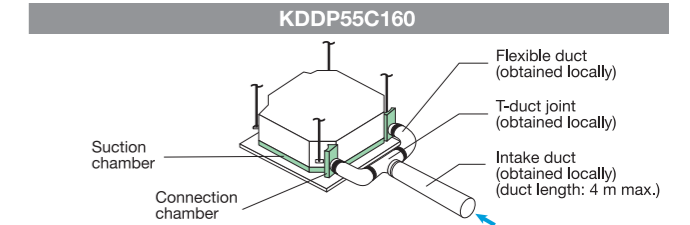

Chamber type (with T-duct joint) Note 3.4.5

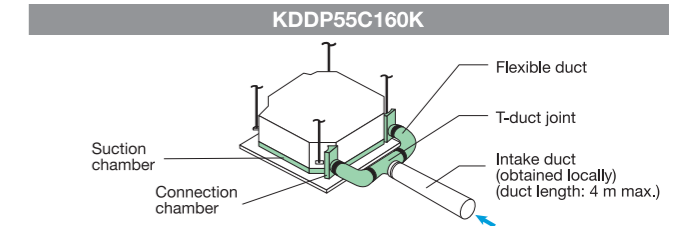

Direct installation type Note 6

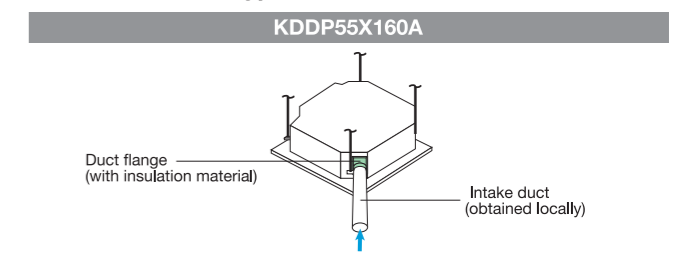

Fully flat cassette, a remarkable blend of iconic design and engineering excellence



Compact

- Sized to fit inside 600mm wide ceiling grids

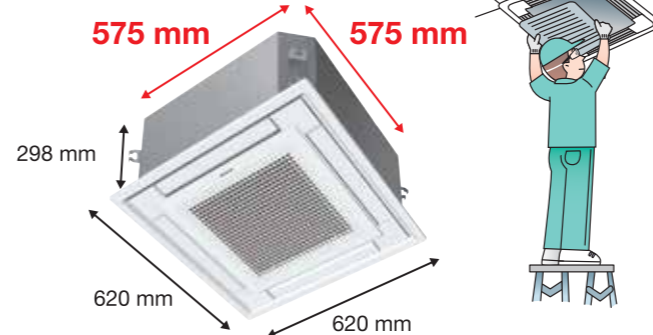

- Inspection opening is necessary on the control box and drain pump side. [See page 47](#)

Sensing technology *1, 2

*1. Applicable when BRC1E63 is used.
*2. Applicable when optional sensor kit (BRYQ60AAW) is used.

- Dual sensors (Option)

- An optional presence and floor sensor kit can be fitted to the cassette for draft prevention, energy-saving operation, and to provide optimal control of airflow.



- Direct air, Draft prevention (default: OFF)

- When human presence is detected, air direction is set to "Swing (narrow)" to deliver cool air to users, or drafts are prevented by making the flap horizontal.

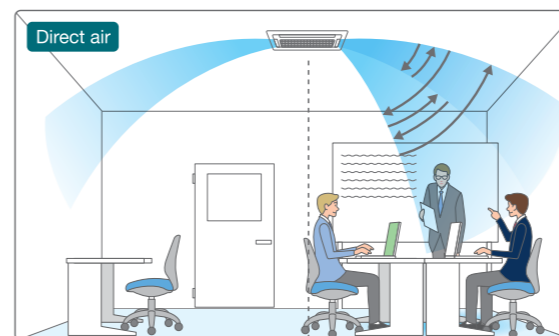

Optimal air direction by "Auto" Swing (narrow)

- Sensing sensor low / stop mode (default: OFF)

- When there are no people in a room, the set temperature is shifted or the system stops automatically for energy saving.

Individual airflow direction control *1

*1. Applicable when BRC1E63 is used.

- Airflow direction can be individually adjusted for each air discharge outlet to deliver optimal air distribution.

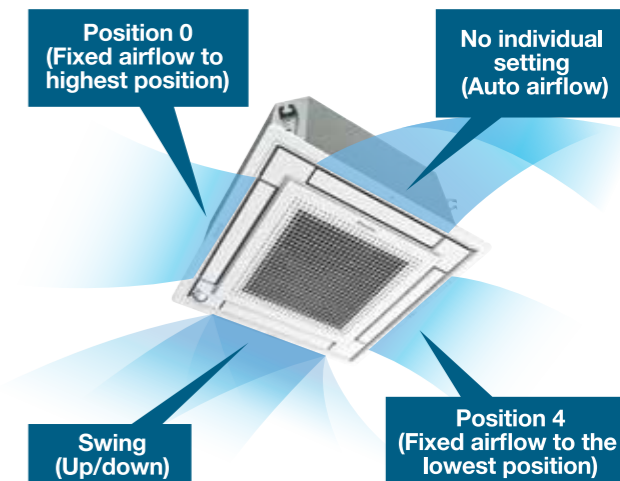

Comfort

- Fan speed: 3 steps and Auto

- Suitable for high ceilings

Even in spaces with high ceilings, a comfortable airflow is carried down to the floor level.

*Field setting with remote controller.

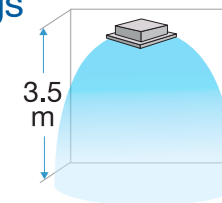

- Optimal comfort and convenience

	Auto-swing	5-levels air direction setting
Standard setting		
Draft prevention setting (Field setting)		
Setting to prevent soiling of ceiling (Field setting)		

- Selectable airflow pattern

4-way flow	3-way flow	2-way flow

■ Drain socket □ Piping ■ Sealing material (Option)

*For 3-way or 2-way flow, the sealing material of air discharge outlet (option) must be used.
*Field setting with remote controller.

Fully Flat with the Ceiling

- Fully-flat integration in standard architectural ceiling tiles, leaving only 8 mm.

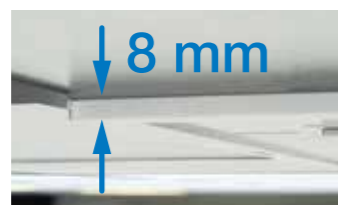

Fits Architectural Ceiling Tiles Perfectly

- The newly designed panel integrates fully within one ceiling tile enabling lights, speakers and sprinklers to be installed in the adjoining ceiling tiles.



Unobtrusive cassette

Option

Accessory required for indoor unit.

Navigation Remote Controller

(Wired Remote Controller)



BRC1E63

Note: Remote controller cable is not included and must be obtained locally.

Simplified Remote Controller

(Wired Remote Controller)



BRC2E61

Note: Remote controller cable is not included and must be obtained locally.

Wireless remote controller

A signal receiver must be added to the indoor unit.



Cooling only BRC7M531W



Signal receiver unit (Installed type)
Wireless remote controller is supplied in a set with a signal receiver.

Comfortable airflow travels throughout the room



FHFC40/50/60/71/85DV14



FHFC100/125/140DV14



Option

Accessory required for indoor unit.

Simplified Remote Controller

(Wired Remote Controller)



BRC2E61

Note: Remote controller cable is not included and must be obtained locally.

Wireless remote controller

A signal receiver must be added to the indoor unit.



• FHFC40-85D
Cooling only
BRC7EA66



Signal receiver unit (Installed type)
Wireless remote controller is supplied in a set with a signal receiver.

• FHFC100-140D
Cooling only
BRC7GA56



Signal receiver unit (Installed type)
Wireless remote controller is supplied in a set with a signal receiver.

Stylish Model

- ◆ Sophisticated design
Flap neatly closes when not in use. (100-140 class)
- ◆ White colour



Comfort

- ◆ The technology of the DC fan motor (100-140 class), wide sirocco fan, and large heat exchanger combine for greater airflow and quiet operation
- ◆ Auto swing (up and down) and louvers (left and right by hand) bring comfort to the room
- ◆ Louver manually adjusts for straight or wide angle airflow

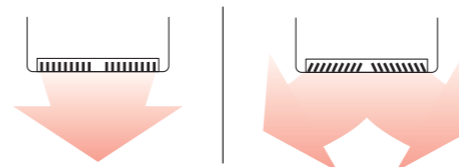

- ◆ Suitable for high ceilings

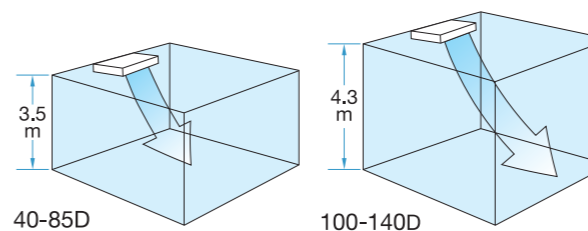

	40-85D	100D	125/140D
Standard	2.7m or less	3.8m or less	4.3m or less
High ceiling	2.7m-3.5m	3.8m-4.3m	—

Note: Factory settings is "standard".
"High ceiling" are set with remote controller by field setting.

- ◆ Switchable fan speed:
2 steps (40-85 class)
3 steps and Auto (100-140 class)
Auto airflow rate is available when wired remote controller BRC2E61 is used.

Installation Flexibility for Freedom of Design

- ◆ Flexible installation
The unit fits more snugly into tight spaces.

*Water used in the test-run can be drained from the air discharge opening rather than from the side as was formerly the case.
- ◆ Drain pump kit (option) can be easily incorporated
Drain pipe connection can be done inside the unit. Refrigerant and drain pipe outlets are at the same opening.

Drain pump kit (built inside the unit)
- ◆ DIII-NET communication standard (100-140 class)
40-85 class requires an optional adaptor.
- ◆ All wiring and internal servicing can be done from under the unit
- ◆ The rear side removable frame allows ease of access for piping work (100-140 class)

Easy Maintenance

- ◆ Drain pump kit (option) includes a silver ion antibacterial agent
That assists in preventing the growth of slime, bacteria, and mould that cause odours and clogging.
- ◆ Non-flocking flap
Condensation does not easily form and dirt does not cling to non-flocking flap. It is easy to clean.

Non-flocking flap
- ◆ Easy-clean, flat surfaces
It is easy to wipe dirt off the flat side and lower surfaces of the unit.

Oil Resistant Grille

- ◆ Oil-resistant plastic is used for the air suction grille.
This satisfies durability in restaurants and other similar environments.
Note: Intended for use in salons, dining rooms, and ordinary sales floors, this specification is not suitable for kitchens or other harsh environments.

Perfect for narrow entranceways



FDBF40/50/60/71/85DV14



Option

Accessory required for indoor unit.

Simplified Remote Controller

(Wired Remote Controller)



BRC2E61

Note: Remote controller cable is not included and must be obtained locally.

Wireless remote controller

A signal receiver must be added to the indoor unit.



Cooling only **BRC4C66**



Signal receiver unit
(Separate type)

Wireless remote controller is supplied in a set with a signal receiver.

Width compact type
700 mm

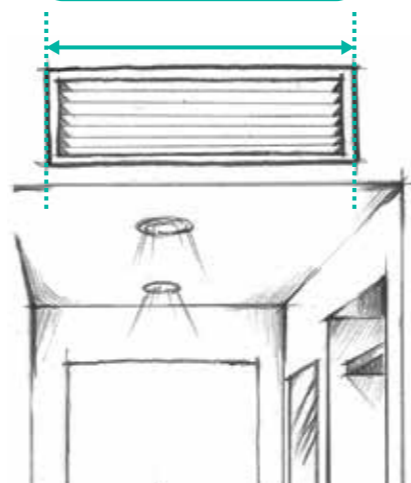

Design and Installation Flexibility

Only 700 mm width

Installation is possible even in narrow entrance ways at hotels and condominiums.

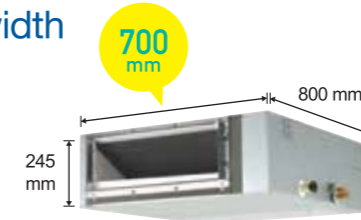

Indoor unit	FDBF40/50/60D	FDBF71/85D
Height	245 mm	
Width	700 mm	1,000 mm
Depth	800 mm	
Weight	26 kg	36 kg



Comfort

Switchable fan speed: 3 steps

Quiet Operation

25dB(A) in L tap for 40-60 class.
Operation sound is as quiet as a whisper.

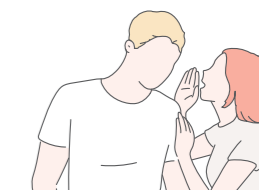

Mirror Pipe

*New features for both FDBF and FDLF series.

Enables selection of right or left piping at installation site

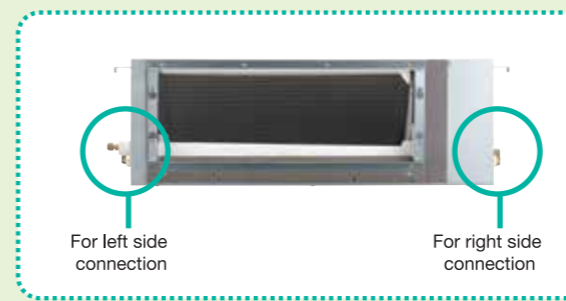

Can select!

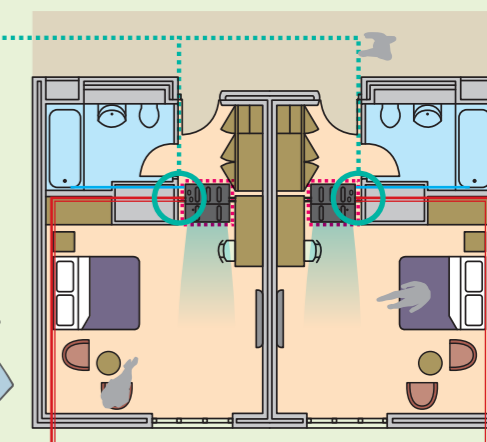

Enables high-ceiling design



FDLF40/50/60/71/85DV14



Option

Accessory required for indoor unit.

Simplified Remote Controller

(Wired Remote Controller)



BRC2E61

Note: Remote controller cable is not included and must be obtained locally.

Wireless remote controller

A signal receiver must be added to the indoor unit.



Cooling only **BRC4C66**

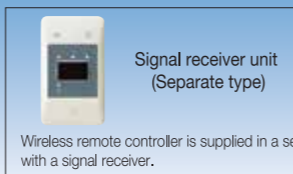

Wireless remote controller is supplied in a set with a signal receiver.

Height compact type
200 mm

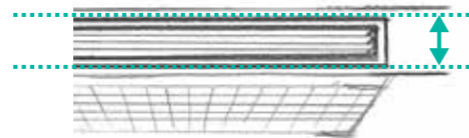

Compact and Slim Design

Only 200 mm high

Easily installed in even shallow ceiling space.

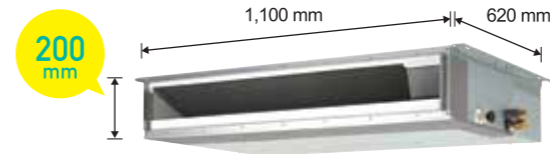

Indoor unit	FDLF40/50/60D	FDLF71/85D
Height	200 mm	
Width	900 mm	1,100 mm
Depth	620 mm	
Weight	28 kg	31 kg

Comfort

Switchable fan speed: 3 steps

Bulkhead Installation

The slim duct type can be hidden inside the ceiling to provide a clean exterior. It is suitable for living rooms with shallow tray ceilings or areas requiring a discreet appearance.

FDLF series are 900 and 1,100 mm wide, making them ideal for narrow spaces.

All models are 200 mm high and require a space of only 240 mm between the drop ceiling and ceiling slab. With these compact measurements, any unit can easily be installed in even shallow tray ceilings.



Air outlet
Air inlet and suction grille (parts obtained locally)

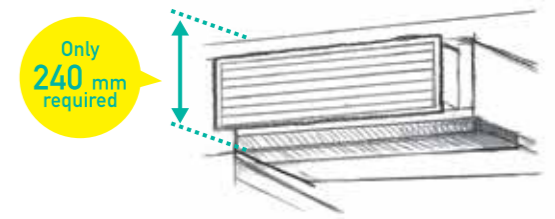

Only 240 mm required

Easy Maintenance

*New features for both FDBF and FDLF series.

1-stop service space

Owners save spaces for services

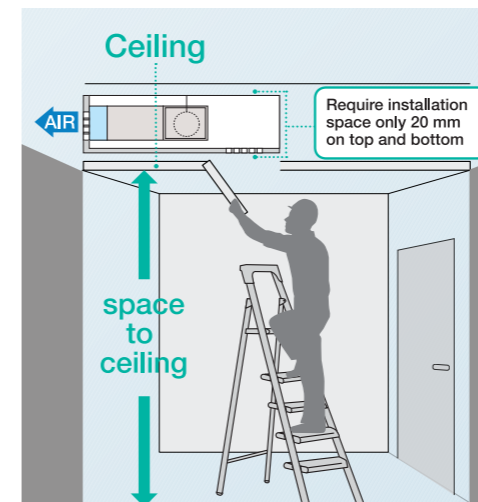

Thin design

Require limited space for installation and service



Easier and faster cleaning

Current
Need to be removed by orderly

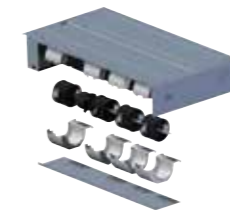

New
The integrated fan motor can be removed and reinstalled in one time



Easy access to Control box from bottom side

Current
Need space area inside for maintenance Control box

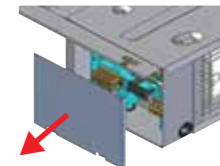

New
All wiring and maintenance can be done from bottom side

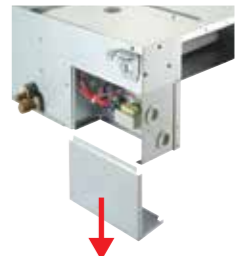

Middle static type allows greater flexibility



FBFC40/50/60/71/85/
100/125/140DVM4



Option

Accessory required for indoor unit.

Simplified Remote Controller

(Wired Remote Controller)



BRC2E61

Note: Remote controller cable is not included and must be obtained locally.

Wireless remote controller

A signal receiver must be added to the indoor unit.



Cooling only BRC4C66



Signal receiver unit (Separate type)

Wireless remote controller is supplied in a set with a signal receiver.

Simultaneous air conditioning of two rooms and ventilation grille (ventilation opening)

When air conditioning two rooms simultaneously, the air discharged into each room must be circulated back to the air conditioner. To achieve this, a ventilation duct should be installed for each room or one of the indicated ventilation grilles should be installed on the partitioning wall or under the door between the rooms.

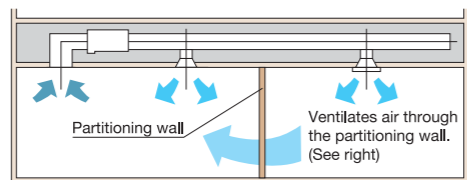

Note: The under-door cutout method should be used only when there is a small volume of airflow.

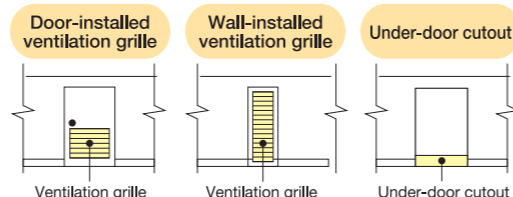

Design and Installation Flexibility

Only 245 mm high

Installation is possible even in buildings with narrow ceiling spaces.

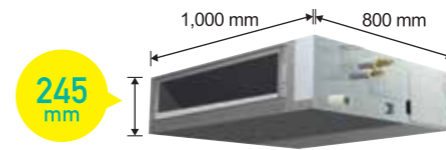

One of the industry's most compact bodies in the mid-static pressure range.

Indoor unit	FBFC40/50/60D	FBFC71/85D	FBFC100/125/140D
Height	245 mm		
Width	700 mm	1,000 mm	1,400 mm
Depth	800 mm		
Weight	26 kg	36 kg	46 kg

Bottom suction is available

Wiring and servicing can be done from the underside of the unit (an option part required).

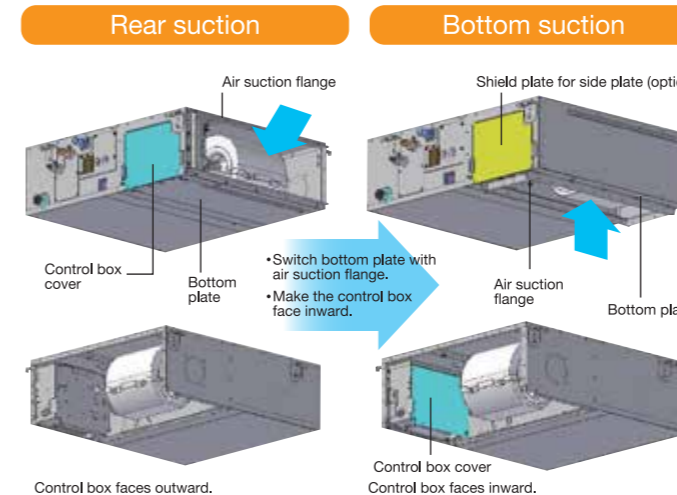
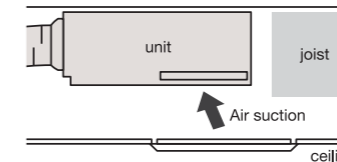

Higher lift is realized (option)

A DC drain pump with optional accessory is utilised.

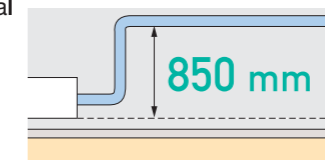

Comfort

Switchable fan speed: 3 steps and Auto

"Auto" is applicable when BRC2E61 is used.

High Efficiency

DC fan motor and DC drain pump (option)

These are utilised to improve energy efficiency.

Adjustable E.S.P.

External static pressure can be controlled to within a range of 50 Pa to 150 Pa (FBFC100-140)* by using a DC fan motor.



Set to low static pressure when ducts are short.

Set to high static pressure for advanced needs such as when using dampers and long ducts.

Comfort airflow is achieved in accordance with conditions such as duct length.

*30-130 Pa for FBFC40-60, 40-140 Pa for FBFC71/85

Airflow rate auto adjustment function

Controls the airflow rate using a remote controller during test run. It is automatically adjusted to approximately ±10% of the rated H tap airflow.

Interlock control

As an energy saving feature, the room air conditioning unit can be interlocked with the hotel key card system. Using a 3rd-party building management system, air conditioning and lighting can be interlocked.

* Field setting with remote controller



DIII-NET communication standard

Connection to a centralised control system is available without need for an optional adaptor.

Easy Maintenance

Position of drain pan inspection opening

Modified for easier inspection work.

Drain pan maintenance check window

This makes it possible to inspect for drain pan dirt and to confirm drainage during installation without the use of tools.

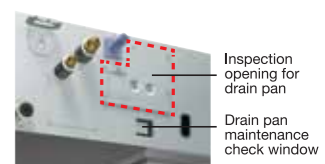

Clean

Silver ion anti-bacterial drain pan

A built-in antibacterial treatment that uses silver ion in the drain pan prevents the growth of slime, bacteria, and mould that cause odours and clogging. (The lifespan of a silver ion cartridge depends on the usage environment, but should be changed once every two to three years.)



Compact outdoor unit



Easy Installation and Maintenance

- Facilitates pump down** (Refrigerant recovery function)
 A pump-down switch is provided to make it easier to collect refrigerant if the unit is to be moved or layout modified.
- Low gas pressure detection function**
 Effective gas monitoring reduces the labor required for operation, maintenance, and repairs.

*Pump-down function is available for pre-charged refrigerant amount.
 *Although pumping-down operation allows most of the refrigerant to be recovered in a short period of time, some refrigerant will remain inside the indoor unit and refrigerant piping.
 Using a refrigerant recovery machine, recover remaining refrigerant from the stop valve service port until the pressure falls to 0.09 MPa. (gauge pressure:-0.011MPa) or less.

Technology for energy efficiency

1 Swing compressor

High efficiency during partial load operation.

Energy savings is realised, eliminating the friction and the leakage of refrigerant gas.

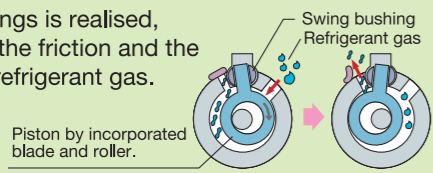

2 Refrigerant cooling

(RZFC71-140DY14)

Daikin's unique refrigerant cooling system exhibits high cooling capacity even during high outdoor temperatures.

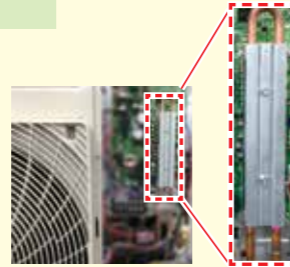

Refrigerant cooling helps protect the printed circuit board and maintains high cooling capacity even during high outdoor temperatures.

3 High efficiency by micro channel heat exchanger

(RZFC40-140)

Reduced wind resistance

The flattening of the heat exchanger tubes improves the flow of air and increases heat exchange efficiency.

Conventional tube and fin coil

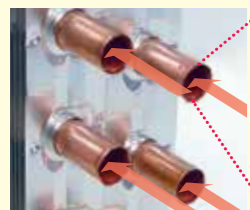

Flow of refrigerant

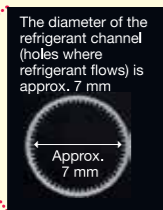

Micro channel coil

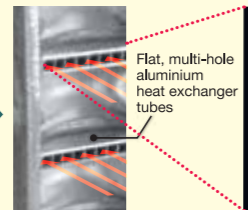

Flow of refrigerant

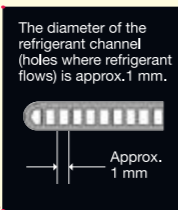

Conventional heat exchanger

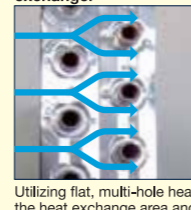

Utilizing flat, multi-hole heat exchanger tubes increases the heat exchange area and realizes energy savings.

Micro channel heat exchanger

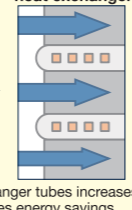

4 Fan

V-cut Propeller Fan (RZFC40-100DVM4/Y14)

Through use of a V-cut propeller fan that imitates the efficiency of the swan, a migratory bird, airflow becomes smooth and loss is reduced.



V-cut propeller fan



Imitating the performance of the swan

Simplified Remote Controller (wired)

BRC2E61



Simple operation

Using only six buttons, users have direct access to basic functions. This enables them to easily set comfort to their preference.

Compact

Measuring only 85 x 85 mm, the new remote controller is extremely compact and complements any interior design.

Intuitive design

By using pictograms, the user-friendly interface enables:

Overseas guests at hotels to understand functions without having to know a foreign language.

Children and elderly users at home to operate without having to read difficult and hard-to-see commands.

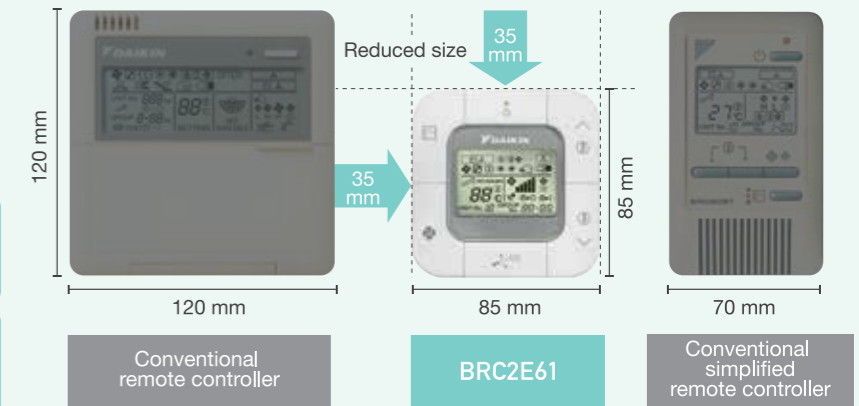

Navigation Remote Controller (Wired)

BRC1E63

Operation easy and smooth, just follow the indications on the navigation remote controller.



*FFFC series only.

Energy saving

Setpoint auto reset

- Even if the set temperature is changed, the new set temperature returns to the previous preset value after a preset duration of time.
- Period selectable from 30, 60, 90, or 120 min.

Setpoint range set

- Saves energy by limiting the min. and max. set temperature.
- Avoids excessive heating or cooling.
- This function is convenient if the remote controller is installed where anyone can change the settings.

OFF timer (programmed)

- Sets and saves setting for an increment of time that automatically turns OFF air conditioner after a preset period of time for each time operation starts.
- Period can be preset from 30 to 180 minutes in 10-minute increments.

Convenience

Weekly schedule

- 5 actions per day can be scheduled for each day of the week.
- The holiday function will disable schedule timer for the days that have been set as holiday.
- 3 independent schedules can be set. (e.g. summer, winter, mid-season)

Setback (default: OFF)

- Maintains the room temperature in a specific range during unoccupied periods by temporarily starting an air conditioner that had been turned OFF.

Wireless remote controller



BRC7F635F

Signal receiver unit (Installed type)



BRC7GA56

Signal receiver unit (Installed type)



BRC7EA66

Signal receiver unit (Installed type)



BRC4C66

Signal receiver unit (Separate type)



BRC7M531W

Signal receiver unit (Installed type)



- The wireless remote controller is supplied in a set with a signal receiver.
- Signal receiver unit of installed type is contained inside decoration panel or indoor unit.
- Shape of signal receiver unit differs according to the indoor unit.

Wireless remote controller for each indoor unit type

		Cooling only
CEILING MOUNTED CASSETTE TYPE		BRC7F635F
COMPACT MULTI FLOW CEILING MOUNTED CASSETTE TYPE		BRC7M531W
CEILING SUSPENDED TYPE	40-85	BRC7EA66
	100-140	BRC7GA56
DUCT CONNECTION LOW STATIC PRESSURE WIDTH COMPACT TYPE		BRC4C66
DUCT CONNECTION LOW STATIC PRESSURE HEIGHT COMPACT TYPE		
DUCT CONNECTION MIDDLE STATIC PRESSURE TYPE		

System variation to control multiple indoor units

	Control pattern	Wired remote controller	Wireless remote controller
Control by 1 remote controller	(Basic system)	<ul style="list-style-type: none"> ● Non-polar, double-core (max. wiring length 500 m) 	<ul style="list-style-type: none"> ● Signal receiver unit installed on indoor unit
Control by 2 remote controllers	For control from 2 locations such as in room and control room, exits, etc.	<ul style="list-style-type: none"> ● Connects 2 wired remote controllers (See note 1) 	<ul style="list-style-type: none"> ● Control by 1 wireless remote controller and 1 wired remote controller (See note 2 and 3) ● Signal receiver unit installed on indoor unit
Group control	For simultaneous control of up to 16 indoor units.	<ul style="list-style-type: none"> ● Automatic address setting function 	<ul style="list-style-type: none"> ● Automatic address setting function ● Signal receiver unit installed on 1 indoor unit
Control by external command	Operation and monitoring is carried out using the contact signal from the operation control box in the monitoring room. <small>*Except for FDBF and FDLF</small>	<ul style="list-style-type: none"> (Command from outside) ● Optional wiring adaptor for electrical appendices is necessary 	<ul style="list-style-type: none"> (Command from outside) ● Optional wiring adaptor for electrical appendices is necessary
Centralised remote control	Centralised control of up to 64 indoor groups from remote location up to 1 km away. <small>*Except for FDBF and FDLF</small>	<ul style="list-style-type: none"> Central remote controller (option) ● Interface adaptor for SkyAir series (option) is required (See note 4) 	<ul style="list-style-type: none"> Central remote controller (option) ● Interface adaptor for SkyAir series (option) is required (See note 4)
Interlock control with Heat Reclaim Ventilator	Link by remote controller group control.	<ul style="list-style-type: none"> ● Can be operated simultaneously or independently by remote controller (set by ventilation mode) 	<ul style="list-style-type: none"> ● Can be operated simultaneously by remote controller
	Zone link control by centralised control. <small>*Except for FDBF and FDLF</small>	<ul style="list-style-type: none"> Central remote controller (option) ● Heat Reclaim Ventilator for indoor units within a zone is operated by interlocking. Can also be operated independently by remote controller. 	<ul style="list-style-type: none"> Central remote controller (option) ● Heat Reclaim Ventilator for indoor units within a zone is operated by interlocking.

Note: ¹Available combinations: 1) BRC1E63 (main) and BRC1E63 (sub) 2) BRC2E61 (main) and BRC2E61 (sub) 3) BRC1E63 (main) and BRC2E61 (sub)
²When a wireless remote controller is used, it is not possible to use 2 wireless remote controllers. ³Available combinations: Please refer to table*6 on page 31.
⁴FHFC40-85D requires interface adaptor for SkyAir series. FDF, FDBF, and FDLF series cannot connect to centralised control.

Easily adaptable to large-scale, high-function, centralised remote control system.

Central remote controller	Unified on/off controller	Schedule timer	Intelligent Controller
DCS302CA61 (Option)	DCS301BA61 (Option)	DST301BA61 (Option)	DCS601C51 (Option)
Centralised control, with setting as simple as it is with a standard remote controller, of up to 64 groups (1,024 indoor units) is possible.	Centralised control of on/off by group or all at once for up to 256 indoor units.	Unified control of weekly schedule for up to 1,024 indoor units. Schedule timer sets on/off time in 1 minute units to be executed twice a day for a week at a time.	With its high functionality, the full colour "all-in-one" graphic controller facilitates management of SkyAir System in a variety of ways.
Interface adaptor for SkyAir series DTA112BA51 (Option)	Enables centralised control via connection to a high-speed, DIII-NET communication system, adopted for the Daikin V/V system. <small>Necessary for interface adaptor for SkyAir series with the central remote control units shown at above.</small>		● The interface adaptor for SkyAir series is required for Ceiling suspended type 40-85 class.

Functions overview

Cooling only

		CEILING MOUNTED CASSETTE TYPE (Round Flow)		COMPACT MULTI FLOW CEILING MOUNTED CASSETTE TYPE			
Indoor unit		FCFC40-140DVM4		FFFC35-71AVM4			
Outdoor unit		RZFC40-100DVM4 RZFC71-140DY14		RZFC35EVM4 RZFC50-71DVM4			
Remote controller	Wired	BRC2E61	----	BRC1E63	BRC2E61	----	
	Wireless	----	BRC7F635F	----	----	BRC7M531W	
Energy Saving	1	Sensing sensor stop mode		● Sensor kit			
	2	Sensing sensor low mode		● Sensor kit			
	3	Auto display OFF		●			
	4	Setpoint auto reset		●			
	5	Setpoint range set		●			
	6	OFF timer (programmed)		●			
	7	Weekly schedule timer		●			
	8	ON/OFF timer	●	●	●	●	●
Comfort	9	Setback		●			
	10	Individual airflow control		●			
	11	Infrared presence sensor			● Sensor kit		
	12	Infrared floor sensor			● Sensor kit		
	13	Auto airflow function (Direct air, Draft prevention)		● Sensor kit			
	14	Auto swing	●	●	●	●	●
	15	Swing pattern selection	●	●	●	●	●
	16	DC fan motor (Indoor unit)		●			
	17	Switchable fan speed	● 3 step	● 3 step	● 3 step	● 3 step	● 3 step
	18	Auto airflow rate	●		●		●
	19	Two selectable temperature-sensors *1	●		●		●
	20	High ceiling application	● 3.5m / 4.2m	● 3.5m / 4.2m	● 3.5 m	● 3.5 m	● 3.5 m
Cleanliness	21	Anti-bacterial air filter	●		●		
	22	Mould-proof air filter					
	23	Silver ion anti-bacterial drain pan	●				
Work & Servicing	24	Drain pump mechanism	●		●		
	25	Pre-charged for up to 10 / 15m *2	●		●		
	26	Long-life filter	●		●		
	27	Filter sign		●		●	
	28	Low gas pressure detection *2	●		●		
	29	Emergency operation		● *5		●	
	30	Self-diagnosis function	●	●	●	●	●
31	Service contact display			●			
Control	32	Auto-restart	●		●		
	33	Control by 2 remote controllers	● *6	● *6	● *6	● *6	
	34	Group control by 1 remote controller	●	●	●	●	
	35	External signal forced OFF and ON/OFF operation	●		●		
	36	External command control *3	●		●		
	37	Central remote control	●		●		
	38	Interlock control with Heat Reclaim Ventilator	●		●		
	39	DLII-NET communication standard	●		●		
	Options	40	High-efficiency filter	●			
41		Ultra long-life filter	●				
42		Fresh air intake kit	●		●		

● Possible

Note:

*1: Applicable when wired remote controller is used.

*2: For outdoor units.

*3: Wiring adaptor for electrical appendices (and installation box) is necessary.

*4: Option is required.

*5: For outdoor unit RZFC-DY14 only.

*6: Available combinations are ● in the table*6.

		Table *6		Main	
				Wired remote controller	
				BRC1E63	BRC2E61
Sub	Wired remote controller	BRC1E63		●	
		BRC2E61		●	●
Wireless remote controller		BRC4C*, BRC7C/E/F/G*			●
		BRC7M*, BRC4M*		●	●

		CEILING SUSPENDED TYPE		DUCT CONNECTION LOW STATIC PRESSURE WIDTH COMPACT TYPE		DUCT CONNECTION LOW STATIC PRESSURE HEIGHT COMPACT TYPE		DUCT CONNECTION MIDDLE STATIC PRESSURE TYPE			
		FHFC40-85DV14		FHFC100-140DV14		FDBF40-85DV14		FDLF40-85DV14		FBFC40-140DVM4	
		RZFC40-85DVM4 RZFC71/85DY14		RZFC100DVM4 RZFC100-140DY14		RZFC40-85DVM4 RZFC71/85DY14		RZFC40-85DVM4 RZFC71/85DY14		RZFC40-100DVM4 RZFC71-140DY14	
Remote controller	Wired	BRC2E61	----	BRC2E61	----	BRC2E61	----	BRC2E61	----	BRC2E61	----
	Wireless	----	BRC7EA66	----	BRC7GA56	----	BRC4C66	----	BRC4C66	----	BRC4C66
1		●	●	●	●	●	●	●	●	●	●
2											
3											
4											
5											
6											
7											
8		●	●	●	●	●	●	●	●	●	●
9											
10											
11											
12											
13											
14		●	●	●	●						
15						●					
16										●	
17		● 3 step	● 3 step	● 3 step	● 3 step	● 3 step	● 3 step	● 3 step	● 3 step	● 3 step	● 3 step
18						●				●	
19		●		●		●		●		●	
20		● 3.5m	● 3.5m	● 4.3m	● 4.3m						
21		●		●						● *4	
22								●			
23										●	
24		● *4		● *4						● *4	
25		●		●		●		●		●	
26		●		●						● *4	
27		●	●	●	●	●	●	●	●	●	●
28		●		●		●		●		●	
29		● *5		● *5		● *5		● *5		● *5	
30		●	●	●	●	●	●	●	●	●	●
31											
32		●		●		●		●		●	
33		● *6	● *6	● *6	● *6	● *6	● *6	● *6	● *6	● *6	● *6
34		●	●	●	●	●	●	●	●	●	●
35										●	
36		●		●		●		●		●	
37		● *4		●						●	
38		●		●		●		●		●	
39		● *4		●						●	
40										●	
41											
42				●							

Abundance of functions that provide comfortable air-conditioning in stores and offices

Note: Some features are only available on selected models.
See overview page for full list of features applicable to each unit.



Energy Saving

1. Sensing sensor stop mode

When the room is unoccupied, the system stops automatically.

2. Sensing sensor low mode

When the room is unoccupied, the set temperature is shifted automatically.

3. Auto display OFF

While operation is stopping, the LCD display can be turned off. It can be displayed again when any button is pressed.

4. Setpoint auto reset

Even if the set temperature is changed, the new set temperature returns to the previous preset value after a preset duration of time.

5. Setpoint range set

Saves energy by limiting the minimum and maximum set temperatures. Avoids excessive heating and cooling.

6. OFF timer (programmed)

Sets and saves setting for an increment of time that automatically turns off air conditioner after a preset period of time for each time operation starts.

7. Weekly schedule timer

Up to five operation ON/OFF settings can be programmed per day for each day of the week. Not only can the time be set for the operation ON setting, but also the temperature.

8. ON/OFF timer

Operation starts when the preset time of the ON timer elapses and stops when the preset time of the OFF timer elapses.

Comfort

9. Setback

Maintains the room temperature in a specific range during unoccupied periods by temporarily starting an air conditioner that had been turned OFF.

10. Quick start

At operation start, capacity priority operation is possible.

11. Infrared presence sensor

The sensor detects the presence of people in each of the 4 areas.

12. Infrared floor sensor

The sensor detects the floor temperature and automatically adjusts operation of the indoor unit to reduce the temperature difference between the ceiling and the floor.

13. Auto airflow function

When this function is set, airflow direction can be directed toward or away from people when human presence is detected.

14. Auto swing

Delivers comfortable air-conditioning to all areas, near to and far from the air-conditioner.

■ The air flow direction can be fixed at your desired angle by the remote controller.

15. Swing pattern selection

You can freely set air discharge settings by remote controller.

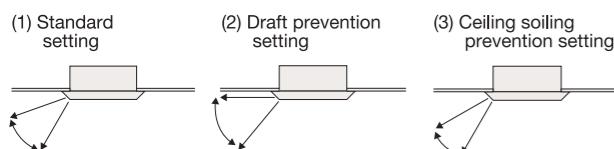

16. DC fan motor (Indoor unit)

DC fan motor improves efficiency.

17. Switchable fan speed

High setting provides maximum reach while low setting minimises drafts.

18. Auto airflow rate

Airflow rate is automatically controlled in accordance with the difference between room temperature and set temperature.

19. Two selectable temperature-sensors

Temperature-sensors are included in the indoor unit and optional wired remote controller. Temperature sensing closer to target area is possible to further increase the comfort level.

● Use the temperature-sensor in the indoor unit when controlling air conditioning from another room.

Note: Wireless remote controllers have no temperature-sensor.

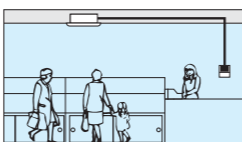

20. High ceiling application

Delivers air-conditioning comfort all the way down to the floor in air-conditioning zones with high ceilings.

Note: When units are installed on high ceilings, depending on the model, various restrictions concerning maximum height, air discharge direction, and choice of options may apply.

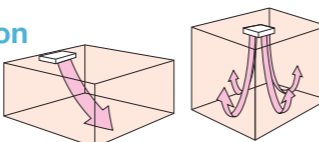

Cleanliness

21. Anti-bacterial air filter

The air filter has an anti-bacterial treatment to help prevent the growth of bacteria and mould on it.

22. Mould-proof air filter

Sanitary filter has mould-resistant treatment.

23. Silver ion anti-bacterial drain pan

A built-in antibacterial treatment that uses silver ion in the drain pan prevents the growth of slime, bacteria, and mould that cause odours and clogging.

Work & Servicing

24. Drain pump mechanism

Steeper gradient realises more efficient condensate drainage. High-lift is especially useful for long lengths of drain piping.



25. Pre-charged for up to 30 m, 10 / 15 m

If refrigerant piping length does not exceed 10 m or 15 m, there is no need for on-site gas charging.

10 m: RZFC40-71DVM4, 35EVM4
15 m: RZFC85-100DVM4, 71-140DY14

26. Long-life filter

Maintenance is not required for one year*. The filter is washable and can be reused.

*For dust concentration of 0.15 mg/m³

27. Filter sign

The filter sign warns you when it is time to clean the filter.

*When using a wired remote controller the sign is displayed in the LCD.
When using a wireless remote controller the filter sign lamp illuminates on the signal receiver unit.

28. Low gas pressure detection

Insufficient gas charging is normally hard to detect. During test run after installation and regular inspection, the refrigerant level is monitored by a microprocessor to maintain proper gas pressure. Reliability is assured and maintenance and inspection can be carried out more quickly.

29. Emergency operation

Even if there is a malfunction elsewhere in the system, the fan or compressor can still be operated. (depending on the malfunction)

30. Self-diagnosis function

The operating parameters of indoor and outdoor units, and sensor data at critical locations throughout the system, are constantly monitored using a microcomputer. To facilitate quick response in the event of a malfunction, a message appears on the LCD of the remote controller and an LED on the unit illuminates.

31. Service contact display

When installing the unit, registration of the service contact is available to the wired remote controller.

Control

32. Auto-restart

If there is a power outage while the equipment is operating, operations will restart in the same mode as before the power cut when electricity is restored.

33. Control by 2 remote controllers

Using 2 remote controllers you can operate the equipment locally or from a remote location.

*When a wireless remote controller is used, it is not possible to use 2 wireless remote controllers.

34. Group control by 1 remote controller

You can turn up to 16 indoor units ON/OFF with a single remote controller. (When using connected indoor units, the settings must all be the same and on/off will be simultaneous.)

35. External signal forced OFF and ON/OFF operation

The air conditioner can be interlocked with the keycard system and turned ON/OFF by locking and unlocking the room.

The air conditioner can be also be turned OFF by the interlock with the ventilation and lighting OFF signal.

*Field setting with remote controller.

36. External command control

Operation and monitoring is carried out using the contact signal from the operation control box in the building monitoring room.

*Wiring adaptor for electrical appendices (and installation box) is necessary.

37. Central remote control

Optional central remote controller enables centralised control of up to 1024 indoor units (64 groups) from up to 1 km away.

38. Interlock control with Heat Reclaim Ventilator

Enables interlocking control with external equipment such as Heat Reclaim Ventilator.

39. DIII-NET communication standard

Connection to a centralised control system is available without need for an optional adaptor.

Options

40. High-efficiency filter

Two types are available: 65% and 90% colorimetry.

41. Ultra long-life filter

Requires no maintenance for about 4 years* (10,000h) in stores and offices.

*For dust concentration of 0.15 mg/m³

42. Fresh air intake kit

You can provide air-conditioning with fresh air from outside. Convenient for places where a ventilation fan cannot be installed.



CEILING MOUNTED CASSETTE TYPE <Round Flow> (1 Phase)

Model Name		Indoor unit	40	50	60	71	85	100
Model Name		Outdoor unit	FCFC40DVM4	FCFC50DVM4	FCFC60DVM4	FCFC71DVM4	FCFC85DVM4	FCFC100DVM4
Model Name		Outdoor unit	RZFC40DVM4	RZFC50DVM4	RZFC60DVM4	RZFC71DVM4	RZFC85DVM4	RZFC100DVM4
Power supply		Outdoor unit	1 Phase, 220-240 V, 50 Hz					
Cooling Capacity ^{1,2} Rated (Min. - Max.)		kW	4.0 (1.8-4.5)	5.0 (2.3-5.6)	6.0 (2.6-6.3)	7.1 (3.2-8.0)	8.5 (4.2-10.0)	10.0 (5.0-11.2)
		Btu/h	13,600 (6,100-15,400)	17,100 (7,800-19,100)	20,500 (8,900-21,500)	24,200 (10,900-27,300)	29,000 (14,300-34,100)	34,100 (17,100-38,200)
Power consumption	Cooling ¹	kW	1.26	1.57	1.89	2.38	2.85	3.35
COP		kW/kW	3.18		2.98		2.90	
CSPF		kWh/kWh	5.13	4.90		4.67		
Indoor unit		Colour	White					
		Decoration panel	Fresh white					
Airflow rate (H / M / L)		m ³ /min	19 / 14 / 11		23 / 18 / 13		34 / 27 / 20	
		cfm	671 / 494 / 388		812 / 635 / 459		1,200 / 953 / 706	
Sound pressure level ³ (H / M / L)		dB(A)	37 / 32 / 28		37 / 34 / 28		38 / 34 / 29	
Dimensions (H×W×D)		Unit	256×840×840					
		Decoration panel	50×950×950		22		24	
Machine weight		kg	19		22		24	
Certified Operation range		°CWB	14 to 25					
Outdoor unit		Colour	Ivory white					
		Type	Micro channel					
Compressor		Type	Hermetically sealed swing type					
		Motor output	1.20		1.30		1.60	
Refrigerant charge (R32)		kg	0.7 (Charged for 10 m)		0.8 (Charged for 10 m)		1.0 (Charged for 15 m)	
Sound pressure level ³ Cooling		dB(A)	48	49	50	51	52	
Dimensions (H×W×D)		mm	595×845×300		695×930×350		44	
Machine weight		kg	34		37		44	
Certified Operation range		°CDB	21 to 46					
Piping connections		Liquid (Flare)	φ6.4		φ9.5		φ9.5	
		Gas (Flare)	φ12.7		φ15.9		φ15.9	
Drain		Indoor unit	VP20 (I.D. φ20×O.D. φ26)					
		Outdoor unit	φ18.0 (Hole)		φ26.0 (Hole)		φ26.0 (Hole)	
Max. interunit piping length		m	30 (Equivalent length 40)		50 (Equivalent length 70)		30	
Max. installation level difference		m	15					
Heat insulation			Both liquid and gas piping					



CEILING MOUNTED CASSETTE TYPE <Round Flow> (3 Phase)

Model Name		Indoor unit	71	85	100	125	140
Model Name		Outdoor unit	FCFC71DVM4	FCFC85DVM4	FCFC100DVM4	FCFC125DVM4	FCFC140DVM4
Model Name		Outdoor unit	RZFC71DY14	RZFC85DY14	RZFC100DY14	RZFC125DY14	RZFC140DY14
Power supply		Outdoor unit	3 Phase, 380-415V, 50Hz				
Cooling Capacity ^{1,2} Rated (Min. - Max.)		kW	7.1 (3.2-8.0)	8.5 (4.2-10.0)	10.0 (5.0-11.2)	12.5 (5.7-14.0)	14.0 (6.2-15.5)
		Btu/h	24,200 (10,900-27,300)	29,000 (14,300-34,100)	34,100 (17,100-38,200)	42,700 (19,500-47,800)	47,800 (21,200-52,900)
Power consumption	Cooling ¹	kW	2.38	2.85	3.35	4.70	5.88
COP		kW/kW	2.98		2.66		2.38
CSPF		kWh/kWh	4.67		4.29		
Indoor unit		Colour	White				
		Decoration panel	Fresh white				
Airflow rate (H / M / L)		m ³ /min	23 / 18 / 13		34 / 27 / 20		36 / 29 / 21
		cfm	812 / 635 / 459		1,200 / 953 / 706		1,271 / 1,024 / 741
Sound pressure level ³ (H / M / L)		dB(A)	37 / 34 / 28	38 / 34 / 29	45 / 38 / 33	46 / 40 / 33	
Dimensions (H×W×D)		Unit	256×840×840				298×840×840
		Decoration panel	50×950×950		24		24
Machine weight		kg	22		24		
Certified Operation range		°CWB	14 to 25				
Outdoor unit		Colour	Ivory white				
		Type	Micro channel				
Compressor		Type	Hermetically sealed swing type				
		Motor output	1.60		2.40		
Refrigerant charge (R32)		kg	1.0 (Charged for 15 m)		1.35 (Charged for 15 m)		
Sound pressure level ³ Cooling		dB(A)	50	51	52	54	56
Dimensions (H×W×D)		mm	695×930×350		990×940×320		
Machine weight		kg	46		62		
Certified Operation range		°CDB	21 to 46				
Piping connections		Liquid (Flare)	φ9.5		φ15.9		φ15.9
		Gas (Flare)	φ12.7		φ15.9		φ15.9
Drain		Indoor unit	VP20 (I.D. φ20×O.D. φ26)				
		Outdoor unit	φ18.0 (Hole)		φ26.0 (Hole)		φ26.0 (Hole)
Max. interunit piping length		m	50 (Equivalent length 70)				
Max. installation level difference		m	30				
Heat insulation			Both liquid and gas piping				

Note :
¹Rated cooling capacities are based on the following conditions: Indoor temp., 27°CDB, 19°CWB; outdoor temp. 35°CDB, 24°CWB. Equiv. refrigeration piping, 7.5 m (horizontal).
²Capacities are net, including a deduction for cooling for indoor fan motor heat.
³The operation sound is measured in anechoic chamber. If it is measured under the actual installation conditions, it is normally over the set value due to environmental noise and sound reflection.

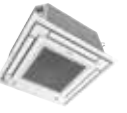

COMPACT MULTI FLOW CEILING MOUNTED CASSETTE TYPE (1 Phase)

Model Name		Indoor unit	35	50	60	71
Model Name		Outdoor unit	FFFC35AVM4	FFFC50AVM4	FFFC60AVM4	FFFC71AVM4
Model Name		Outdoor unit	RZFC35EVM4	RZFC50DVM4	RZFC60DVM4	RZFC71DVM4
Power supply		Outdoor unit	1 Phase, 220-240 V, 50 Hz			
Cooling Capacity ^{1,2} Rated (Min. - Max.)		kW	3.5 (1.3-4.0)	5.0 (2.2-5.7)	6.0 (2.5-6.4)	7.1 (2.8-8.0)
		Btu/h	11,900 (4,400-13,600)	17,100 (7,500-19,400)	20,500 (8,500-21,800)	24,200 (9,600-27,300)
Power consumption	Cooling ¹	kW	0.95	1.59	1.94	2.45
COP		kW/kW	3.70	3.15	3.10	2.90
CSPF		kWh/kWh	5.50	4.88	4.80	4.57
Indoor unit		Colour	White			
		Decoration panel	Fresh white			
Airflow rate (H/M/L)		m ³ /min	10.0 / 8.5 / 6.5	12.0 / 10.0 / 7.5	15.0 / 12.5 / 9.5	15.5 / 12.5 / 9.5
		cfm	353 / 300 / 229	424 / 353 / 265	530 / 441 / 335	547 / 441 / 335
Sound pressure level ³ (H/M/L)		dB(A)	34.0 / 30.5 / 25.0	39.0 / 34.0 / 27.0	44.0 / 40.0 / 32.0	44.5 / 40.0 / 32.0
Dimensions (H×W×D)		Unit	260×575×575 (+63) ⁴			
		Decoration panel	46×620×620			
Machine weight		kg	16	17.5		2.8
Certified Operation range		°CWB	14 to 25			
Outdoor unit		Colour	Ivory white			
		Type	Cross fin coil	Micro channel		
Compressor		Type	Hermetically sealed swing type			
		Motor output	0.80	1.20		1.30
Refrigerant charge (R32)		kg	0.73 (Charged for 10 m)	0.70 (Charged for 10 m)		0.80 (Charged for 10 m)
Sound pressure level ³ Cooling		dB(A)	48	49		50
Dimensions (H×W×D)		mm	550×675×284	595×845×300		37
Machine weight		kg	28	34		44
Certified Operation range		°CDB	21 to 46			
Piping connections		Liquid (Flare)	φ6.4		φ9.5	
		Gas (Flare)	φ9.5	φ12.7		φ15.9
Drain		Indoor unit	VP20 (I.D. φ20×O.D. φ26)			
		Outdoor unit	φ16.0 (Hole)		φ18.0 (Hole)	
Max. interunit piping length		m	20 (Equivalent length 45)		30 (Equivalent length 40)	
Max. installation level difference		m	15			
Heat insulation			Both liquid and gas piping			

Note :
¹Rated cooling capacities are based on the following conditions: Indoor temp., 27°CDB, 19°CWB; outdoor temp. 35°CDB, 24°CWB. Equiv. refrigeration piping, 5.0 m (class 35), 7.5 m (class 50-71) (horizontal).
²Capacities are net, including a deduction for cooling for indoor fan motor heat.
³The operation sound is measured in anechoic chamber. If it is measured under the actual installation conditions, it is normally over the set value due to environmental noise and sound reflection.
⁴Dimension including Electric box.



CEILING SUSPENDED TYPE (1 Phase)

		40	50	60	71	85	100
Model Name	Indoor unit	FHFC40DV14	FHFC50DV14	FHFC60DV14	FHFC71DV14	FHFC85DV14	FHFC100DV14
	Outdoor unit	RZFC40DVM4	RZFC50DVM4	RZFC60DVM4	RZFC71DVM4	RZFC85DVM4	RZFC100DVM4
Power supply	Outdoor unit	1 Phase, 220-240 V, 50 Hz					
Cooling Capacity ^{1,2} Rated (Min. - Max.)	kW	4.0 (1.8-4.5)	5.0 (2.3-5.6)	6.0 (2.6-6.3)	7.1 (3.2-8.0)	8.5 (4.2-10.0)	10.0 (5.0-11.2)
	Btu/h	13,600 (6,100-15,400)	17,100 (7,800-19,100)	20,500 (8,900-21,500)	24,200 (10,900-27,300)	29,000 (14,300-34,100)	34,100 (17,100-38,200)
Power consumption	Cooling ¹	1.33	1.67	2.00	2.50	2.99	3.52
COP		3.00		2.84		4.09	
CSPF		4.51	4.30				
Indoor unit	Colour	White					
	Airflow rate (H / M / L)	13 / - / 10		17 / - / 14		24 / - / 20	
	Sound pressure level ³ (H / M / L)	459 / - / 353		600 / - / 494		847 / - / 706	
	Dimensions (H×W×D)	195×960×680		195×1,160×680		195×1,400×680	
	Machine weight	25		27		32	
	Certified Operation range	14 to 25					
	Outdoor unit	Colour	Ivory white				
Coil		Micro channel					
Compressor		Hermetically sealed swing type					
Refrigerant charge (R32)		1.20		1.30		1.60	
Sound pressure level ³ Cooling		0.7 (Charged for 10 m)		0.8 (Charged for 10 m)		1.0 (Charged for 15 m)	
Dimensions (H×W×D)		595×845×300		695×930×350		695×930×350	
Certified Operation range		21 to 46					
Piping connections	Liquid (Flare)	φ6.4		φ9.5		φ15.9	
	Gas (Flare)	φ12.7		φ15.9		φ15.9	
	Drain	VP20 (I.D. φ20×O.D. φ26)					
Max. interunit piping length	m	30 (Equivalent length 40)			50 (Equivalent length 70)		
Max. installation level difference	m	15					
Heat insulation		Both liquid and gas piping					



CEILING SUSPENDED TYPE (3 Phase)

		71	85	100	125	140	
Model Name	Indoor unit	FHFC71DV14	FHFC85DV14	FHFC100DV14	FHFC125DV14	FHFC140DV14	
	Outdoor unit	RZFC71DY14	RZFC85DY14	RZFC100DY14	RZFC125DY14	RZFC140DY14	
Power supply	Outdoor unit	3 Phase, 380-415V, 50Hz					
Cooling Capacity ^{1,2} Rated (Min. - Max.)	kW	7.1 (3.2-8.0)	8.5 (4.2-10.0)	10.0 (5.0-11.2)	12.5 (5.7-14.0)	14.0 (6.2-15.5)	
	Btu/h	24,200 (10,900-27,300)	29,000 (14,300-34,100)	34,100 (17,100-38,200)	42,700 (19,500-47,800)	47,800 (21,200-52,900)	
Power consumption	Cooling ¹	2.50	2.99	3.52	4.88	6.07	
COP		2.84		2.56		2.31	
CSPF		4.09		3.82		3.71	
Indoor unit	Colour	White					
	Airflow rate (H / M / L)	24 / - / 20		30 / - / 25		28 / 24 / 20	
	Sound pressure level ³ (H / M / L)	847 / - / 706		1,059 / - / 883		988 / 847 / 706	
	Dimensions (H×W×D)	195×1,400×680		195×1,590×680		235×1,590×690	
	Machine weight	32		35		38	
	Certified Operation range	14 to 25					
	Outdoor unit	Colour	Ivory white				
Coil		Micro channel					
Compressor		Hermetically sealed swing type					
Refrigerant charge (R32)		1.60			2.40		
Sound pressure level ³ Cooling		1.0 (Charged for 15 m)			1.35 (Charged for 15 m)		
Dimensions (H×W×D)		695×930×350			990×940×320		
Certified Operation range		21 to 46					
Piping connections	Liquid (Flare)	φ9.5		φ15.9		φ15.9	
	Gas (Flare)	φ15.9		φ15.9		φ15.9	
	Drain	VP20 (I.D. φ20×O.D. φ26)					
Max. interunit piping length	m	50 (Equivalent length 70)			φ26.0 (Hole)		
Max. installation level difference	m	30					
Heat insulation		Both liquid and gas piping					

Note :
¹Rated cooling capacities are based on the following conditions: Indoor temp., 27°CDB, 19°CWB; outdoor temp. 35°CDB, 24°CWB. Equiv. refrigeration piping, 7.5 m (horizontal).
²Capacities are net, including a deduction for cooling for indoor fan motor heat.
³The operation sound is measured in anechoic chamber. If it is measured under the actual installation conditions, it is normally over the set value due to environmental noise and sound reflection.



DUCT CONNECTION LOW STATIC PRESSURE WIDTH COMPACT TYPE (1 Phase)

		40	50	60	71	85
Model Name	Indoor unit	FDBF40DV14	FDBF50DV14	FDBF60DV14	FDBF71DV14	FDBF85DV14
	Outdoor unit	RZFC40DVM4	RZFC50DVM4	RZFC60DVM4	RZFC71DVM4	RZFC85DVM4
Power supply	Outdoor unit	1 Phase, 220-240 V, 50 Hz				
Cooling Capacity ^{1,2} Rated (Min. - Max.)	kW	4.0 (1.8-4.5)	5.0 (2.3-5.6)	6.0 (2.6-6.3)	7.1 (3.2-8.0)	8.5 (4.2-10.0)
	Btu/h	13,600 (6,100-15,400)	17,100 (7,800-19,100)	20,500 (8,900-21,500)	24,200 (10,900-27,300)	29,000 (14,300-34,100)
Power consumption	Cooling ¹	1.19	1.56	2.07	2.37	2.98
COP		3.35		2.90		2.85
CSPF		4.38	4.13	4.13	3.93	3.93
Indoor unit	Colour	White				
	Fan	15 / 12 / 9.5		22.5 / 20 / 17.5		
	Airflow rate (H/M/L)	530 / 424 / 335		794 / 706 / 618		
	External static pressure	Pa				
	Sound pressure level ³ (H/M/L)	dB(A)				
	Air filter ⁴	Rated 15 (15-38)				
	Dimensions (H×W×D)	245×700×800		245×1,000×800		
Machine weight	26		36			
Certified Operation range	14 to 25					
Outdoor unit	Colour	Ivory white				
	Coil	Micro channel				
	Compressor	Hermetically sealed swing type				
	Refrigerant charge (R32)	1.20			1.30	
	Sound pressure level ³ Cooling	0.7 (Charged for 10 m)			0.8 (Charged for 10 m)	
	Dimensions (H×W×D)	595×845×300			695×930×350	
	Certified Operation range	21 to 46				
Piping connections	Liquid (Flare)	φ6.4		φ9.5		
	Gas (Flare)	φ12.7		φ15.9		
	Drain	VP25 (I.D. φ25×O.D. φ32)				
Max. interunit piping length	m	30 (Equivalent length 40)			50 (Equivalent length 70)	
Max. installation level difference	m	15				
Heat insulation		Both liquid and gas piping				



DUCT CONNECTION LOW STATIC PRESSURE WIDTH COMPACT TYPE (3 Phase)

		71	85
Model Name	Indoor unit	FDBF71DV14	FDBF85DV14
	Outdoor unit	RZFC71DY14	RZFC85DY14
Power supply	Outdoor unit	3 Phase, 380-415V, 50Hz	
Cooling Capacity ^{1,2} Rated (Min. - Max.)	kW	7.1 (3.2-8.0)	8.5 (4.2-10.0)
	Btu/h	24,200 (10,900-27,300)	29,000 (14,300-34,100)
Power consumption	Cooling ¹	2.37	2.98
COP		3.00	
CSPF		3.93	
Indoor unit	Colour	White	
	Fan	22.5 / 20 / 17.5	
	Airflow rate (H/M/L)	794 / 706 / 618	
	External static pressure	Pa	
	Sound pressure level ³ (H/M/L)	dB(A)	
	Air filter ⁴	Rated 15 (15-38)	
	Dimensions (H×W×D)	245×1,000×800	
Machine weight	36		
Certified Operation range	14 to 25		
Outdoor unit	Colour	Ivory white	
	Coil	Micro channel	
	Compressor	Hermetically sealed swing type	
	Refrigerant charge (R32)	1.60	
	Sound pressure level ³ Cooling	1.0 (Charged for 15 m)	
	Dimensions (H×W×D)	695×930×350	
	Certified Operation range	21 to 46	
Piping connections	Liquid (Flare)	φ9.5	
	Gas (Flare)	φ15.9	
	Drain	VP25 (I.D. φ25×O.D. φ32)	
Max. interunit piping length	m	50 (Equivalent length 70)	
Max. installation level difference	m	30	
Heat insulation		Both liquid and gas piping	

Note :
¹Rated cooling capacities are based on the following conditions: Indoor temp., 27°CDB, 19°CWB; outdoor temp. 35°CDB, 24°CWB. Equiv. refrigeration piping, 7.5 m (horizontal).
²Capacities are net, including a deduction for cooling for indoor fan motor heat.
³The operation sound is measured in anechoic chamber. If it is measured under the actual installation conditions, it is normally over the set value due to environmental noise and sound reflection.
⁴Air filter is not standard accessory, but please mount it in the duct system of the suction side. Select its dust collection efficiency (gravity method) 50% or more.

DUCT CONNECTION LOW STATIC PRESSURE HEIGHT COMPACT TYPE (1 Phase)



Model Name		40	50	60	71	85	
Indoor unit	Indoor unit	FDLF40DV14	FDLF50DV14	FDLF60DV14	FDLF71DV14	FDLF85DV14	
	Outdoor unit	RZFC40DVM4	RZFC50DVM4	RZFC60DVM4	RZFC71DVM4	RZFC85DVM4	
Power supply	Indoor unit	1 Phase, 220-240 V, 50 Hz					
Cooling Capacity ^{1,2} Rated (Min. - Max.)	kW	4.0 (1.8-4.5)	5.0 (2.3-5.6)	6.0 (2.6-6.3)	7.1 (3.2-8.0)	8.5 (4.2-10.0)	
	Btu/h	13,600 (6,100-15,400)	17,100 (7,800-19,100)	20,500 (8,900-21,500)	24,200 (10,900-27,300)	29,000 (14,300-34,100)	
Power consumption	Cooling ¹	1.19	1.56	2.07	2.37	2.98	
COP		3.35	3.20	2.90	3.00	2.85	
CSPF		4.33	4.13	4.13	3.93	3.93	
Indoor unit	Colour		Ivory white			Ivory white	
	Fan	Airflow rate (H/M/L)	16 / 14 / 12			20 / 18 / 16.5	
		External static pressure	565 / 494 / 424			706 / 635 / 582	
	Sound pressure level ³ (H/M/L)		37 / 33 / 30			40 / 37 / 34	
	Air filter		Mould-proof air filter (Removable / Washable / Mould proof)				
	Dimensions (H×W×D)		200×900×620			200×1,100×620	
	Machine weight		28			31	
	Certified Operation range		14 to 25				
	Coil		Micro channel				
	Compressor		Hermetically sealed swing type				
Refrigerant charge (R32)		0.7 (Charged for 10 m)			1.0 (Charged for 15 m)		
Sound pressure level ³	Cooling	48	49	50	51	51	
	Dimensions (H×W×D)	595×845×300			695×930×350		
Machine weight		34			44		
Certified Operation range		21 to 46					
Piping connections	Liquid (Flare)	φ6.4			φ9.5		
	Gas (Flare)	φ12.7			φ15.9		
	Drain	VP25 (I.D. φ25×O.D. φ32)					
Max. interunit piping length		30 (Equivalent length 40)			50 (Equivalent length 70)		
Max. installation level difference		15			30		
Heat insulation		Both liquid and gas piping					

DUCT CONNECTION MIDDLE STATIC PRESSURE TYPE (1 Phase)



Model Name		40	50	60	71	85	100
Indoor unit	Indoor unit	FBFC40DVM4	FBFC50DVM4	FBFC60DVM4	FBFC71DVM4	FBFC85DVM4	FBFC100DVM4
	Outdoor unit	RZFC40DVM4	RZFC50DVM4	RZFC60DVM4	RZFC71DVM4	RZFC85DVM4	RZFC100DVM4
Power supply	Indoor unit	1 Phase, 220-240 V, 50 Hz					
Cooling Capacity ^{1,2} Rated (Min. - Max.)	kW	4.0 (1.8-4.5)	5.0 (2.3-5.6)	6.0 (2.6-6.3)	7.1 (3.2-8.0)	8.5 (4.2-10.0)	10.0 (5.0-11.2)
	Btu/h	13,600 (6,100-15,400)	17,000 (7,800-19,100)	20,500 (8,900-21,500)	24,200 (10,900-27,300)	29,000 (14,300-34,100)	34,100 (17,100-38,200)
Power consumption	Cooling ¹	1.19	1.56	2.07	2.37	2.74	3.17
COP		3.35	3.20	2.90	3.00	3.10	3.15
CSPF		4.38	4.18	4.18	3.98	3.98	3.98
Indoor unit	Colour		Ivory white			Ivory white	
	Fan	Airflow rate (H/M/L)	15.5 / 12 / 9			25 / 20 / 16.5	
		External static pressure	547 / 424 / 318			883 / 706 / 582	
	Sound pressure level ³ (H/M/L)		37 / 35 / 30			39 / 37 / 34	
	Air filter ⁵		Mould-proof air filter (Removable / Washable / Mould proof)				
	Dimensions (H×W×D)		245×700×800			245×1,000×800	
	Machine weight		26			36	
	Certified Operation range		14 to 25				
	Coil		Micro channel				
	Compressor		Hermetically sealed swing type				
Refrigerant charge (R32)		0.7 (Charged for 10 m)			1.0 (Charged for 15 m)		
Sound pressure level ³	Cooling	48	49	50	51	52	
	Dimensions (H×W×D)	595×845×300			695×930×350		
Machine weight		34			44		
Certified Operation range		21 to 46					
Piping connections	Liquid (Flare)	φ6.4			φ9.5		
	Gas (Flare)	φ12.7			φ15.9		
	Drain	VP25 (I.D. φ25×O.D. φ32)					
Max. interunit piping length		30 (Equivalent length 40)			50 (Equivalent length 70)		
Max. installation level difference		15			30		
Heat insulation		Both liquid and gas piping					

DUCT CONNECTION LOW STATIC PRESSURE HEIGHT COMPACT TYPE (3 Phase)



Model Name		71	85	
Indoor unit	Indoor unit	FDLF71DV14	FDLF85DV14	
	Outdoor unit	RZFC71DY14	RZFC85DY14	
Power supply	Indoor unit	3 Phase, 380-415V, 50Hz		
Cooling Capacity ^{1,2} Rated (Min. - Max.)	kW	7.1 (3.2-8.0)	8.5 (4.2-10.0)	
	Btu/h	24,200 (10,900-27,300)	29,000 (14,300-34,100)	
Power consumption	Cooling ¹	2.37	2.98	
COP		3.00	2.85	
CSPF		3.93	3.93	
Indoor unit	Colour		Ivory white	
	Fan	Airflow rate (H/M/L)	20 / 18 / 16.5	
		External static pressure	706 / 635 / 582	
	Sound pressure level ³ (H/M/L)		40 / 37 / 34	
	Air filter		Mould-proof air filter (Removable / Washable / Mould proof)	
	Dimensions (H×W×D)		200×1,100×620	
	Machine weight		31	
	Certified Operation range		14 to 25	
	Coil		Micro channel	
	Compressor		Hermetically sealed swing type	
Refrigerant charge (R32)		1.0 (Charged for 15 m)		
Sound pressure level ³	Cooling	50	51	
	Dimensions (H×W×D)	695×930×350		
Machine weight		46		
Certified Operation range		21 to 46		
Piping connections	Liquid (Flare)	φ9.5		
	Gas (Flare)	φ15.9		
	Drain	VP25 (I.D. φ25×O.D. φ32)		
Max. interunit piping length		50 (Equivalent length 70)		
Max. installation level difference		30		
Heat insulation		Both liquid and gas piping		

DUCT CONNECTION MIDDLE STATIC PRESSURE TYPE (3 Phase)



Model Name		71	85	100	125	140	
Indoor unit	Indoor unit	FBFC71DVM4	FBFC85DVM4	FBFC100DVM4	FBFC125DVM4	FBFC140DVM4	
	Outdoor unit	RZFC71DY14	RZFC85DY14	RZFC100DY14	RZFC125DY14	RZFC140DY14	
Power supply	Indoor unit	3 Phase, 380-415V, 50Hz					
Cooling Capacity ^{1,2} Rated (Min. - Max.)	kW	7.1 (3.2-8.0)	8.5 (4.2-10.0)	10.0 (5.0-11.2)	12.5 (5.7-14.0)	14.0 (6.2-15.5)	
	Btu/h	24,200 (10,900-27,300)	29,000 (14,300-34,100)	34,100 (17,100-38,200)	42,700 (19,500-47,800)	47,800 (21,200-52,900)	
Power consumption	Cooling ¹	2.37	2.74	3.17	5.21	6.22	
COP		3.00	3.10	3.15	2.40	2.25	
CSPF		3.98	3.98	3.98	3.71	3.60	
Indoor unit	Colour		Ivory white			Ivory white	
	Fan	Airflow rate (H/M/L)	25 / 20 / 16.5			36 / 30.5 / 25	
		External static pressure	883 / 706 / 582			1,271 / 1,077 / 883	
	Sound pressure level ³ (H/M/L)		39 / 37 / 34			40 / 37.5 / 35	
	Air filter ⁵		Mould-proof air filter (Removable / Washable / Mould proof)				
	Dimensions (H×W×D)		245×1,000×800			245×1,400×800	
	Machine weight		36			46	
	Certified Operation range		14 to 25				
	Coil		Micro channel				
	Compressor		Hermetically sealed swing type				
Refrigerant charge (R32)		1.0 (Charged for 15 m)			1.35 (Charged for 15 m)		
Sound pressure level ³	Cooling	50	51	52	54	56	
	Dimensions (H×W×D)	695×930×350			990×940×320		
Machine weight		46			62		
Certified Operation range		21 to 46					
Piping connections	Liquid (Flare)	φ9.5			φ15.9		
	Gas (Flare)	φ15.9			φ26.0		
	Drain	VP25 (I.D. φ25×O.D. φ32)					
Max. interunit piping length		30 (Equivalent length 40)			50 (Equivalent length 70)		
Max. installation level difference		15			30		
Heat insulation		Both liquid and gas piping					

Note:
¹Rated cooling capacities are based on the following conditions: Indoor temp., 27°CDB, 19°CWB; outdoor temp. 35°CDB, 24°CWB. Equiv. refrigeration piping, 7.5 m (horizontal)
²Capacities are net, including a deduction for cooling for indoor fan motor heat.
³The operation sound is measured in anechoic chamber. If it is measured under the actual installation conditions, it is normally over the set value due to environmental noise and sound reflection.

Note:
¹Rated cooling capacities are based on the following conditions: Indoor temp., 27°CDB, 19°CWB; outdoor temp. 35°CDB, 24°CWB. Equiv. refrigeration piping, 7.5 m (horizontal)
²Capacities are net, including a deduction for cooling for indoor fan motor heat.
³External static pressure is changeable in 11 stages by remote controller.
⁴The operation sound is measured in anechoic chamber. If it is measured under the actual installation conditions, it is normally over the set value due to environmental noise and sound reflection.
⁵Air filter is not standard accessory, but please mount it in the duct system of the suction side. Select its dust collection efficiency (gravity method) 50% or more.

Indoor unit

CEILING MOUNTED CASSETTE TYPE <Round Flow>



No.	Name of option	Remark	Kit name		
			FCFC40DVM4 FCFC50DVM4 FCFC60DVM4	FCFC71DVM4 FCFC85DVM4	FCFC100DVM4 FCFC125DVM4 FCFC140DVM4
1	Decoration panel Standard panel	Fresh white	BYCQ125EAF		
2	Sealing material of air discharge outlet	For usage of 3-, 4-way flow	KDBH551C160		
		For usage of 2-way flow	KDBH552C160		
3	Panel spacer		KDB55J160F		
4	Fresh air intake kit	Chamber type ^{1,2} Without T-duct joint	KDDP55C160 (KDDP55C160-1, KDDP55C160-2) ⁴		
		With T-duct joint	KDDP55C160K (KDDP55C160-1, KDDP55C160K2) ⁴		
		Direct installation type ³	KDDP55X160A		
5	High-efficiency filter unit (Including filter chamber)	(Colorimetric method 65%)	KAF556D80	KAF556D160	
		(Colorimetric method 90%)	KAF557D80	KAF557D160	
6	Replacement high-efficiency filter ⁵	(Colorimetric method 65%)	KAF552D80	KAF552D160	
		(Colorimetric method 90%)	KAF553D80	KAF553D160	
7	Filter chamber		KDDFP55C160		
8	Replacement long-life filter		KAF551D160		
9	Ultra long-life filter unit (Including filter chamber)		KAF555D160		
10	Replacement ultra long-life filter ⁵		KAF550D160		
11	Branch duct chamber		KDJP55C80	KDJP55C160	
12	Insulation kit for high humidity ⁶		KDTP55K80A	KDTP55K160A	
13	Remote controller	Wireless type Cooling only	BRC7F635F		
14	Simplified remote controller	Wired type ⁷	BRC2E61		
15	Central remote controller ⁸		DCS302CA61		
16	Unified ON/OFF controller ⁸		DCS301BA61		
17	Schedule timer ⁸		DST301BA61		
18	intelligent Touch Controller ⁸		DCS601C51		
19	Adaptor for wiring ⁹		BRP11B62		
20	Wiring adaptor for electrical appendices ⁹		KRP4AA53		
21	Installation box for adaptor PCB		KRP1H98A		
22	Remote sensor (for indoor temperature)		KRCS01-5B		

Note: ¹When installing a fresh air intake kit (chamber type), two air outlet corners are closed.
²It is recommended that the volume of outdoor air introduced through the kit is limited to 10% of the maximum airflow rate of the indoor unit. Introducing higher quantities will increase the operating sound and may also influence temperature sensing.
³The volume of fresh air for direct installation type is approximately 1% of the indoor unit airflow.
 The chamber type is recommended when more fresh air is necessary.
⁴Please order using the names of both components instead of set name.
⁵Filter chamber is required.
⁶Please use in case temperature/humidity inside ceiling may get over 30°C, 80% RH.
⁷Wiring for wired remote controller should be obtained locally.
⁸The indoor unit is equipped standardly with the interface adaptor for SkyAir series. An option is unnecessary.
⁹Installation box for adaptor PCB(KRP1H98A) is necessary.

Round flow type: List of optional parts required to achieve different flow patterns

For each flow pattern – all round, 4-way, 3-way, 2-way, branch duct connection – the compatibility of each independently installed option (shown in the column on the left) to accessory options (listed across the top of each table) is shown in the cells where the relevant row and column intersect. A circle (O) indicates compatibility, and a cross (X) indicates incompatibility. Any options not shown below are not suitable for independent or accessory installation.

Flow pattern	Optionally installable optional parts		Panel spacer ¹	Fresh air intake kit (Chamber type) ^{1,2}	Fresh air intake kit (Direct installation type)	Insulation kit for high humidity	High-efficiency filter unit ²	Ultra long-life filter unit ²
	Independently installable optional parts	Optional accessory parts						
All-round flow 4-way flow	Panel/grille related	Panel spacer ¹		O	O	X	O	O
	Auxiliary function related	Fresh air intake kit (Chamber type) ^{1,2}	O	X	X	O	O	O
		Fresh air intake kit (Direct installation type)	O	X	O	O	O	O
	Filter related	Insulation kit for high humidity	X	X	O	X	X	X
		Ultra long-life filter unit ²	O	O	O	X	X	X
3-way flow 2-way flow ⁵	Panel/grille related	Panel spacer ^{1,3}		△	△	X	X	△
	Auxiliary function related	Fresh air intake kit (Chamber type) ^{1,2}	△	X	X	X	X	O
		Fresh air intake kit (Direct installation type)	△	X	O	X	X	O
	Filter related	Insulation kit for high humidity	X	X	O	X	X	X
		Ultra long-life filter unit ²	△	O	O	X	X	X
Branch duct connection	Branch duct chamber ¹	1-way branch / unit 3-way flow	O	O	O ⁴	X	X	O
		2-way branch / unit 2-way flow	X	O	O ⁴	X	X	O
		1-way branch / unit 2-way flow	X	O	O ⁴	X	X	O

1. In some cases, depending on how the unit is embedded in the ceiling, use of branch ducts and fresh air intake kits may not be possible. Before starting installation work make sure to check whether or not joint installation is possible. In particular, ensure that the lower fixing position caused by the addition of panel spacers is acceptable. When branch ducts are used, circulation airflow is not available.
 2. When two different types of optional chambers are used together, a fresh air intake kit must be installed in the upper position.
 3. It is not possible to use panel spacers in a 2-way flow installation. (△)
 4. It is not possible to install a branch duct on the same side to which a fresh air intake kit (direct mount) is installed.
 5. When 3-way or 2-way flow is selected, circulation airflow is not available.

Indoor unit

COMPACT MULTI FLOW CEILING MOUNTED CASSETTE TYPE

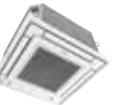

No.	Name of option	Remark	Kit name			
			FFFC35AVM4	FFFC50AVM4	FFFC60AVM4	FFFC71AVM4
1	Grid ceiling panel		BYFQ60CAW			
2	Sensor kit ¹		BRYQ60AAW			
3	Sealing material of air discharge outlet		BDBHQ44C60			
4	Fresh air intake kit		KDDQ44XA60			
5	Replacement long-life filter		KAF441C60			
6	Remote controller	Wireless type Cooling only	BRC7M531W			
7	Navigation remote controller ¹	Wired type ²	BRC1E63			
8	Simplified remote controller	Wired type ²	BRC2E61			
9	Central remote controller		DCS302CA61			
10	Unified ON / OFF controller		DCS301BA61			
11	Schedule timer		DST301BA61			
12	intelligent Touch Controller		DCS601C51			
13	Adaptor for wiring		BRP11B62			
14	Wiring adaptor for electrical appendices(2)		KRP4AA53			
15	Installation box for adaptor PCB		KRP1BB101			
16	Remote sensor (for indoor temperature)		BRCS01A-6			
17	Wireless LAN connecting adaptor		BRP072C42-1			

Note: ¹When sensor kit (BRYQ60AAW) is used, BRC1E63 must be used as wired remote controller. BRC2E61 does not have sensor function.
²Wiring for wired remote controller should be obtained locally.

CEILING SUSPENDED TYPE



No.	Name of option	Remark	Kit name				
			FHFC40DV14 FHFC50DV14	FHFC60DV14	FHFC71DV14	FHFC85DV14	FHFC100DV14 FHFC125DV14 FHFC140DV14
1	Replacement long-life filter	Resin net	KAFJ501D56	KAFJ501D80	KAFJ501D112	KAFJ501D160	KAF501B160
2	Fresh air intake kit		—				KDDQ50A140
3	Drain pump kit		KDU50N60VE	KDU50N125VE			KDU50R160
4	L-type piping kit (for upward direction)		KHFP5M63	KHFP5M160			KHFP5N160
5	Remote controller	Wireless type Cooling only	BRC7EA66				BRC7GA56
6	Simplified remote controller	Wired type ¹	BRC2E61				
7	Central remote controller		DCS302CA61 ²			DCS302CA61 ³	
8	Unified ON/OFF controller		DCS301BA61 ²			DCS301BA61 ³	
9	Schedule timer		DST301BA61 ²			DST301BA61 ³	
10	intelligent Touch Controller		DCS601C51 ²			DCS601C51 ³	
11	Adaptor for wiring		BRP11B61				
12	Wiring adaptor for electrical appendices ⁴		KRP4AA52				
13	Installation box for adaptor PCB		KRP1CA93			KRP1D93A	
14	Interface adaptor for SkyAir series		DTA112BA51				
15	Remote sensor (for indoor temperature)		BRCS01A-1			BRCS01A-4	
16	Electrical box with earth terminal (3 blocks)		KJB311AA				
17	Electrical box with earth terminal (2 blocks)		KJB212AA				

Note: ¹Wiring for wired remote controller should be obtained locally.
²This optional accessory requires DTA112BA51.
³The indoor unit is equipped standardly with the interface adaptor for SkyAir series. An option is unnecessary.
⁴Installation box for adaptor PCB (KRP1CA93, KRP1D93A) is necessary.

DUCT CONNECTION LOW STATIC PRESSURE WIDTH COMPACT TYPE



No.	Name of option	Remark	Kit name	
			FDBF40DV14 FDBF50DV14 FDBF60DV14	FDBF71DV14 FDBF85DV14
1	Remote controller	Wireless type Cooling only	BRC4C66	
2	Simplified Remote Controller	Wired type ¹	BRC2E61	
3	Remote sensor (for indoor temperature)		BRCS01A-1	

Note: ¹Wiring for wired remote controller should be obtained locally.

Indoor unit

DUCT CONNECTION LOW STATIC PRESSURE HEIGHT COMPACT TYPE



No.	Name of option	Remark	Kit name	
			FDLF40DV14 FDLF50DV14 FDLF60DV14	FDLF71DV14 FDLF85DV14
1	Remote controller	Wireless type Cooling only	BRC4C66	
2	Simplified Remote Controller	Wired type ¹	BRC2E61	
3	Remote sensor (for indoor temperature)		BRCS01A-1	

Note: ¹Wiring for wired remote controller should be obtained locally.

DUCT CONNECTION MIDDLE STATIC PRESSURE TYPE



No.	Name of option	Remark	Kit name		
			FBFC40DVM4 FBFC50DVM4 FBFC60DVM4	FBFC71DVM4 FBFC85DVM4	FBFC100DVM4 FBFC125DVM4 FBFC140DVM4
1	Long-life filter ¹		KAF631C56	KAF631C80	KAF631C160
2	High-efficiency filter ¹	65%	KAF632C56	KAF632C80	KAF632C160
		90%	KAF633C56	KAF633C80	KAF633C160
3	Filter chamber(for rear suction) ¹		KDDFP63B56	KDDFP63B80	KDDFP63B160
4	Service panel	Fresh white	KTBJ25K56F	KTBJ25K80F	KTBJ25K160F
5	Air discharge adaptor		KDAP25A56A	KDAP25A71A	KDAP25A140A
6	Shield plate for side plate		KDBD63A160		
7	Remote controller	Wireless type Cooling only	BRC4C66		
8	Simplified Remote Controller	Wired type ²	BRC2E61		
9	Remote sensor (for indoor temperature)		BRCS01A-4		
10	Adaptor for wiring ³		BRP11B62*		
11	Wiring adaptor for electrical appendices(2) ³		KRP4AA51*		
12	Mounting plate for adaptor PCB. ^{3,4,5}		KRP4A98		
13	Central remote controller ⁶		DCS302CA61		
14	Unified ON/OFF controller ⁶		DCS301BA61		
15	Schedule timer ⁶		DST301BA61		
16	intelligent Touch Controller ⁶		DCS601C51		
17	Drain pump kit		BDU24AMD2		

Note: ¹If installing high efficiency filter and long-life filter to the unit, filter chamber is required.
²Wiring for wired remote controller should be obtained locally.
³Mounting plate is necessary for each adaptor marked*.

⁴Up to 2 adaptors can be fixed for each mounting plate.
⁵Only one mounting plate can be installed for each indoor unit.
⁶The indoor unit is equipped standardly with the interface adaptor for SkyAir series. An option is unnecessary.

Outdoor unit

No.	Name of option	1 Phase	Kit name			
			RZFC35EVM4	RZFC40/50/60/71DVM4	RZFC85/100DVM4	—
		3 Phase	—	—	RZFC71/85/100DY14	RZFC125/140DY14
1	Central drain plug		KKP937A4	KKP014A4	KKP937A4	KKPJ5G280
2	Fixture for preventing overturning		—	—	—	KKTP5B112
3	Wire fixture for preventing overturning		—	—	—	K-KYZP15C
4	Air direction adjustment grille		KPW937F4		KPW5G112	

CEILING MOUNTED CASSETTE TYPE / Standard panel

[FCFC40/50/60DVM4]

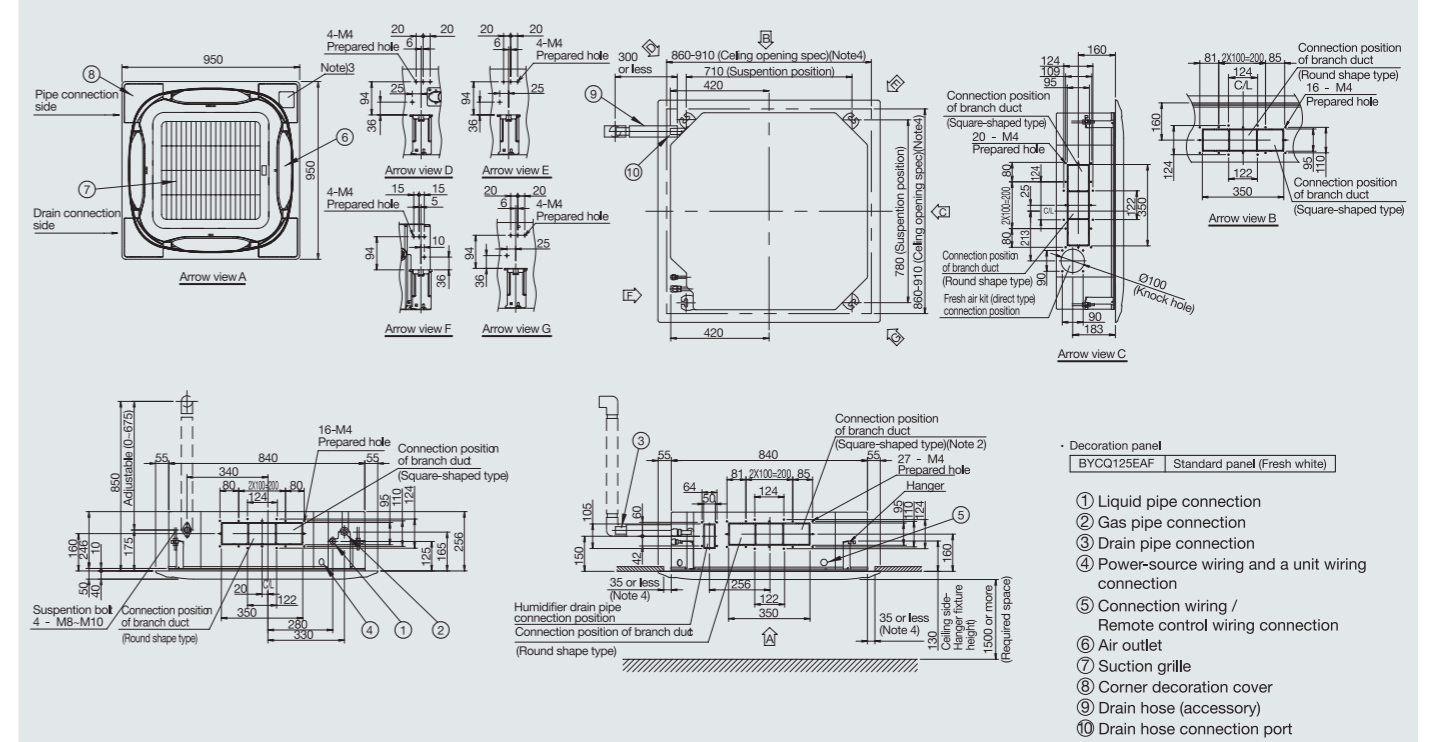

- Note:
- Sticking location for Manufacturer's label
 Manufacturer's label for Indoor unit : Suction grille inner side's electric components box's lid surface.
 Manufacturer's label for Decoration panel : Decoration panel's corner decoration cover inner surface.
 - In case of having option part built-in, please refer outside drawing of option part.
 Fresh air intake kit.....inspection hole Need
 Natural evaporate type humidifier.....inspection hole Need
 Air purifier unit.....inspection hole No Need
 High efficiency filter unit.....inspection hole No Need
 Branch duct chamber.....inspection hole No Need (both angle duct • circle duct)
 - In case of using wireless remote controller, this position will be a signal receiver. Refer to the drawing of wireless remote controller in detail.
 - Though the installation is acceptable up to maximum of 910 mm square ceiling opening, keep the clearance of 35mm or less between the indoor unit and the ceiling opening so that the panel overlap allowance can be ensured.
 - When the temperature and humidity in the ceiling exceed 30°C and 80% RH or the fresh air is inducted into the ceiling or the unit continues 24 hour operation, an additional insulation (thickness 10mm or more of glasswool or polyethylene form) is required.
 - Please do not place the thing been damp and troubled under an indoor unit. when the case where humidity is 80% or more, and the drain outlet are choked up and the air filter are dirty, dew may fall.
 - If put vent hole, lighting, equipment near the air flow disturb equipment, ceiling surface may get dirty, therefore shall install following to diagram as below.

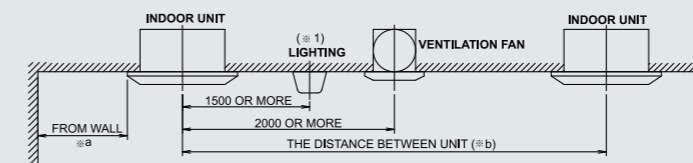
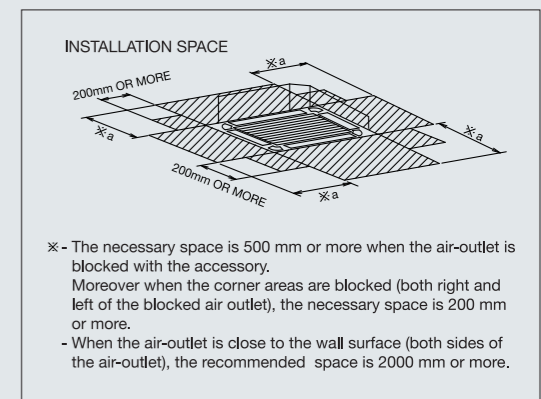

CEILING MOUNTED CASSETTE TYPE / Standard panel

[FCFC71/85DVM4]

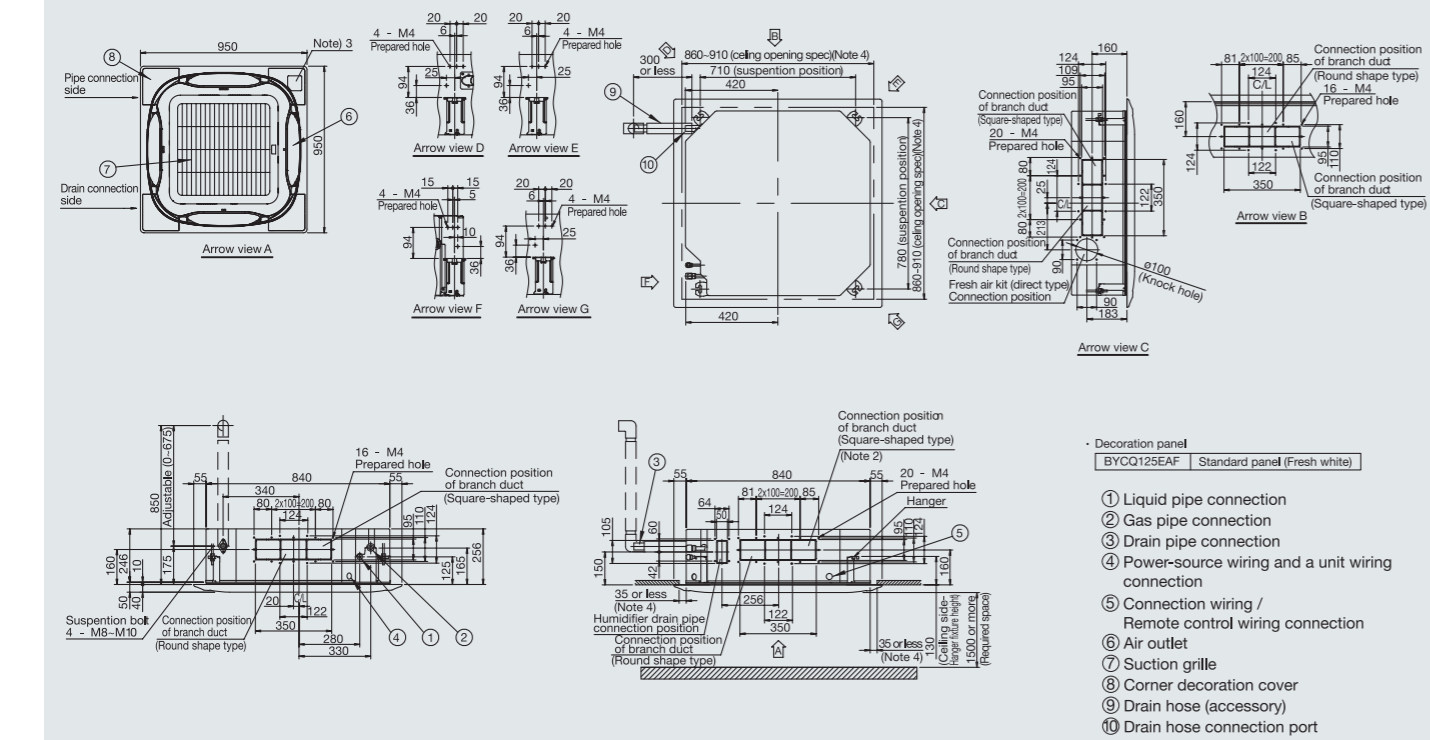

- Note:
1. Sticking location for Manufacturer's label
 Manufacturer's label for Indoor unit : Suction grille inner side's electric components box's lid surface.
 Manufacturer's label for Decoration panel : Decoration panel's corner decoration cover inner surface.
 2. In case of having option part built-in, please refer outside drawing of option part.
 Fresh air intake kit.....inspection hole Need
 Natural evaporate type humidifier.....inspection hole Need
 Air purifier unit.....inspection hole No Need
 High efficiency filter unit.....inspection hole No Need
 Branch duct chamber.....inspection hole No Need
 (both angle duct • circle duct)
 3. In case of using wireless remote controller, this position will be a signal receiver.
 Refer to the drawing of wireless remote controller in detail.
 4. Though the installation is acceptable up to maximum of 910 mm square ceiling opening, keep the clearance of 35mm or less between the indoor unit and the ceiling opening so that the panel overlap allowance can be ensured.
 5. When the temperature and humidity in the ceiling exceed 30°C and 80% RH or the fresh air is inducted into the ceiling or the unit continues 24 hour operation, an additional insulation (thickness 10mm or more of glasswool or polyethylene form) is required.
 6. Please do not place the thing been damp and troubled under an indoor unit, when the case where humidity is 80% or more, and the drain outlet are choked up and the air filter are dirty, dew may fall.
 7. If put vent hole, lighting, equipment near the air flow disturb equipment, ceiling surface may get dirty, therefore shall install following to diagram as below.

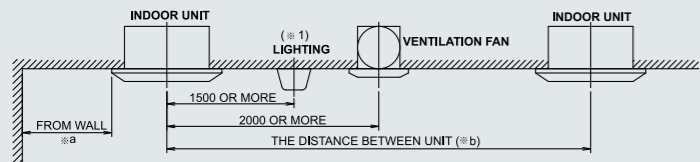
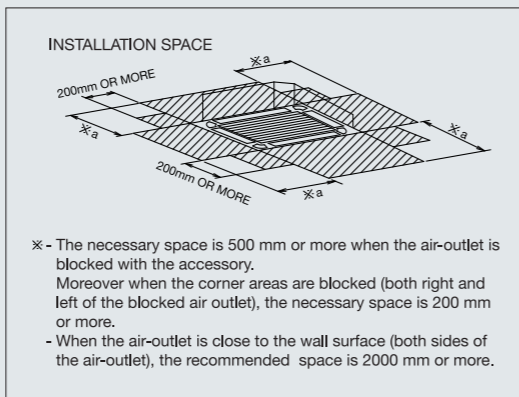

CEILING MOUNTED CASSETTE TYPE / Standard panel

[FCFC100/125/140DVM4]

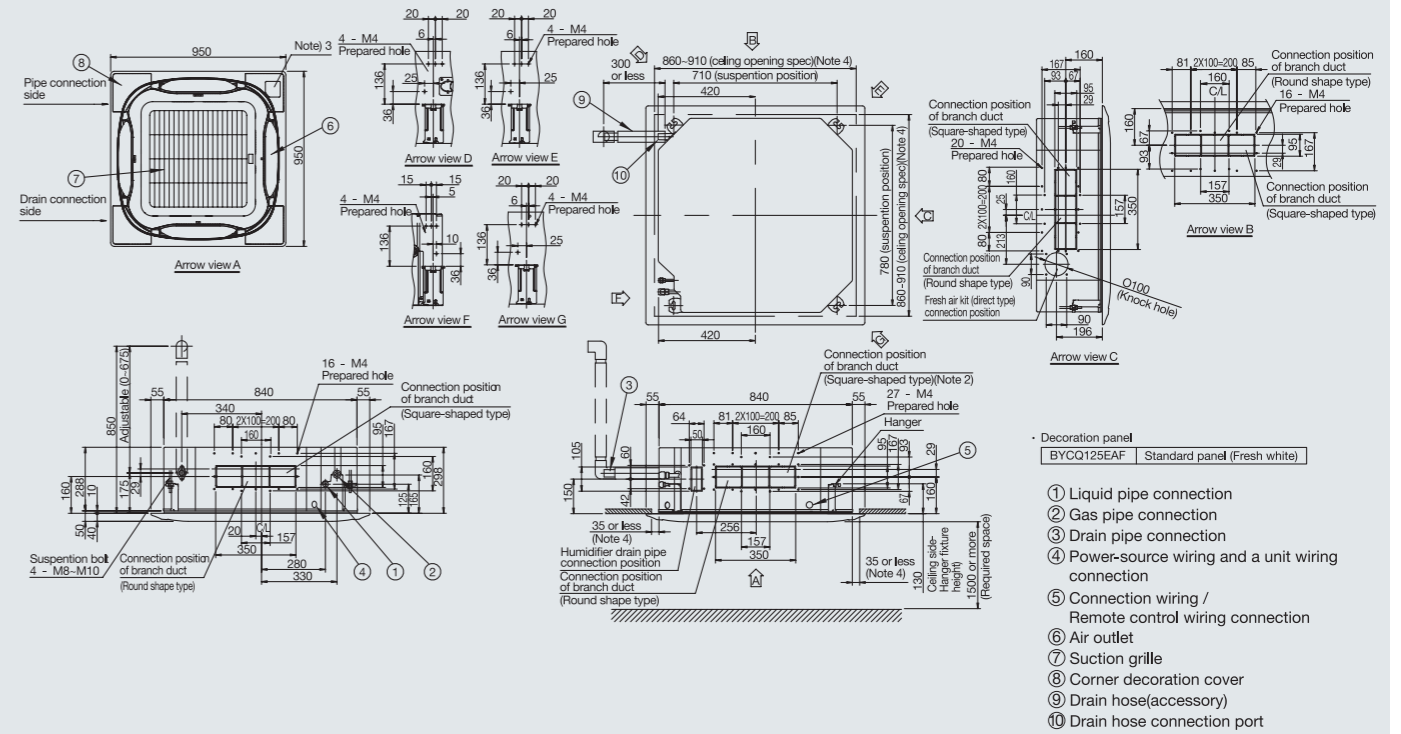

- Note:
1. Sticking location for Manufacturer's label
 Manufacturer's label for Indoor unit : Suction grille inner side's electric components box's lid surface.
 Manufacturer's label for Decoration panel : Decoration panel's corner decoration cover inner surface.
 2. In case of having option part built-in, please refer outside drawing of option part.
 Fresh air intake kit.....inspection hole Need
 Natural evaporate type humidifier.....inspection hole Need
 Air purifier unit.....inspection hole No Need
 High efficiency filter unit.....inspection hole No Need
 Branch duct chamber.....inspection hole No Need
 (both angle duct • circle duct)
 3. In case of using wireless remote controller, this position will be a signal receiver.
 Refer to the drawing of wireless remote controller in detail.
 4. Though the installation is acceptable up to maximum of 910 mm square ceiling opening, keep the clearance of 35mm or less between the indoor unit and the ceiling opening so that the panel overlap allowance can be ensured.
 5. When the temperature and humidity in the ceiling exceed 30°C and 80% RH or the fresh air is inducted into the ceiling or the unit continues 24 hour operation, an additional insulation (thickness 10mm or more of glasswool or polyethylene form) is required.
 6. Please do not place the thing been damp and troubled under an indoor unit, when the case where humidity is 80% or more, and the drain outlet are choked up and the air filter are dirty, dew may fall.
 7. If put vent hole, lighting, equipment near the air flow disturb equipment, ceiling surface may get dirty, therefore shall install following to diagram as below.

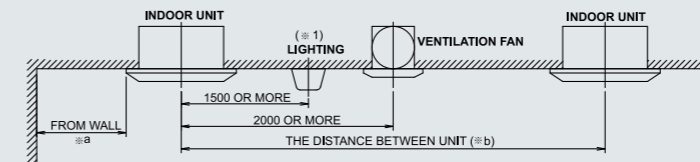
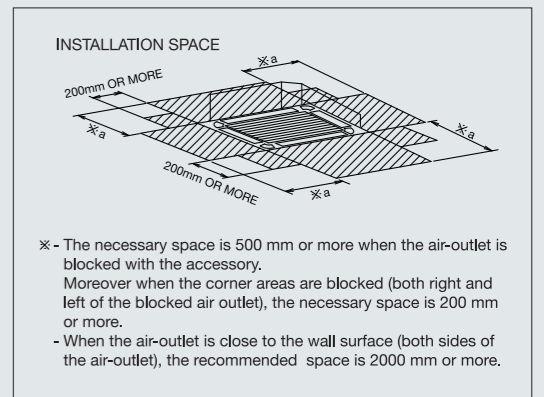

COMPACT MULTI FLOW CEILING MOUNTED CASSETTE TYPE / Grid ceiling panel

[FFFC35/50/60/71AVM4]

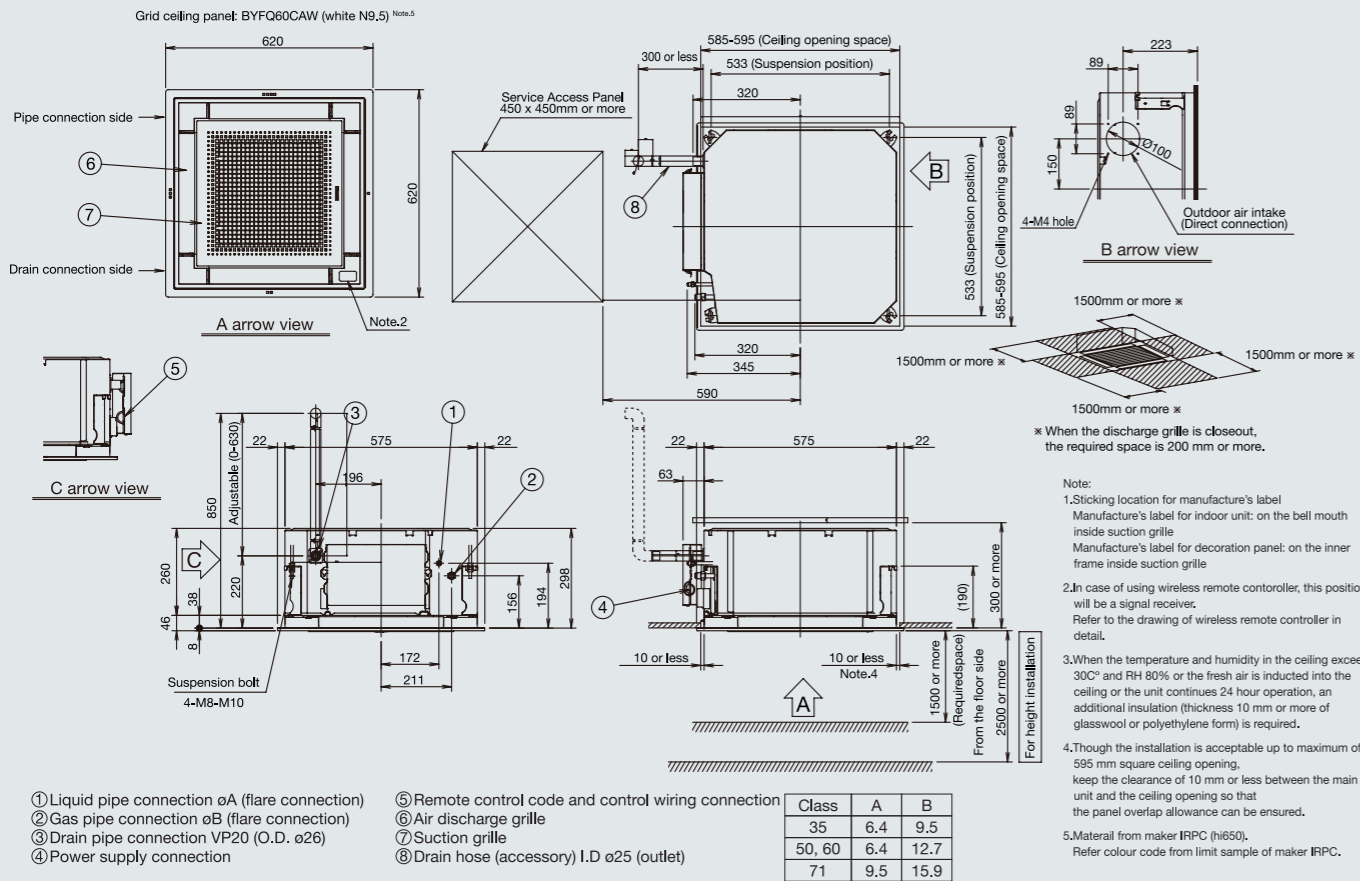

CEILING SUSPENDED TYPE

[FHFC40/50DV14]

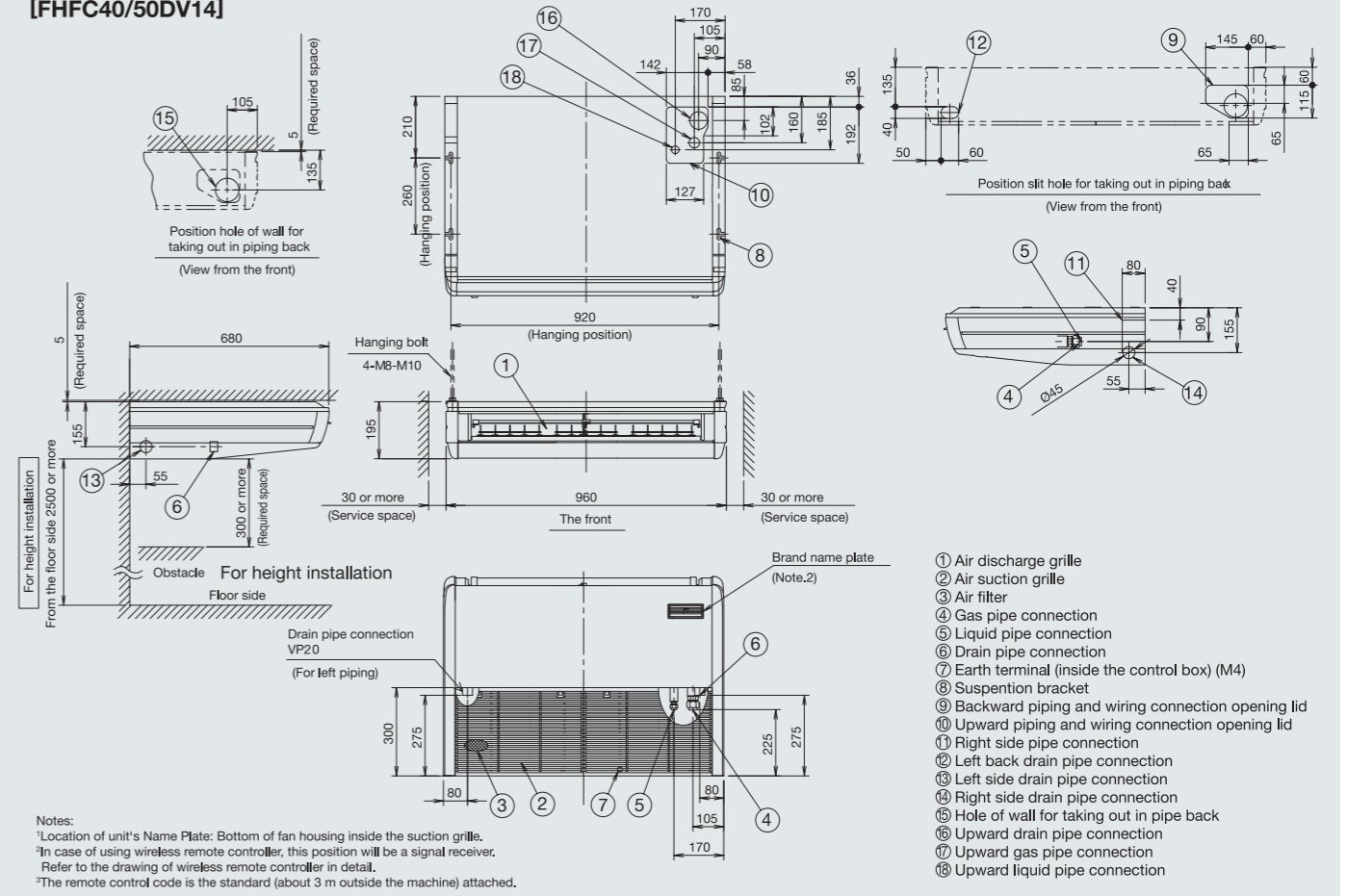

CEILING SUSPENDED TYPE

[FHFC60DV14]

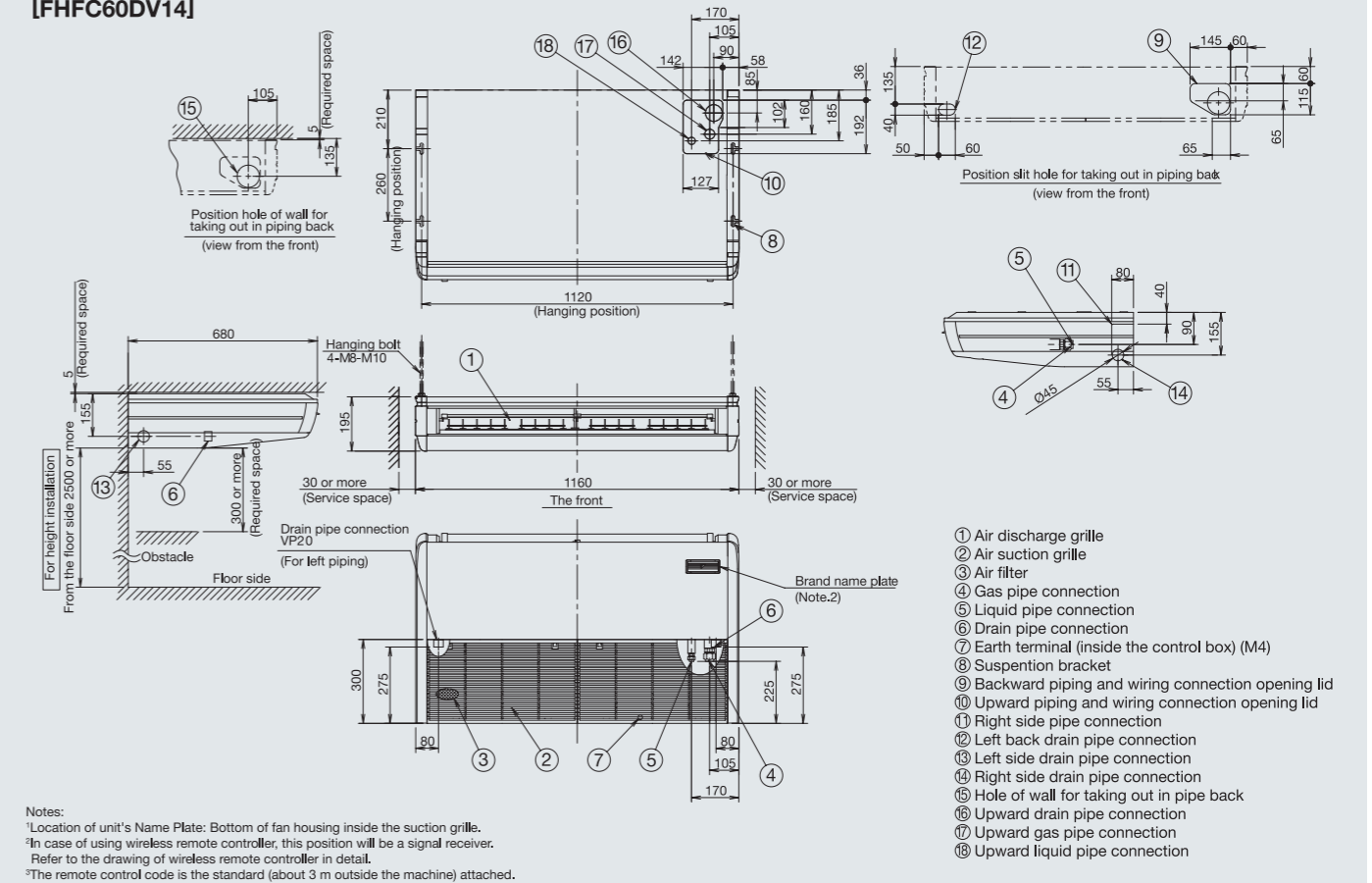

CEILING SUSPENDED TYPE

[FHFC71DV14]

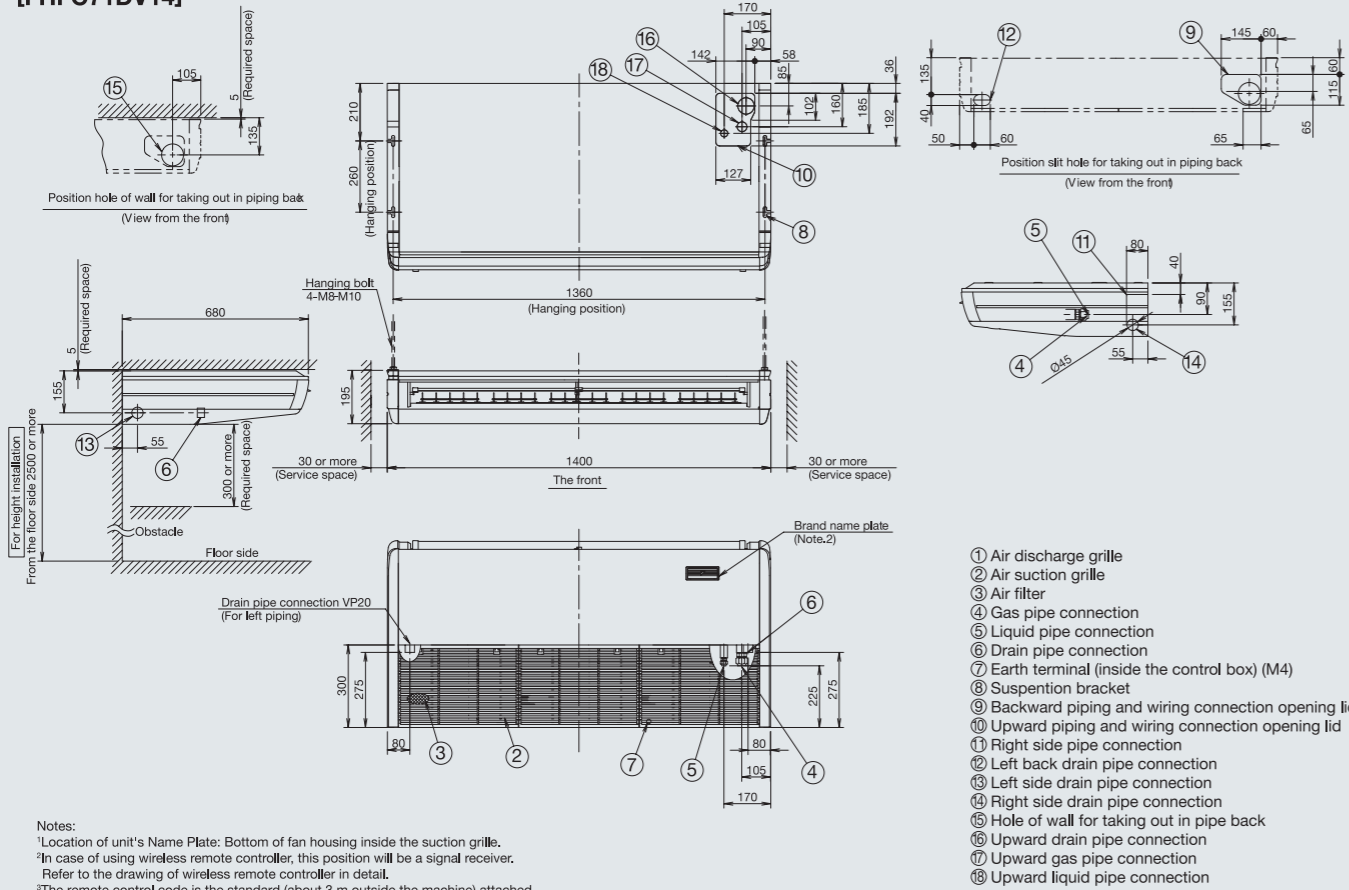

CEILING SUSPENDED TYPE

[FHFC100/125/140DV14]

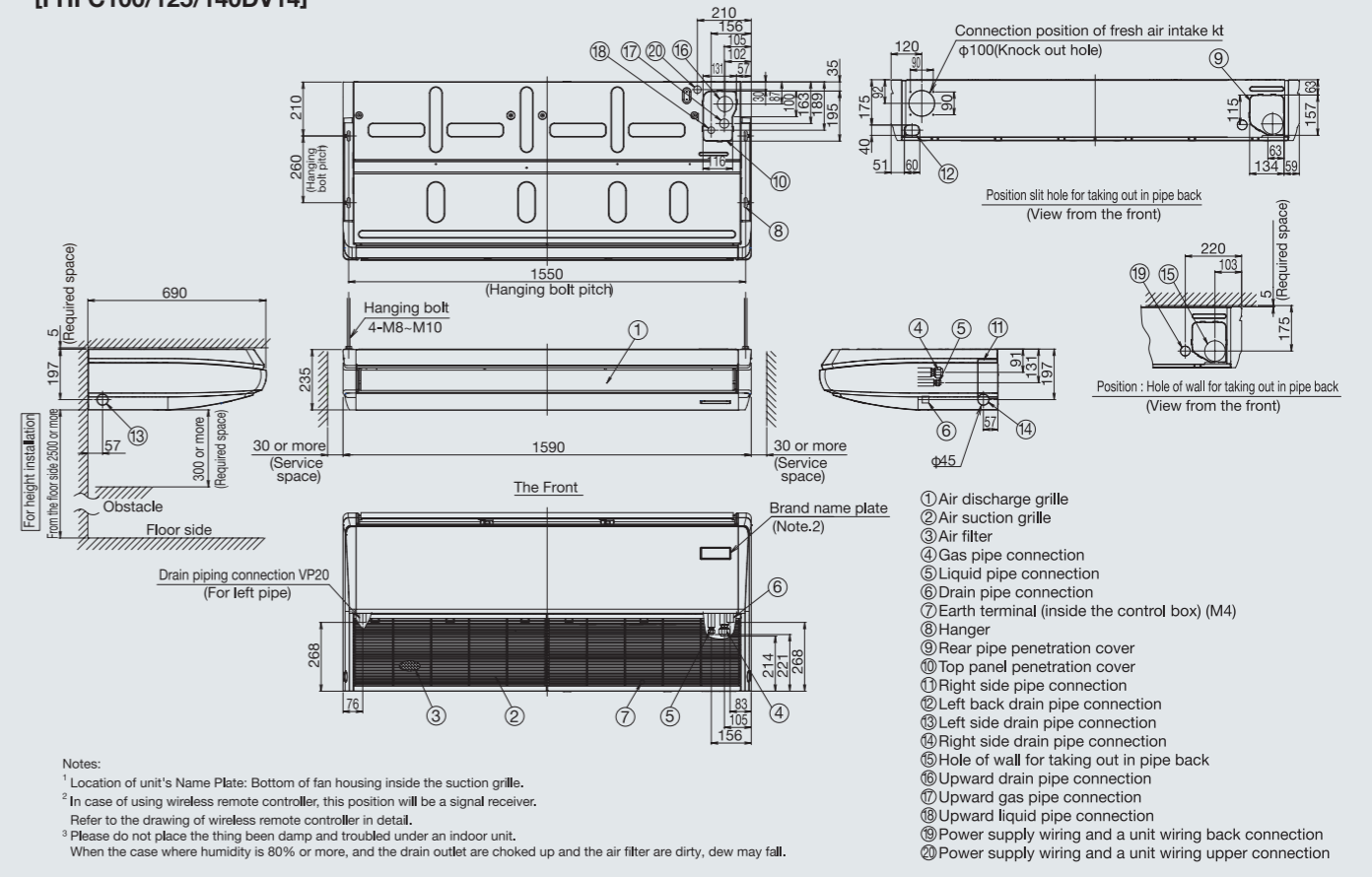

CEILING SUSPENDED TYPE

[FHFC85DV14]

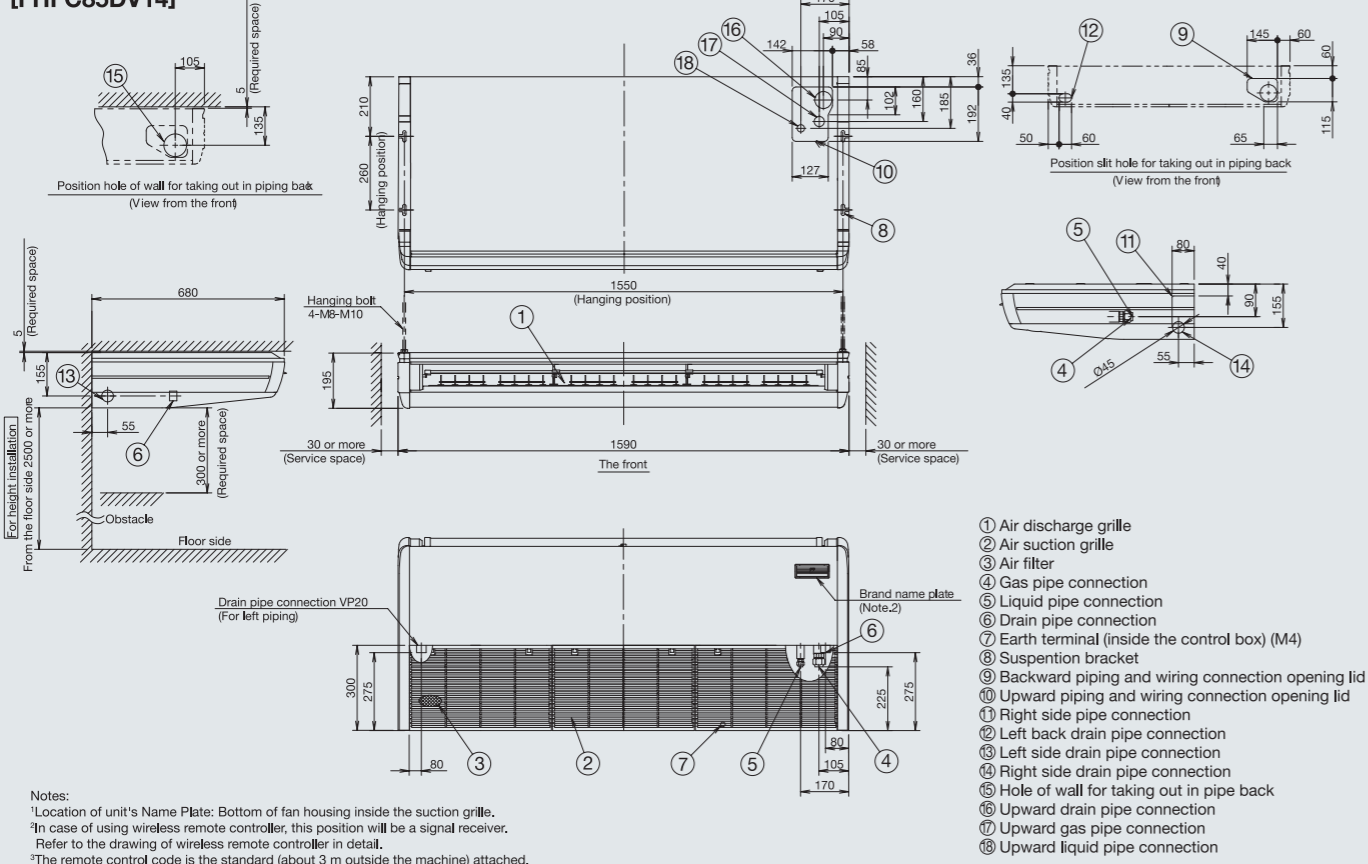

DUCT CONNECTION LOW STATIC PRESSURE WIDTH COMPACT TYPE

[FDBF40/50/60DV14]

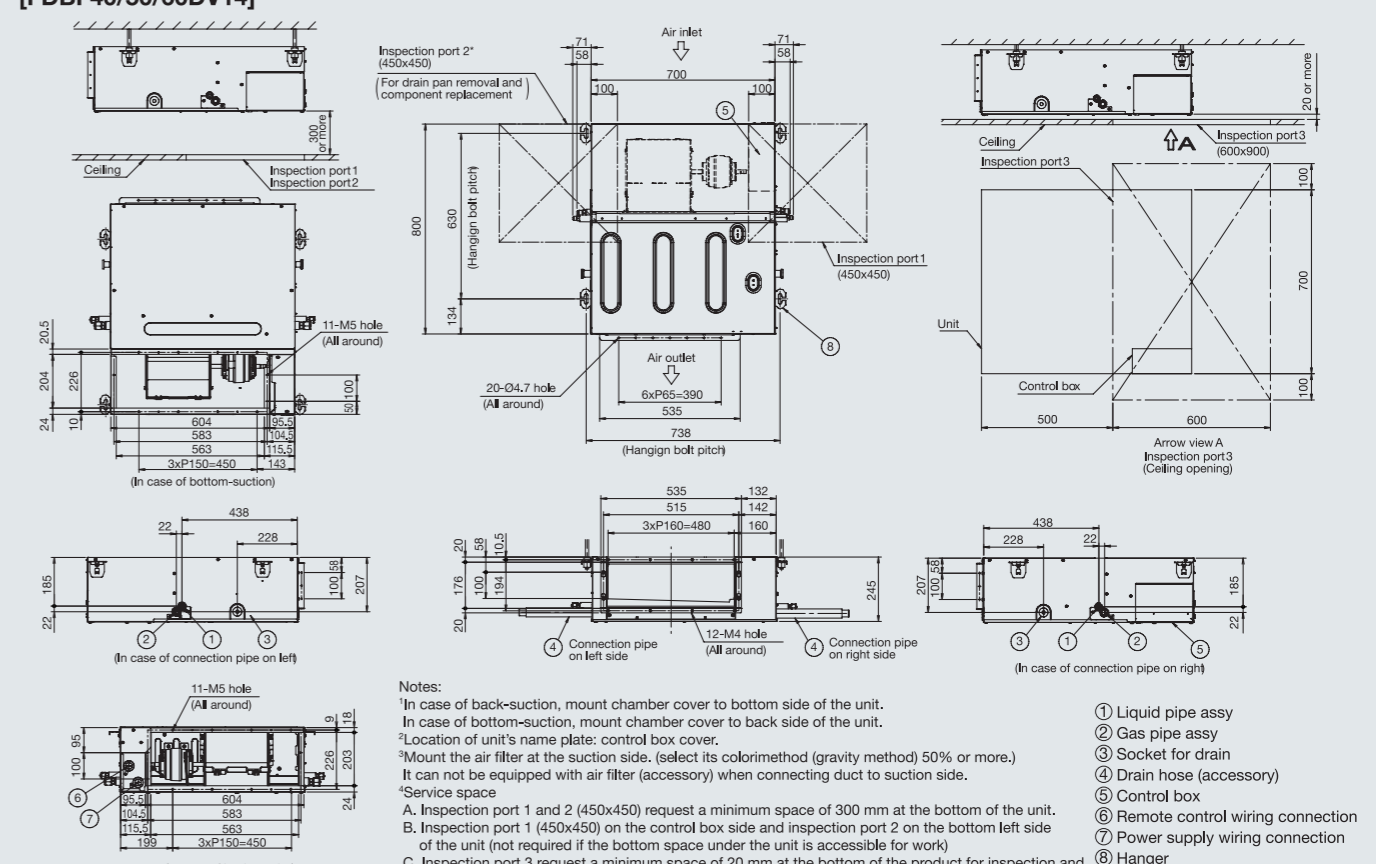

DUCT CONNECTION LOW STATIC PRESSURE WIDTH COMPACT TYPE

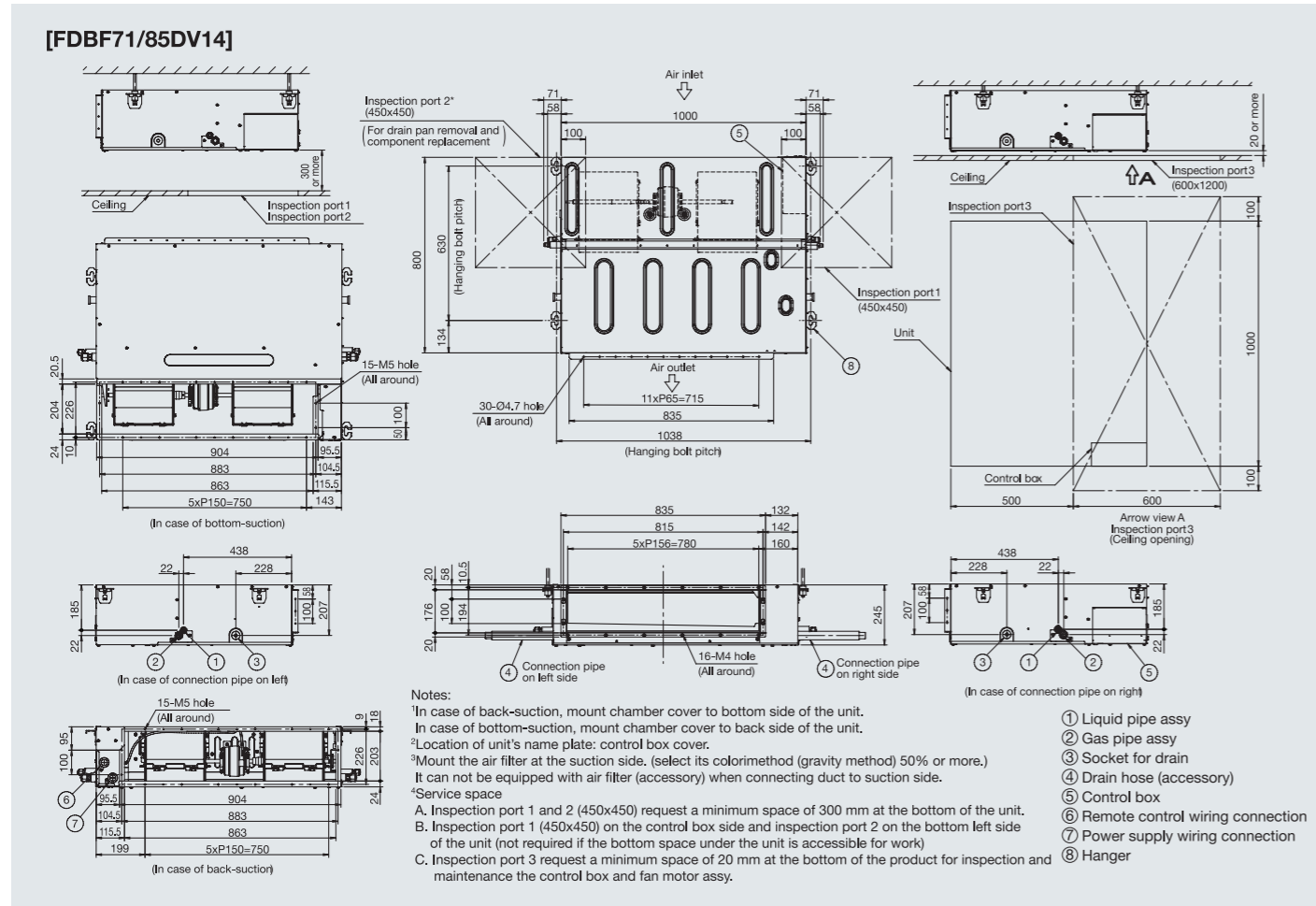

DUCT CONNECTION LOW STATIC PRESSURE HEIGHT COMPACT TYPE

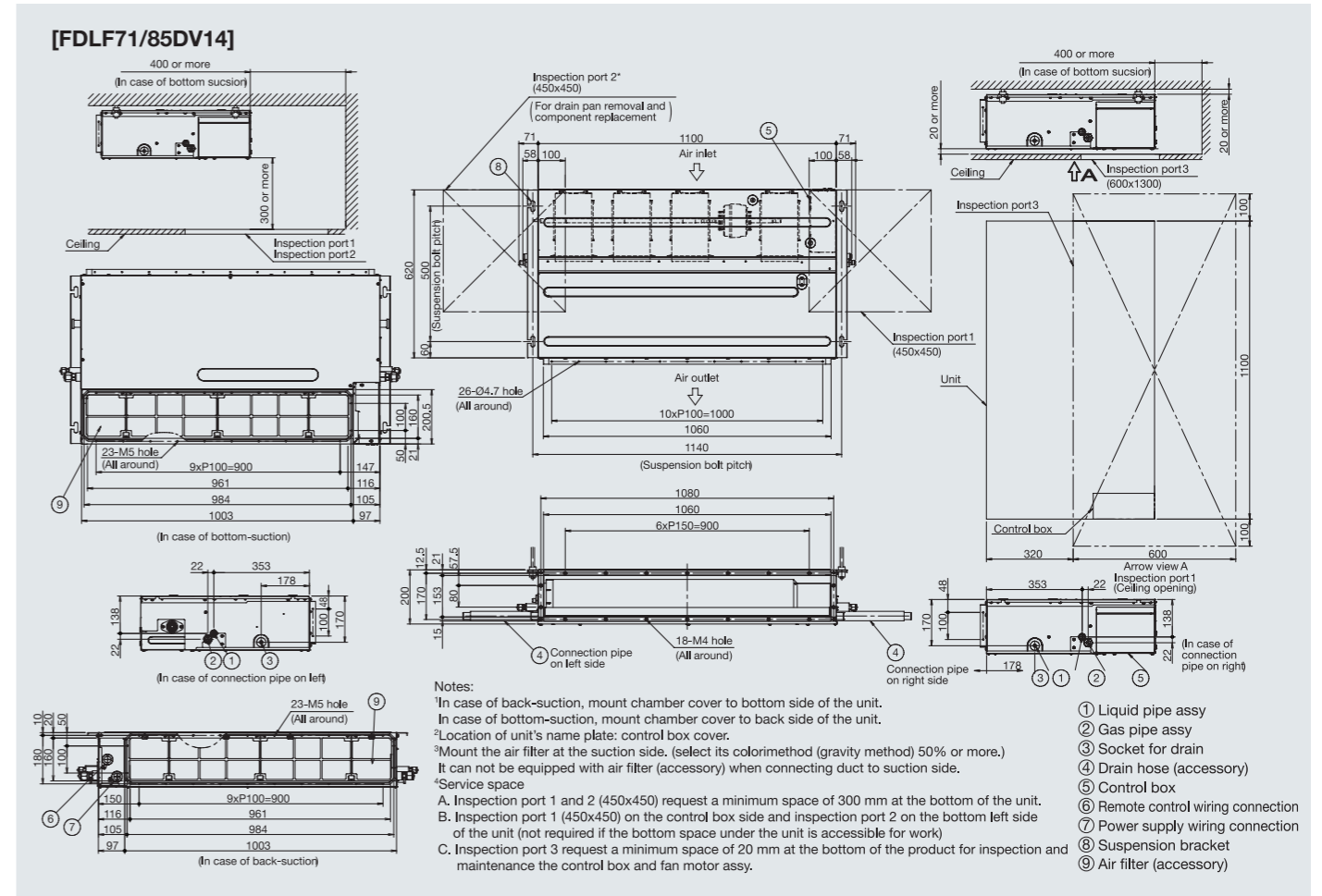

DUCT CONNECTION LOW STATIC PRESSURE HEIGHT COMPACT TYPE

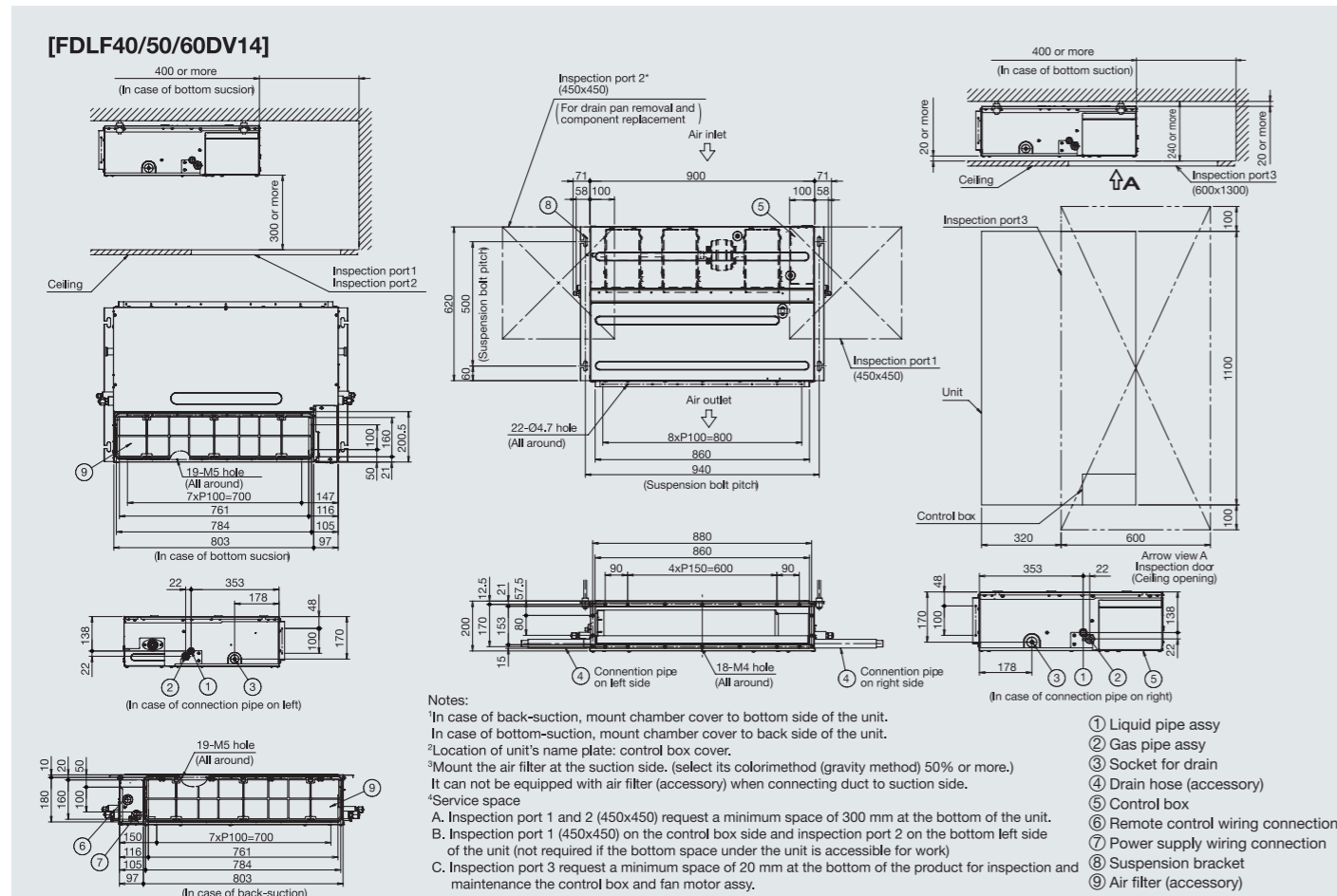

DUCT CONNECTION MIDDLE STATIC PRESSURE TYPE

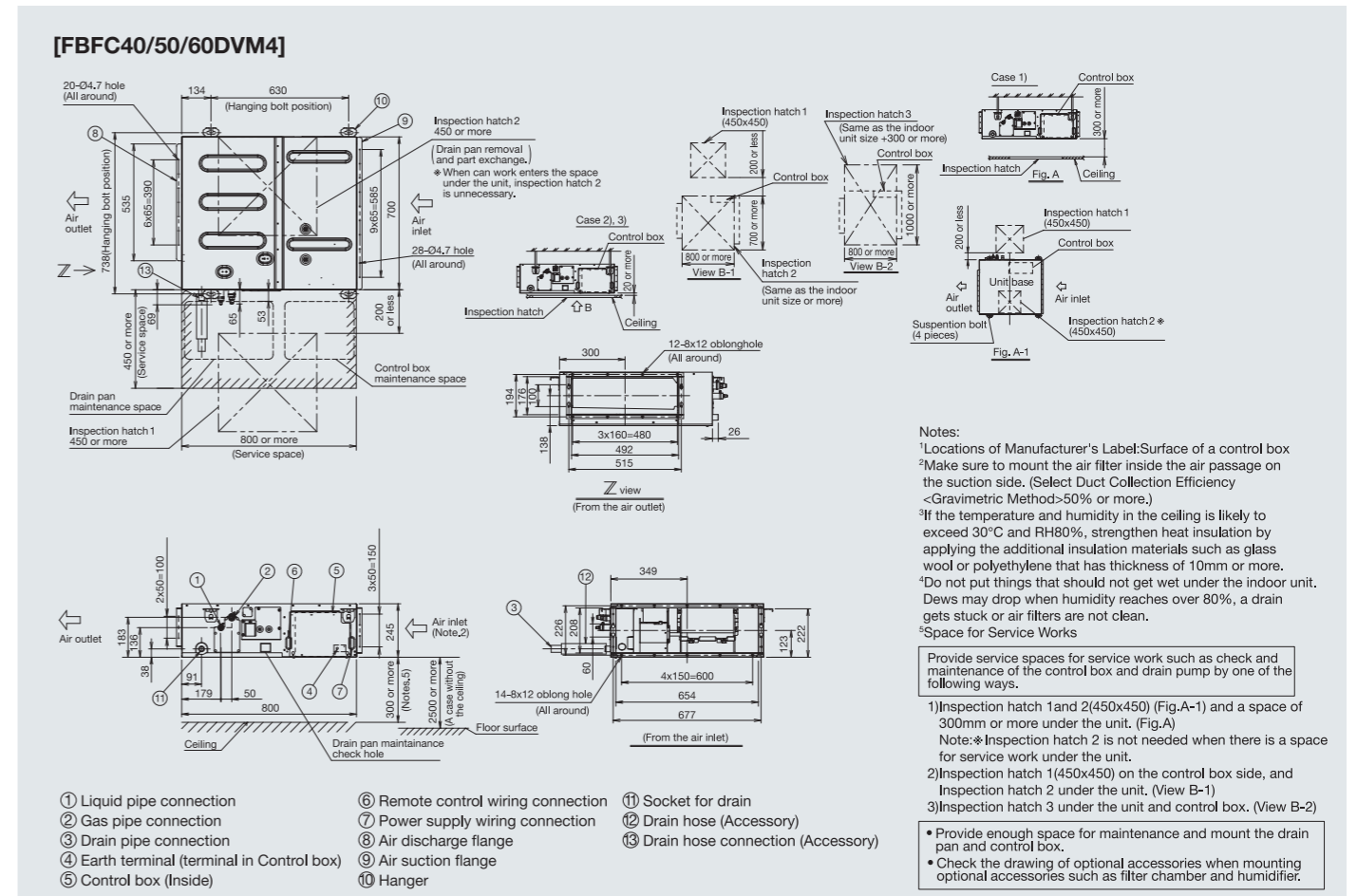

REMOTE CONTROLLER

《Wireless type》

• Remote controller dimensions

BRC4C, 7E/F/G

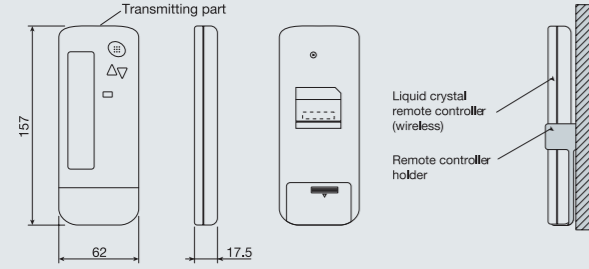

• Remote controller holder installation procedure
<installation to wall surface>

BRC7M

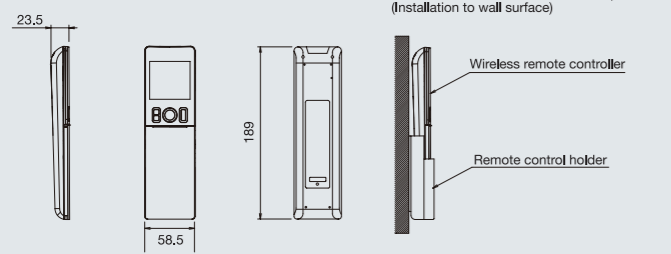

• Remote controller holder installation procedure
(Installation to wall surface)

CEILING SUSPENDED TYPE

• Receiver installation procedure

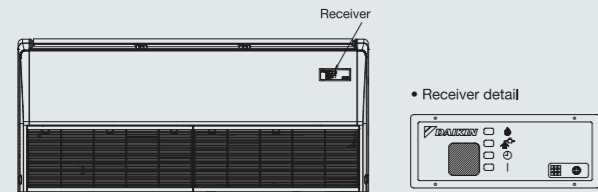
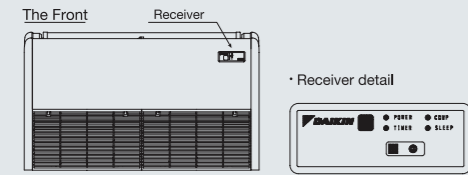

CEILING MOUNTED CASSETTE TYPE <Round Flow>

• Receiver installation procedure

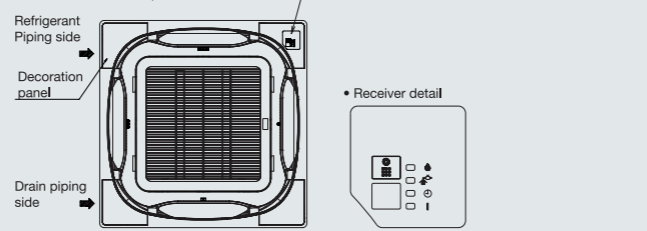

COMPACT MULTI FLOW CEILING MOUNTED CASSETTE / Grid ceiling panel

• Receiver installation procedure

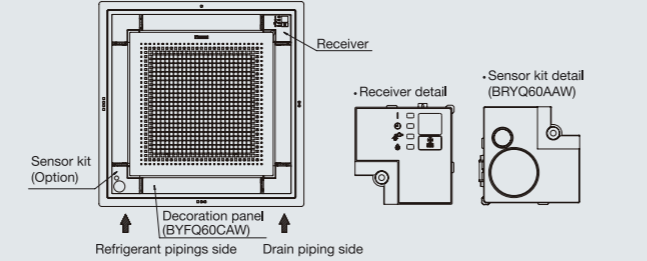

DUCT CONNECTION LOW STATIC PRESSURE TYPE
DUCT CONNECTION MIDDLE STATIC PRESSURE TYPE

• Receiver detail

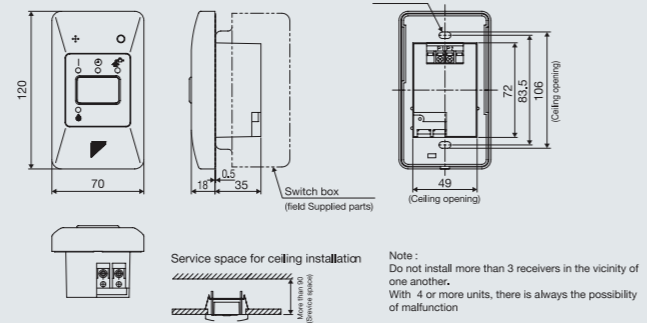

《Wired type》 • Remote controller dimensions

BRC2E61

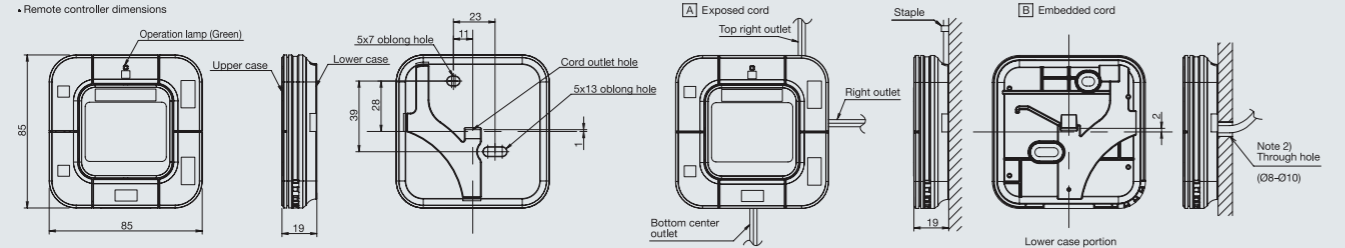

BRC1E63

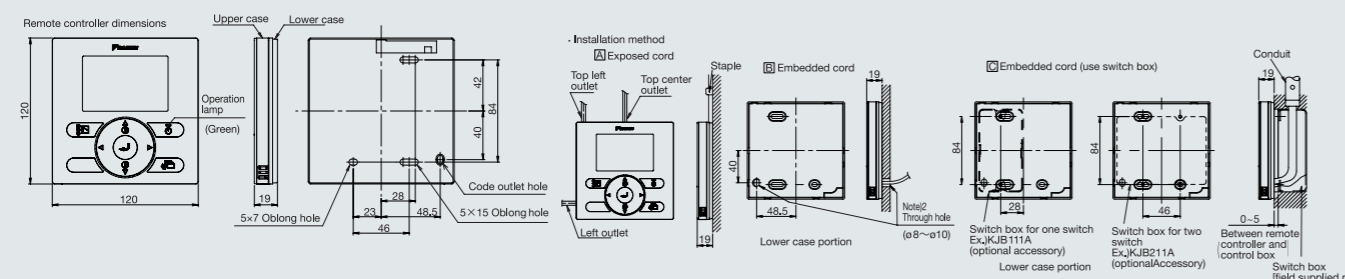

Note
1. Remote controller cord and staple are not attached. They are field supplied parts.
2. If the hole size is too large or the location is not proper, the hole may come out from the remote controller.

Specifications of cord

Type	Vinyl cord with sheath or cable (insulated thickness: 1mm or more)
Size	0.75~1.25 mm ²
Total length	500 m

■ For RZFC40-100DVM4, RZFC71-140DY14 series

★1.RZFC40-100DVM4 ★2.RZFC71-100DY14 ★3.RZFC125/140DY14

1 When there is an obstruction on the inlet side

1) When the overhead space is open

1. For single unit installation

When there is an obstruction only on the inlet side

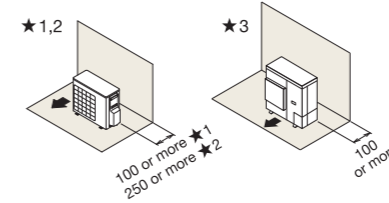

When there are obstructions on both sides

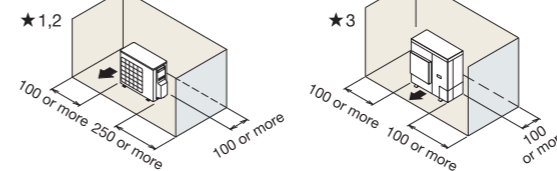

2. For multiple units installation (more than two units)

When there are obstructions on both sides

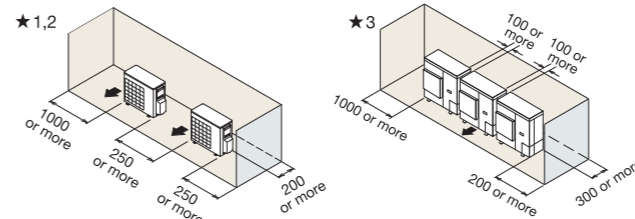

2) When there is an obstruction in the overhead space

1. For single unit installation

When there is an obstruction on the inlet side

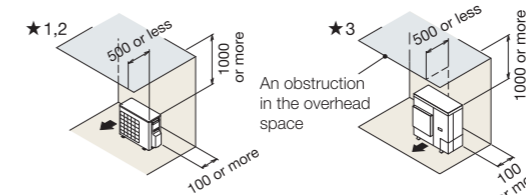

When there are obstructions on the inlet side and both lateral sides

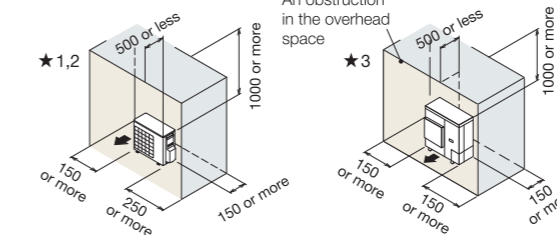

2. For series installation (more than two units)

When there are obstructions on the inlet side and both lateral sides

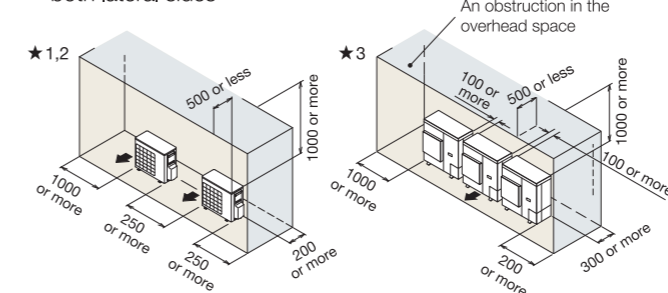

2 When there is an obstruction on the outlet side

1) When the overhead space is open

1. For single unit installation

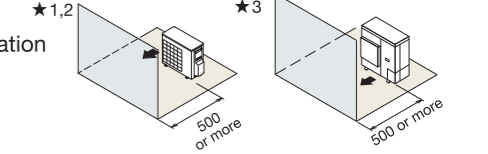

2. For multiple units installation (more than two units)

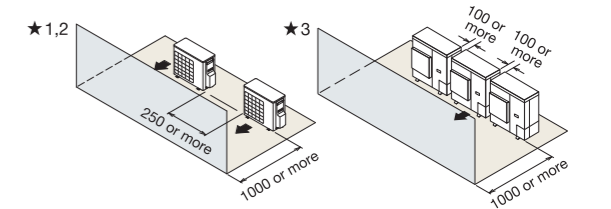

2) When there is an obstruction in the overhead space

1. For single unit installation

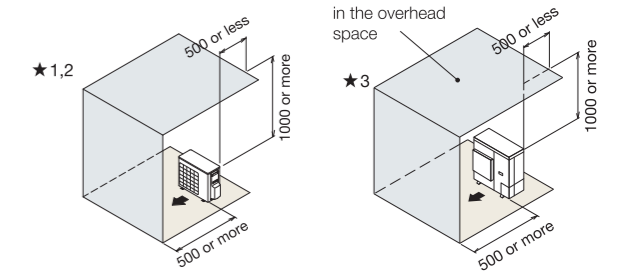

2. For multiple units installation (more than two units)

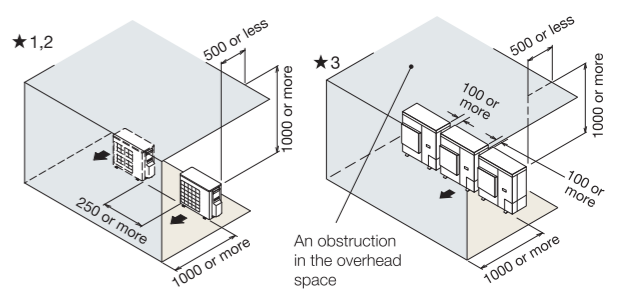

3 When there are obstructions on both the inlet and outlet sides

(When the obstruction on the outlet side is higher than the unit itself)

1) When the overhead space is open

(There is no limit to the height of the obstruction on the outlet side.)

1. For single unit installation

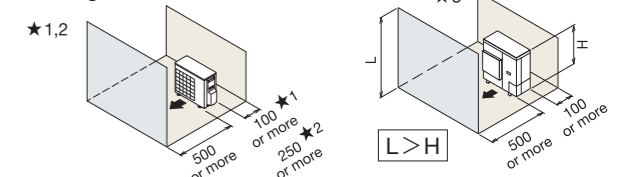

2. For series installation (more than two units)

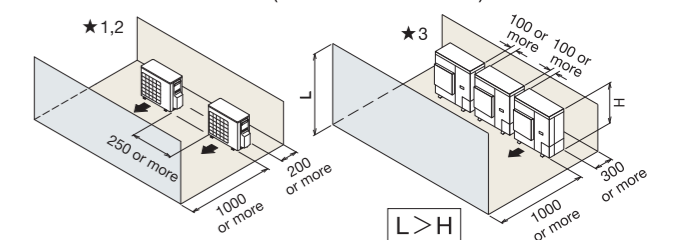

Note : As for other patterns of installation, please refer to Installation manual or Engineering Data Book.