



Perfecting the Air

- Ask a qualified installer or contractor to install this product. Do not try to install the product yourself. Improper installation can result in water or refrigerant leakage, electrical shock, fire or explosion.
- Use only those parts and accessories supplied or specified by Daikin. Ask a qualified installer or contractor to install those parts and accessories can result in water or refrigerant leakage, electrical shock, fire or explosion.
- Read the user's manual carefully before using this product. The user's manual provides important safety instructions and warnings. Be sure to follow these instructions and warnings.

If you have enquiries, please contact your local importer, distributor and/or retailer.

**DEALER RESMI**

**Cautions on product corrosion**

1. Air conditioners should not be installed in areas where corrosive gases, such as acid gas or alkaline gas, are produced.
2. If the outdoor unit is to be installed close to the sea shore, direct exposure to the sea breeze should be avoided. If you need to install the outdoor unit close to the sea shore, contact your local distributor.

**DCC 0800 1 081 081**  
**DAIKIN CONTACT CENTER**

**Jam Beroperasi:**

Senin - Jumat: 07:00 - 19:00 WIB

Sabtu - Minggu & Libur Nasional: 07:00 - 17:00 WIB

**PT. DAIKIN AIRCONDITIONING INDONESIA**

Menara Astra 7th & 8th Floor, Jl. Jenderal Sudirman Kav. 5-6,  
 Kel. Karet Tengsin, Kec. Tanah Abang, Jakarta Pusat, DKI Jakarta - 10220  
 Telp : +6221 8665 6886 | Website : www.daikin.co.id

• **SERVICE CENTER** : Jakarta Selatan, Telp. : 021-2782 5545 | Samarinda, Telp. : 0541-252 2889 • **WORKSHOP**: Cirebon, Telp.: 0231-8817 512 | Banjarmasin, Tlp. : 0511-6776 838 | Aceh, Tlp. : 0651-7318 036 | Lombok, Tlp. : 0370-7843 231 | Jambi, Tlp. : 0741-3066 790 | Padang, Tlp. : 0751-896 2684 • **TRAINING CENTER** : Sunter, Telp. : 021-650 5030 • **BRANCH** : Bekasi, Telp. :021-2945 0585 | Tangerang, Telp. : 021-5314 1195 | Bandung, Telp. : 022-522 5150 | Semarang, Telp. : 024-7660 3221 | Yogyakarta, Telp. : 0274-551 321 | Surabaya, Telp. : 031-503 1138 | Denpasar, Telp. : 0361-900 5514 | Makassar, Telp. : 0411-805 2691 | Palembang, Telp. : 0711-573 2282 | Pekanbaru, Telp. : 0761-561 139 | Medan, Telp. : 061-4200 8866 | Manado, Telp. : 0431-719 1199 | Batam, Tlp. : 0778-4171 445



Management System  
 ISO 9001:2015

www.tuv.com  
 ID 9105084313



**VRV X**

Cooling Only 50 Hz

**R-410A**

# Exceeding Boundaries with Innovative Energy Savings



New

## VRV X

First launched in Japan in 1982, the Daikin **VRV** system has been embraced by world markets for over 35 years. Now, Daikin proudly introduces the new **VRV X** series. By combining the technologies of **VRV**, **VRT** and **VAV**, we have attained both energy savings and comfortable air conditioning.

# VRV + VRT + VAV

### Energy savings

Uniting **VRV**, **VRT** and **VAV** technologies

### Automatic refrigerant charge function

- Optimised operation efficiency
- Higher installation quality
- Easier installation

### High reliability

- New inverter PC board
- Double backup operation
- Refrigerant cooling for PC board

\* **VRV** is a trademark of Daikin Industries, Ltd.

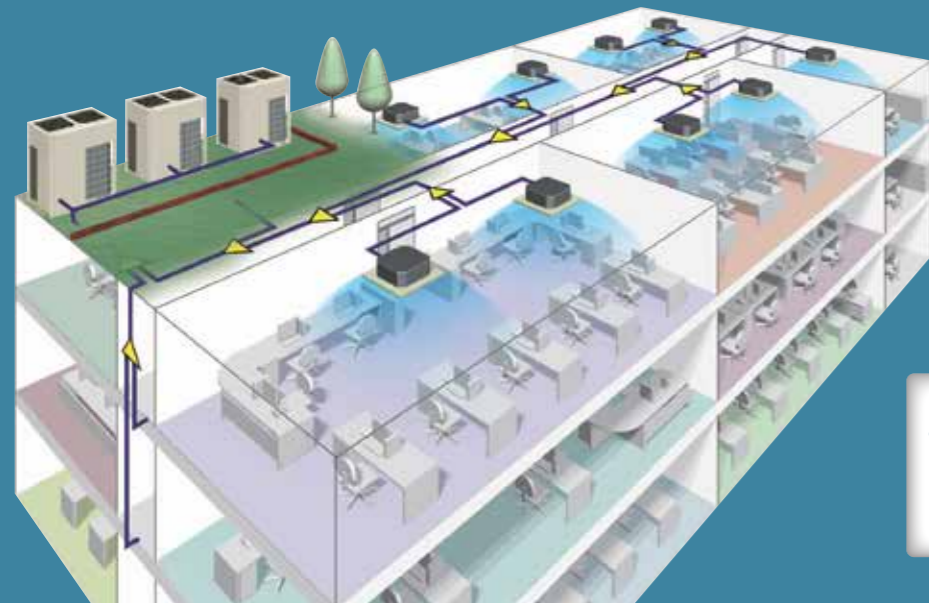

RXUQ-A

\* To be released in the latter half of 2018. Please contact Daikin sales office for more information.

**Cooling Only**  
**6 HP - 60 HP**  
 (16.0 kW) (168 kW)

## Advanced technologies for greater energy savings

### VRV+VRT+VAI

By uniting advanced **software** and **hardware** technologies for greater energy savings during actual operation and combining the technologies of VRV, VRT and VAV, we have attained both energy savings and comfortable air conditioning.

### VRT Smart Control (Fully Automatic Energy-saving Refrigerant Control)

Software technology

#### Optimally supply only for the needed capacity of indoor units

Daikin developed VRT smart control by combining air volume control (VAV: Variable Air Volume) for indoor units with conventional VRT control, which optimises compressor speed by calculating the required load for the entire system and optimal target refrigerant temperature based on data sent from each indoor unit. Coordination with the air volume control reduces compressor load and minimises operation loss based on detailed control. VRT smart control ensures energy savings and comfortable air conditioning to meet actual operating conditions.



VRT Smart Control Function movie

#### Overview of the control (system control flow)

Different automatic energy-saving refrigerant control applies depending on the indoor units connected.

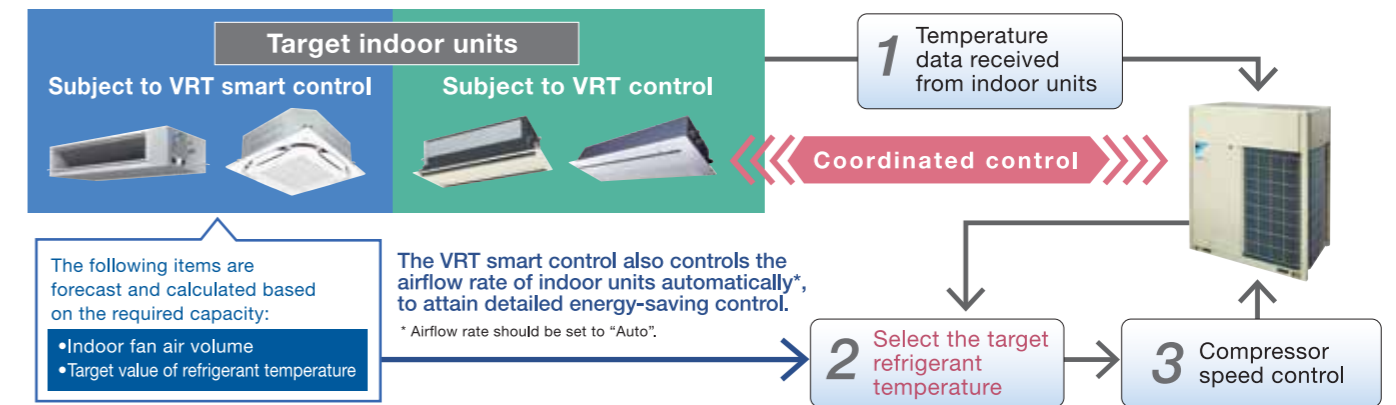

The smooth control (which keeps the compressor running) saves energy and ensures comfort during low-load operation.

#### Changes in the air-conditioned room temperature during low-load operation\*

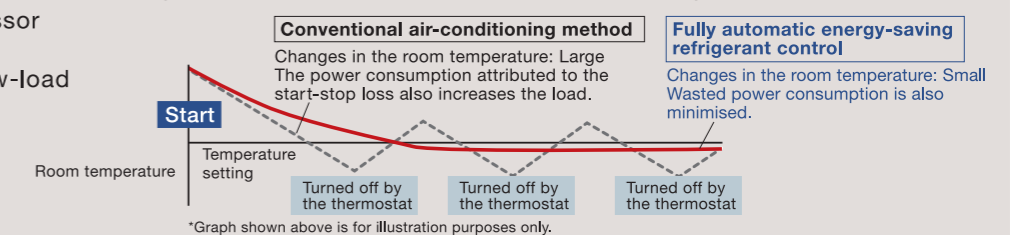

Note:  
 • For the classification of indoor units (VRT smart control and VRT control), refer to page 25-26.  
 • If a system has indoor units subject to both VRT smart and VRT control, the system is operated under VRT control.  
 • If a system has both outdoor-air processing air conditioners and outdoor-air processing type indoor units, VRT smart control and VRT control are disabled.

### Optimum utilisation of VRT Smart Control and VRT Control

Effectiveness can be demonstrated for VRT Smart Control and VRT Control when all the indoor units operate under low load conditions in a similar manner.

Low load conditions are the time when room temperature approaches set temperature. For this reason, please note the following to maximise energy efficiency.

#### When selecting indoor units

Indoor units are installed in a system so that they operate largely under the same conditions. Energy efficiency decreases for the installation patterns shown below.

Example:

- 1) A load imbalance occurs because an indoor unit in the same system is installed near the perimeter of the room or in the vicinity of a room entrance.
- 2) Different operating hours for indoor units.

#### Time of Use

1. Energy efficiency decreases when the set temperature of a specified indoor unit is excessively lowered during cooling operation.
2. The airflow rate setting is set to "Auto" during VRT Smart Control.

## Greater energy savings during low-load operation

### The key to innovative energy savings is to increase efficiency during low-load operation.

Using data gathered from actual operation, Daikin discovered that air conditioning systems operate at a load factor of 50% or less for 80% of their annual operation period.

This inspired us to develop new technologies to enhance energy efficiency during low-load operation. Utilising these technologies, Daikin's new VRV X series raises the standard of energy efficiency.

• Correlation between the load factor for the rated capacity and operation time (in office buildings in Singapore)  
 \* According to a survey by Daikin (based on Air Conditioning Network Service System data)

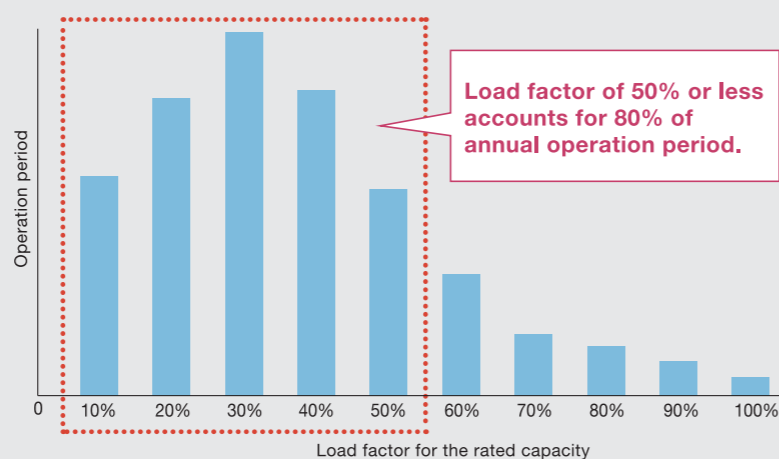

### Higher Coefficient of Performance (COP)

#### COP for 10 HP

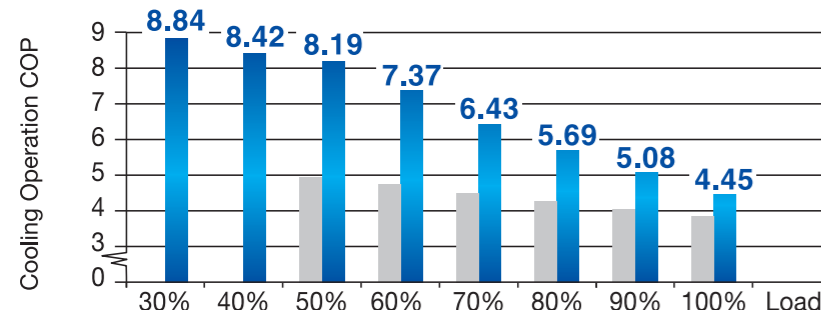

**Annual power consumption 20%\* lower**

\* Simulation conditions :  
 • Location : Bangkok, Thailand  
 • System : Outdoor unit (10 HP) x 1  
 Indoor unit (2 HP, Round Flow with Sensing type) x 5  
 • Operation time : 8:00-20:00 5 days/week  
 • Outdoor units :  
 New model : RXUQ10A (VRV X series)  
 Conventional model : RXQ10T (VRV IV)



\*Cooling operation conditions: Indoor temp. of 27°CDB, 19°CWB, and outdoor temp. of 35°CDB.

## More accurate test operation and stable system

### Efficient automatic test operation

Daikin **VRV X** series incorporates a simplified and efficient test operation function, not only greatly accelerating the installation process, but effectively improving the field setting quality as well.

- Automatically checks the wirings between outdoor units and indoor units to confirm whether there is a defective wiring.
- Confirms piping length to optimise operation.
- Automatically checks whether the stop valve in each outdoor unit is in normal status to ensure the smooth operation of air conditioning system.

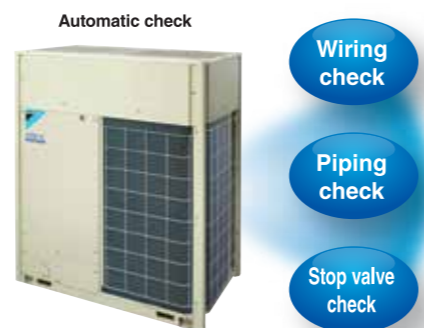

## Simplified commissioning and after-sales service

### Function of information display by luminous digital tube

**VRV X** series utilises 7-segment luminous digital tubes to display system operation information, enabling the operational state to be visually displayed whilst facilitating simplified commissioning and after-sales service.

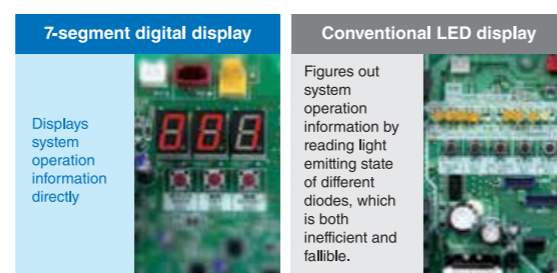

## Advanced control main PC board

### SMT\* packaging technology

- SMT packaging technology adopted by the whole computer control panel improves the anti-clutter performance.
- Protects your computer boards from the adverse effect of sandy and humid weather.

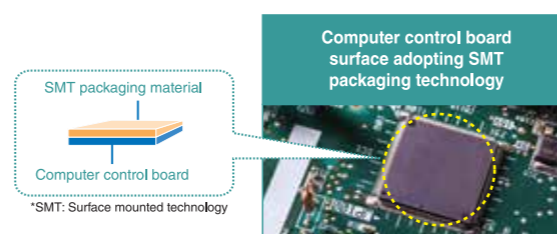

## I-demand function

Limit to power consumption can be set precisely to one of 11 levels. Peak power cut-off can be accomplished according to each user situation.

\*Set on the circuit board of the outdoor unit.

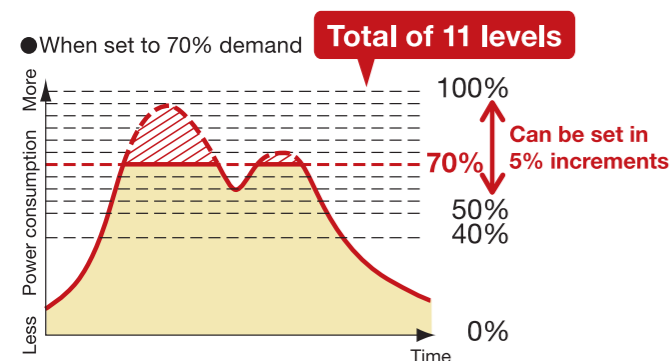

## Wide operation temperature range up to 49°C

The versatile operation range of the **VRV X** series works to reduce limitations on installation locations. The operation temperature range for cooling can be performed with outdoor temperatures as high as 49°C. This enables reliable operation even under high temperature conditions.

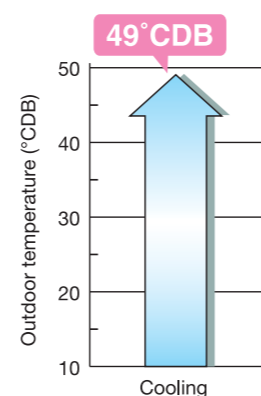

Note: When outdoor temperature falls below 10°C, the thermostat shuts OFF, the outdoor unit stops, and operation switches from cooling to fan operation.

## Automatic sequencing operation

During start-up, Daikin **VRV X** series outdoor unit sequencing operation will be automatically enabled to ensure balance operation of each outdoor unit to improve longevity of equipment and operation stability.

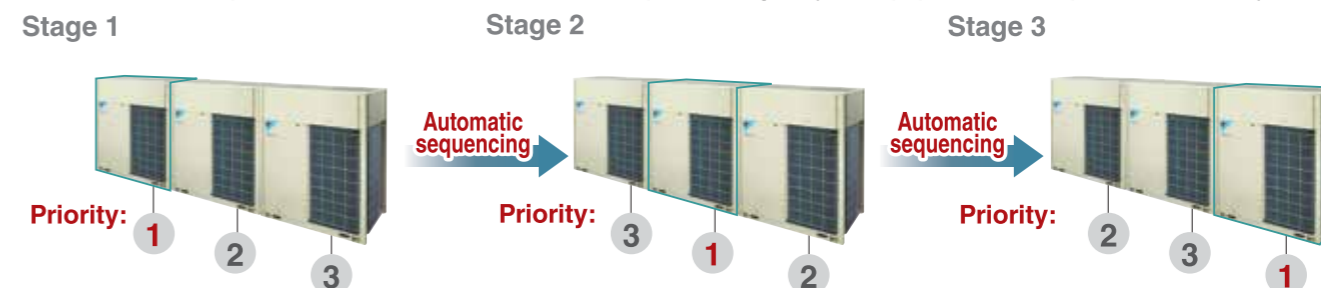

## Double backup operation functions

Daikin **VRV X** series outdoor unit boasts double backup operation functions, which can secure the use of air conditioners in this area to the greatest extent by emergently enabling double backup operation functions even if failure occurs in a set of air conditioning equipment. In the event of a failure, emergency operation can be conveniently enabled to allow the remaining system to operate in a limited fashion.

### Unit backup operation function

If one of the unit in a multiple outdoor system malfunctions, the other outdoor units provide emergency operation until repairs can be made.

\* For systems composed of two or more outdoor units.



### Compressor backup operation function

The outdoor unit is equipped with two compressors. Even if one compressor malfunctions, the other compressor provides emergency operation, reducing the risk of air conditioning shutdown due to compressor failure. (The capacity is saved during backup operation.)

\* For a single outdoor unit system RXUQ14-20AY14 models. On-site settings are required using the printed circuit board of the outdoor unit.

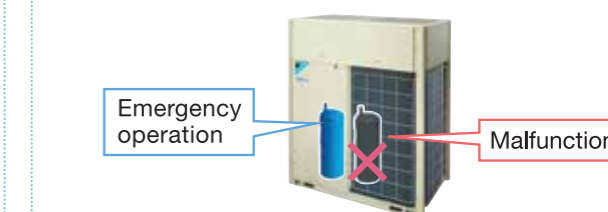

## Ease of Maintenance

**VRV X** series provides maintenance feature\* which allows the shutdown of indoor unit without shutting down the whole **VRV** system. This feature comes in handy during maintenance period as the remaining indoor units continue to operate.

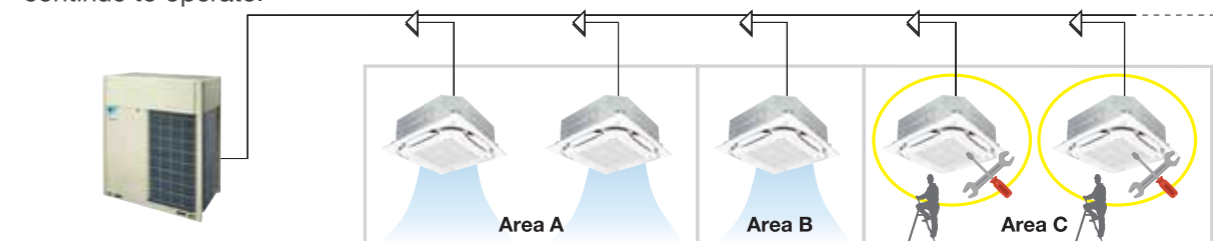

\* Field setting is required. This feature does not apply to residential indoor unit connection and is not applicable for all situations. For more information, please contact Daikin sales office.

## VRV X Series Outdoor Units

The outdoor unit capacity is up to 60 HP (168 kW) in increment of 2 HP.

- VRV X series outdoor unit offers a high capacity of up to 60 HP, responding to the needs of large-sized building.
- The single outdoor unit has only 2 different shapes and dimensions, not only simplifying the design process, but also bringing the system flexibility to a new level.
- With the outdoor unit capacity increased in increment of 2 HP, customers' needs can be precisely met.

### Lineup

CAPACITY (HP)		6	8	10	12	14	16	18	20	22	24	26	28	30	32	34	36	38	40	42	44	46	48	50	52	54	56	58	60	
VRV X SERIES	Single outdoor units	●	●	●	●	●	●	●	●																					
	Double outdoor units				●	●	●	●	●	●	●	●	●	●	●	●	●	●	●	●										
	Triple outdoor units							●	●												●	●	●	●	●	●	●	●	●	●

MODEL		RXUQ6AY14	RXUQ8AY14	RXUQ10AY14	RXUQ12AY14	RXUQ14AY14	RXUQ16AY14	RXUQ18AY14	RXUQ20AY14	RXUQ12AMY14	RXUQ14AMY14	RXUQ16AMY14	RXUQ18AMY14	RXUQ20AMY14	RXUQ18AM1Y14	RXUQ20AM1Y14	RXUQ22AMY14	RXUQ24AMY14	RXUQ26AMY14		
Combination units		—	—	—	—	—	—	—	—	RXUQ6AY14	RXUQ6AY14	RXUQ8AY14	RXUQ8AY14	RXUQ8AY14	RXUQ6AY14	RXUQ6AY14	RXUQ10AY14	RXUQ12AY14	RXUQ12AY14		
Power supply		3-phase 4-wire system, 380-415 V, 50 Hz									3-phase 4-wire system, 380-415 V, 50 Hz										
Cooling capacity	Btu/h	54,600	76,400	95,500	114,000	136,000	154,000	171,000	191,000	109,000	131,000	153,000	172,000	191,000	164,000	186,000	210,000	229,000	251,000		
	kW	16.0	22.4	28.0	33.5	40.0	45.0	50.0	56.0	32.0	38.4	44.8	50.4	55.9	48.0	54.4	61.5	67.0	73.5		
Power consumption	kW	3.23	4.82	6.29	7.81	9.46	11.4	12.8	14.8	6.46	8.05	9.64	11.1	12.6	9.69	11.3	14.1	15.6	17.3		
Capacity control	%	23-100	19-100	13-100	12-100	11-100	9-100		7-100	11-100	10-100	9-100	8-100	7-100	8-100	7-100	6-100				
Dimensions (HxWxD)	mm	1,657x930x765			1,657x1,240x765					(1,657x930x765)+(1,657x930x765)		(1,657x930x765)+(1,657x1,240x765)		(1,657x930x765)+(1,657x930x765)+(1,657x930x765)			(1,657x1,240x765)+(1,657x1,240x765)				
Machine weight	kg	185		215		275		291		185+185		185+215		185+185+185			215+215		215+275		
Sound level	dB(A)	54	56		58	59		62	65	57	58	59		60	59	60		61	62		

MODEL		RXUQ28AY14	RXUQ30AY14	RXUQ32AY14	RXUQ34AY14	RXUQ36AY14	RXUQ38AY14	RXUQ40AY14	RXUQ42AY14	RXUQ44AY14	RXUQ46AY14	RXUQ48AY14	RXUQ50AY14	RXUQ52AY14	RXUQ54AY14	RXUQ56AY14	RXUQ58AY14	RXUQ60AY14	
Combination units		RXUQ12AY14	RXUQ12AY14	RXUQ12AY14	RXUQ14AY14	RXUQ16AY14	RXUQ18AY14	RXUQ20AY14	RXUQ12AY14	RXUQ12AY14	RXUQ12AY14	RXUQ12AY14	RXUQ12AY14	RXUQ12AY14	RXUQ14AY14	RXUQ16AY14	RXUQ18AY14	RXUQ20AY14	
Power supply		3-phase 4-wire system, 380-415 V, 50 Hz							3-phase 4-wire system, 380-415 V, 50 Hz										
Cooling capacity	Btu/h	268,000	285,000	305,000	328,000	345,000	362,000	382,000	399,000	420,000	444,000	461,000	478,000	498,000	519,000	536,000	553,000	573,000	
	kW	78.5	83.5	89.5	96.0	101	106	112	117	123	130	135	140	146	152	157	162	168	
Power consumption	kW	19.2	20.6	22.6	24.3	26.2	27.6	29.6	28.4	30.4	32.1	34.0	35.4	37.4	39.1	41.0	42.4	44.4	
Capacity control	%	5-100			4-100				4-100	3-100							2-100		
Dimensions (HxWxD)	mm	(1,657x1,240x765)+(1,657x1,240x765)								(1,657x1,240x765)+(1,657x1,240x765)+(1,657x1,240x765)									
Machine weight	kg	215+275		215+291		275+291		291+291		215+215+291		215+275+291		215+291+291		275+291+291		291+291+291	
Sound level	dB(A)	62	63	66		67	68	65	66	67		68	69		70				

Note: Specifications are based on the following conditions:

- Cooling: Indoor temp.: 27°DB, 19°WB, Outdoor temp.: 35°DB, Equivalent piping length: 7.5 m, Level difference: 0 m.
- Sound level: Anechoic chamber conversion value, measured at a point 1 m in front of the unit at a height of 1.5 m.

During actual operation, these values are normally somewhat higher as a result of ambient conditions and oil recovery mode.

When there is concern for noise to the surrounding area such as residences, we recommend investigating the installation location and taking soundproofing measures.

# Indoor Unit Lineup

Daikin offers a wide range of indoor units responding to variety of needs of our customers that require air-conditioning solutions.

## VRV indoor units

### Round Flow Cassette with Sensing and Streamer Type

Comfort, energy savings by sensing functions and enhanced maximum efficiency in cleaning



**New** FXFTQ-AV4

### Round Flow Cassette with Streamer Type

360° airflow for improved comfort and enhanced maximum efficiency in cleaning



**New** FXFRQ-AV4

### Round Flow Cassette with Sensing Type

Comfort and energy savings by sensing functions



FXFSQ-AV4

### Round Flow Cassette Type

360° airflow for improved comfort



FXFQ-AV4

### Compact Multi Flow Cassette Type

Quiet, compact, and designed for user comfort



**New** FXZQ-BVM4

### Double Flow Cassette Type

Thin, lightweight, and easy to install in narrow ceiling spaces



**New** FXCQ-BVM4

### Bedroom Duct Type

Suitable for close living spaces such as hotels and condominiums



FXDBQ-AVM4

### Single Flow Cassette Type

Slim design for flexible installation



FXKQ-MAVE4

### Ceiling Mounted Cassette Duct Type

Unprecedented flexibility with Revolutionary air blow concept



FXFDQ-AV4

### Slim Duct (Standard) Type

Slim design, quietness and ideal for drop-ceilings



FXDQ-PDVE(T)4

FXDQ-NDVE(T)4

### Slim Duct (Compact) Type

Slim and compact design for easy and flexible installation



FXDQ-SPV14

### Middle Static Pressure Duct Type

Middle static pressure and slim design allow flexible installations.



FXSQ-PAV4

### Middle-High Static Pressure Duct Type

Middle and high static pressure allows for flexible duct design.



FXMQ-PAV4

### High Static Pressure Duct Type

High static pressure allows for flexible duct design.

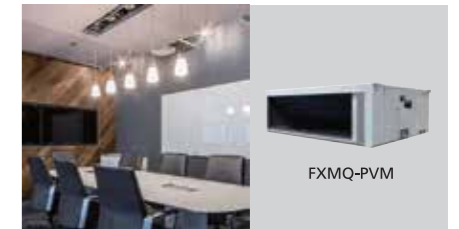

FXMQ-PVM

### Outdoor-Air Processing Unit

Combine fresh air treatment and air conditioning, supplied from a single system.



FXMQ-MFV7

### Outdoor-Air Processing Unit

Improve IAQ with fresh air ventilation and precise room temperature control



**New** FXMQ-BFV24

### Ceiling Suspended Type

Slim body with quiet and wide airflow.



FXHQ-MAV7

**New** FXHQ-BVM4

### Wall Mounted Type

Stylish flat panel design harmonised with your interior décor.



FXAQ-AVM4

### Floor Standing Type / Conceal Floor Standing Type

Suitable for perimeter zone air conditioning



FXLQ-MAVE4

FXNQ-MAVE4

### Floor Standing Duct Type

Large airflow type for large spaces.



FXVQ-NY14

### Clean Room Air Conditioner

Suitable for hospitals and other clean spaces

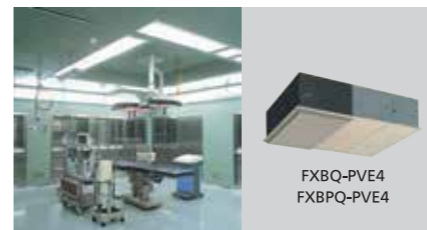

FXBQ-PVE4  
FXBPQ-PVE4

### Air Handling Unit

Integrate your air handling unit in a total solution for large size spaces such as factories and large stores.



AHUR

## Air treatment equipment

### Heat Reclaim Ventilator with DX-Coil

Air quality improvement by introducing fresh outdoor air in the room



VKM-GCVE

### Heat Reclaim Ventilator

Daikin VAM series ensures fresh air intake and energy savings



VAM-HVE

## Ceiling Mounted Cassette (Round Flow with Sensing) Type

**FXFSQ-A**  
Round flow with sensing



## Ceiling Mounted Cassette (Round Flow) Type

**FXFQ-A**  
ROUND FLOW



### Wide variety of decoration panels (Option)

• Designer choice has been given a boost with the increase in number of new types of decoration panels.



### Decoration Panel Lineup (Option)



## Specifications

### Ceiling Mounted Cassette (Round Flow with Sensing) Type

MODEL	FXFSQ25AV4	FXFSQ32AV4	FXFSQ40AV4	FXFSQ50AV4	FXFSQ63AV4	FXFSQ80AV4	FXFSQ100AV4	FXFSQ125AV4	FXFSQ140AV4	
Power supply	1-phase, 220-240 V/220-230 V, 50/60 Hz									
Cooling capacity	Btu/h	9,600	12,300	15,400	19,100	24,200	30,700	38,200	47,800	54,600
Power consumption	kW	0.028		0.035	0.038	0.061	0.092	0.144	0.170	0.194
Casing	Galvanised steel plate									
Sound level (H/HM/M/ML/L)	dB(A)	30/29.5/28.5/28/27		35/29.5/29/28/27	38/35/34.5/29.5/27	38/36/35.5/31.5/28	39/37/36/35.5/31	44/41/38/35/33	45/42.5/39.5/37/35	46/43.5/40.5/38/35
Dimensions (HxWxD)	mm	256x840x840						298x840x840		
Machine weight	kg	19			24	22	25		26	

### Ceiling Mounted Cassette (Round Flow) Type

MODEL	FXFQ25AV4	FXFQ32AV4	FXFQ40AV4	FXFQ50AV4	FXFQ63AV4	FXFQ80AV4	FXFQ100AV4	FXFQ125AV4	FXFQ140AV4	
Power supply	1-phase, 220-240 V/220-230 V, 50/60 Hz									
Cooling capacity	Btu/h	9,600	12,300	15,400	19,100	24,200	30,700	38,200	47,800	54,600
Power consumption	kW	0.029		0.036	0.040	0.063	0.096	0.158	0.178	0.203
Casing	Galvanised steel plate									
Sound level (H/HM/M/ML/L)	dB(A)	30/29.5/28.5/28/27		35/29.5/29/28/27	35/33.5/29.5/28.5/27	36/35.5/31.5/31/28	37/36.5/36/35.5/29.5	43/40.5/37.5/35/33	44/41.5/39/36.5/33	46/43.5/40.5/38/35
Dimensions (HxWxD)	mm	256x840x840						298x840x840		
Machine weight	kg	19			22	25		26		

Note: Specifications are based on the following conditions;

- Cooling: Indoor temp.: 27°CDB, 19°CWB, Outdoor temp.: 35°CDB, Equivalent piping length: 7.5 m, Level difference: 0 m.
  - Capacity of indoor unit is only for reference. Actual capacity of indoor unit is based on the total capacity index. (See Engineering Data Book for details.)
  - Sound level: Anechoic chamber conversion value, measured at a point 1.5 m downward from the unit centre.
- During actual operation, these values are normally somewhat higher as a result of ambient conditions.



## NEW Round Flow Cassette with Sensing and Streamer Round Flow Cassette with Streamer FXFTQ-AV(M)(4)(S), FXFRQ-AV(M)(4)(S)

### Introducing Streamer technology to VRV Indoor unit



Irradiate streamers when the fan and air conditioning operation is stopped. The streamer fumigates the cabin and sterilizes the filter.

Wired remote controller BRC1H62W/K	Model name	
	FXFTQ-A	FXFRQ-A
Streamer function unit	✓	✓
Dual sensors*	✓	×
Sensing sensor low mode*	✓	×
Sensing sensor stop mode*	✓	×
Circulation airflow	×	×
Individual airflow direction control	✓	✓
Switchable 5 step fan speed	✓	✓
Auto airflow function (Draft prevention)*	✓	×
Auto swing	✓	✓
Selectable airflow pattern	×	×
Swing pattern selection	✓	✓
High ceiling application	✓	✓

Note: \*Applicable when sensing panel is installed.

### FEATURES

**FXFTQ : Round Flow Cassette with Sensing and Streamer**  
**FXFRQ : Round Flow Cassette with Streamer**

- Remarks:**
- 1) Only the remote controller BRC1H62W(K) can be connected for ON / OFF operation of the streamer.
  - 2) Streamer function operates when the fan stops after the air conditioning operation is stopped. The maximum operation of streamer is 180 minutes per day. (This function is available only when the remote controller BRC1H62W(K) is connected.)



### Specifications

MODEL NAME		FXFTQ25A	FXFTQ32A	FXFTQ40A	FXFTQ50A	FXFTQ63A	FXFTQ80A	FXFTQ100A	FXFTQ125A	FXFTQ140A	
Power supply		VM: 1-phase, 220-240 V/220-230 V, 50/60 Hz or V4V5: 1-phase, 220 V, 50 Hz									
Cooling capacity	Btu/h	9,600	12,300	15,400	19,100	24,200	30,700	38,200	47,800	54,600	
	kW	2.8	3.6	4.5	5.6	7.1	9.0	11.2	14.0	16.0	
Heating capacity	Btu/h	10,900	13,600	17,100	21,500	27,300	34,100	42,700	54,600		
	kW	3.2	4.0	5.0	6.3	8.0	10.0	12.5	16.0		
Power consumption	Cooling	0.028		0.035	0.056	0.061	0.092	0.164	0.170	0.194	
	Heating	0.026		0.034	0.056	0.060	0.092	0.144	0.159	0.183	
Casing		Galvanised steel plate									
Airflow rate (H/MM/M/ML/L)	m <sup>3</sup> /min	13/12.5/11.5/11/10	17/13.5/12.5/12/11	23/20.5/19/14.5/11	23.5/21/20/16/13.5	24.5/22/20.5/20/15	33.5/30.5/27/23.5/21	34.5/31.5/28.5/25.5/23	35.5/32.5/29.5/26.5/23		
	cfm	459/441/406/388/353	600/477/441/424/388	812/724/671/512/388	830/741/706/565/477	865/777/724/706/530	1,183/1,077/953/830/741	1,218/1,112/1,006/900/812	1,253/1,147/1,041/935/812		
Sound level (H/MM/M/ML/L)	dB(A)	30/29.5/28.5/28/27	35/29.5/29/28/27	38/35/34.5/29.5/27	38/36/35.5/31.5/28	39/37/36/35.5/31	44/41/38/35/33	45/42.5/39.5/37/35	46/43.5/40.5/38/35		
Dimensions (HxWxD)	mm	256x840x840							298x840x840		
Machine weight	kg	19			24		22		25	26	
Piping connections	Liquid (Flare)	φ 6.4				φ 9.5					
	Gas (Flare)	φ 12.7				φ 15.9					
	Drain	VMV4: VP25 (External Dia. 32/Internal Dia. 25) or VS: External Dia. 34/Internal Dia. 25									

MODEL NAME		FXFRQ25A	FXFRQ32A	FXFRQ40A	FXFRQ50A	FXFRQ63A	FXFRQ80A	FXFRQ100A	FXFRQ125A	FXFRQ140A	
Power supply		VM: 1-phase, 220-240 V/220-230 V, 50/60 Hz or V4V5: 1-phase, 220 V, 50 Hz									
Cooling capacity	Btu/h	9,600	12,300	15,400	19,100	24,200	30,700	38,200	47,800	54,600	
	kW	2.8	3.6	4.5	5.6	7.1	9.0	11.2	14.0	16.0	
Heating capacity	Btu/h	10,900	13,600	17,100	21,500	27,300	34,100	42,700	47,800	54,600	
	kW	3.2	4.0	5.0	6.3	8.0	10.0	12.5	14.0	16.0	
Power consumption	Cooling	0.029		0.036	0.040	0.063	0.096	0.158	0.178	0.203	
	Heating	0.027		0.036	0.040	0.063	0.096	0.150	0.166	0.191	
Casing		Galvanised steel plate									
Airflow rate (H/MM/M/ML/L)	m <sup>3</sup> /min	13/12.5/11.5/11/10	17/13.5/13/12/11	18/17/13.5/12.5/11	21/20/16/15/13.5	22.5/21.5/21/20/15	32/29/26/23/21	33/30.5/28/25.5/21	35.5/32.5/29.5/26.5/23		
	cfm	459/441/406/388/353	600/477/459/424/388	635/600/477/441/388	741/706/565/530/477	794/759/741/706/530	1,130/1,024/918/812/741	1,165/1,077/988/900/741	1,253/1,147/1,041/935/812		
Sound level (H/MM/M/ML/L)	dB(A)	30/29.5/28.5/28/27	35/29.5/29/28/27	35/33.5/29.5/28.5/27	36/35.5/31.5/31/28	37/36.5/36/35.5/29.5	43/40.5/37.5/35/33	44/41.5/39/36.5/33	46/43.5/40.5/38/35		
Dimensions (HxWxD)	mm	256x840x840							298x840x840		
Machine weight	kg	19			22		25		26		
Piping connections	Liquid (Flare)	φ 6.4				φ 9.5					
	Gas (Flare)	φ 12.7				φ 15.9					
	Drain	VMV4: VP25 (External Dia. 32/Internal Dia. 25) or VS: External Dia. 34/Internal Dia. 25									

Notes: Specifications are based on the following conditions:  
 • Cooling: Indoor temp.: 27°CDB, 19°CWB, Outdoor temp.: 35°CDB, Equivalent piping length: 7.5 m, Height difference: 0 m.  
 • Heating: Indoor temp.: 20°CDB, Outdoor temp.: 7°CDB, 6°CWB, Equivalent piping length: 7.5 m, Height difference: 0 m.  
 • Capacity of indoor unit is only for reference. Actual capacity of indoor unit is based on the total capacity index. (See Engineering Data Book for details.)  
 • Sound level: Anechoic chamber conversion value, measured at a point 1.5 m downward from the unit centre.  
 During actual operation, these values are normally somewhat higher as a result of ambient conditions.

### Option list

Name of option	MODEL NAME	FXFTQ25,32,40,50,63,80A	FXFTQ100,125,140A	FXFRQ25,32,40,50,63,80A	FXFRQ100,125,140A
Standard panel with sensing	Fresh white	BYCQ125EEF		-	
	Black	BYCQ125EEK		-	
Standard panel	Fresh white	BYCQ125EAF		BYCQ125EAF	
	Black	BYCQ125EAK		BYCQ125EAK	
Panel spacer		KDB55J160F		KDB55J160F	
Fresh air intake kit	Chamber type 1,2,4	Without T-duct joint	KDDP55C160 [Components: KDDP55C160-1, KDDP55C160-2]	KDDP55C160 [Components: KDDP55C160-1, KDDP55C160-2]	
	With T-duct joint		KDDP55C160K [Components: KDDP55C160-1, KDDP55C160K2]	KDDP55C160K [Components: KDDP55C160-1, KDDP55C160K2]	
	Direct installation type 3		KDDP55X160A	KDDP55X160A	
Replacement long-life filter		KAF5511D160		KAF5511D160	
Branch duct chamber		KDJP55C80	KDJP55C160	KDJP55C80	KDJP55C160
Insulation kit for high humidity 5		KDTP55K80A	KDTP55K160A	KDTP55K80A	KDTP55K160A
Stylish remote controller 6		BRC1H62W/BRC1H62K		BRC1H62W/BRC1H62K	
Adaptor for wiring (operation status output) 7		BRP11B62		BRP11B62	
Digital input adaptor 7		BRP7A52		BRP7A52	
Wiring adaptor for electrical appendices 7		KRP4AA53		KRP4AA53	
Installation box for adaptor PCB		KRP1H98A		KRP1H98A	
Remote sensor		BRC501A-5		BRC501A-5	
External control adaptor for outdoor unit 7		DTA104A62		DTA104A62	
Multi tenant for indoor unit (24V free type) 7		BRP114A61		BRP114A61	
Multi tenant for unit booster (24V free type)		BRP114A63		BRP114A63	

Notes: 1. When installing a fresh air intake kit (chamber type), two air outlet corners are closed.  
 2. It is recommended that the volume of outdoor air introduced through the kit is limited to 10% of the maximum airflow rate of the indoor unit. Introducing higher quantities will increase the operating sound and may also influence temperature sensing.  
 3. The volume of fresh air for direct installation type is approximately 1% of the indoor unit airflow. The chamber type is recommended when more fresh air is necessary.  
 4. Please order using the names of both components instead of set name.  
 5. Please use in case temperature/humidity inside ceiling may get over 30°C, 80% RH.  
 6. Wiring for wired remote controller should be obtained locally.  
 7. Installation box for adaptor PCB (KRP1H98A) is necessary.

## Compact Multi Flow Cassette Type

**New FXZQ-B**  
 Quiet, compact, and designed for user comfort



### Compact & elegant design

- Fully-flat integration in standard architectural ceiling tiles, leaving only 8 mm
- Remarkable blend of iconic design and engineering excellence with an elegant finish in white
- The newly designed panel integrates fully within one ceiling tile enabling lights, speakers and sprinklers to be installed in the adjoining ceiling tiles.

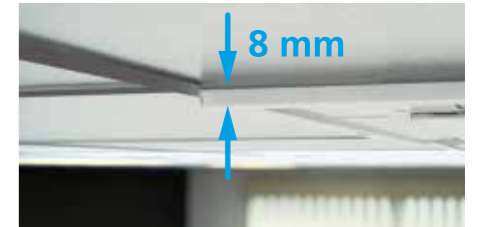

### Efficiency & comfort

#### Dual sensors (Option)

- Two optional intelligent sensors improve energy efficiency and comfort.
- An optional presence and floor sensor kit can be fitted to the cassette for draught prevention, energy-saving operation and to provide optimal control of airflow.

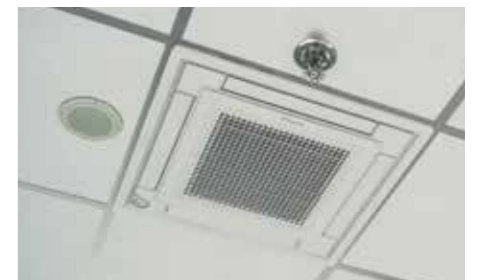

#### Individual airflow direction control\*

- Airflow direction can be individually adjusted for each air discharge outlet to deliver optimal air distribution.



\*Applicable when wired remote controller BRC1E63 or BRC1H63W(K) is used.

#### Auto swing (up/down)

- Possibility to select automatic vertical moving of the air discharge flaps for efficient air and temperature distribution throughout the room.

### Cleanliness

#### New Streamer filter clean unit (Option)

Daikin Streamer technology enhances maximum efficiency in cleaning, which uses powerful decomposition properties to decompose substances captured by the filter for better air quality.



Remarks:  
 1) Only the stylish remote controller BRC1H63W(K) can be connected for ON/OFF operation of the streamer.  
 2) The Streamer function operates only when the fan and air conditioning operation are stopped. The maximum operation of Streamer is 180 minutes per day.



BAPW55A61

#### Ceiling soiling prevention

- Prevents air from blowing against the ceiling to prevent ceiling stains.



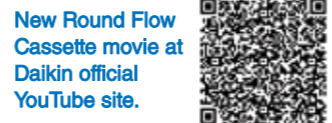

## Ceiling Mounted Cassette (Compact Multi Flow) Type **FXZQ-BVM4**

Quiet, compact, and designed for user comfort

### Specifications

MODEL		FXZQ20BVM4	FXZQ25BVM4	FXZQ32BVM4	FXZQ40BVM4	FXZQ50BVM4	
Power supply		1-phase, 220-240 V/220 V, 50/60 Hz					
Cooling capacity	Btu/h	7,500	9,600	12,300	15,400	19,100	
	kW	2.2	2.8	3.6	4.5	5.6	
Power consumption	kW	0.043		0.045	0.059	0.092	
Casing		Galvanised steel plate					
Sound level (H/L)	230 V, 50 Hz-240 V, 50 Hz	dB(A)	32.0/29.5/25.5	33.0/30.0/25.5	33.5/30.0/26.0	37.0/32.0/26.0	43.0/40.0/33.0
Dimensions (HxWxD)		mm	260x575x575				
Machine weight		kg	15.5	15.5	16.5	16.5	18.5

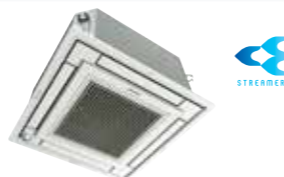

## Ceiling Mounted Cassette (Double Flow) Type **FXCQ-BVM4**

Thin, lightweight, and easy to install in narrow ceiling spaces

### Specifications

MODEL		FXCQ20BVM4	FXCQ25BVM4	FXCQ32BVM4	FXCQ40BVM4	FXCQ50BVM4	FXCQ63BVM4	FXCQ80BVM4	FXCQ125BVM4	
Power supply		1-phase, 220-240 V/220 V, 50/60 Hz								
Cooling capacity	Btu/h	7,500	9,600	12,300	15,400	19,100	24,200	30,700	47,800	
	kW	2.2	2.8	3.6	4.5	5.6	7.1	9.0	14.0	
Power consumption	kW	0.031	0.039	0.039	0.041	0.059	0.063	0.090	0.149	
Casing		Galvanised steel plate								
Sound level (H/L)	220 V	dB(A)	32/28	34/29	34/30	36/31	37/31	39/32	42/33	46/38
Dimensions (HxWxD)		mm	305x775x620	305x775x620	305x775x620	305x990x620	305x990x620	305x1,175x620	305x1,445x620	305x1,445x620
Machine weight		kg	19.0	19.0	19.0	19.0	22.0	25.0	33.0	38.0



## Ceiling Mounted Cassette Corner Type **FXKQ-MA**

Slim design for flexible installation

### Specifications

MODEL		FXKQ25MAVE4	FXKQ32MAVE4	FXKQ40MAVE4	FXKQ63MAVE4	
Power supply		1-phase, 220-240 V/220 V, 50/60 Hz				
Cooling capacity	Btu/h	9,600	12,300	15,400	24,200	
Power consumption	kW	0.066		0.076	0.105	
Sound level (H/L)	220 V	dB(A)		38/33	40/34	42/37
	240 V	dB(A)		40/35	42/36	44/39
Dimensions (HxWxD)		mm			215X1,110X710	215X1,310X710
Machine weight		kg			31	34



Note: Specifications are based on the following conditions:  
 •Cooling: Indoor temp.: 27°CDB, 19°CWB, Outdoor temp.: 35°CDB, Equivalent piping length: 7.5 m, Level difference: 0 m.  
 •Capacity of indoor unit is only for reference. Actual capacity of indoor unit is based on the total capacity index. (See Engineering Data Book for details.)  
 •Sound level: Anechoic chamber conversion value, measured at a point 1 m in front of the unit and 1 m downward. During actual operation, these values are normally somewhat higher as a result of ambient conditions.

## Slim Ceiling Mounted Duct Type (Standard Series) **FXDQ-PD / ND**

Slim design, quietness and static pressure switching



### Specifications

MODEL	with drain pump	FXDQ20PDVE4	FXDQ25PDVE4	FXDQ32PDVE4	FXDQ40NDVE4	FXDQ50NDVE4	FXDQ63NDVE4	
	without drain pump	FXDQ20PDVET4	FXDQ25PDVET4	FXDQ32PDVET4	FXDQ40NDVET4	FXDQ50NDVET4	FXDQ63NDVET4	
Power supply		1-phase, 220-240 V/220 V, 50/60 Hz						
Cooling capacity	Btu/h	7,500	9,600	12,300	15,400	19,100	24,200	
Power consumption (FXDQ-PDVE) *1	kW	0.086	0.086	0.089	0.160	0.165	0.181	
Power consumption (FXDQ-PDVET) *1	kW	0.067	0.067	0.070	0.147	0.152	0.168	
External static pressure	Pa	30-10*2			44-15*2			
Sound level (HH/H/L)*1*3	dB(A)	28/26/23		28/26/24	30/28/26	33/30/27	33/31/29	
Dimensions (HxWxD)		mm	200x700x620	200x700x620	200x700x620	200x900x620	200x900x620	200x1,100x620
Machine weight		kg	23	23	23	27	28	31

Note: Specifications are based on the following conditions:  
 •Cooling: Indoor temp.: 27°CDB, 19°CWB, Outdoor temp.: 35°CDB, Equivalent piping length: 7.5 m, Level difference: 0 m.  
 •Capacity of indoor unit is only for reference. Actual capacity of indoor unit is based on the total capacity index. (See Engineering Data Book for details.)  
 •Sound level: Anechoic chamber conversion value, measured at a point 1.5 m downward from the unit centre.  
 During actual operation, these values are normally somewhat higher as a result of ambient conditions.  
 \*1 : Values are based on the following conditions: FXDQ-PD: external static pressure of 10 Pa; FXDQ-ND: external static pressure of 15 Pa.  
 \*2 : External static pressure is changeable to set by the remote controller. This pressure means "High static pressure - Standard". (Factory setting is 10 Pa for FXDQ-PD models and 15 Pa for FXDQ-ND models.)  
 \*3 : The values of operation sound level represent those for rear-suction operation. Sound level values for bottom-suction operation can be obtained by adding 5 dB(A).

## Slim Ceiling Mounted Duct Type (Compact Series) **FXDQ-SP**

Slim and compact design for easy and flexible installation



### Specifications

MODEL		FXDQ20SPV14	FXDQ25SPV14	FXDQ32SPV14	FXDQ40SPV14	FXDQ50SPV14	FXDQ63SPV14
Power supply		1-phase, 220-240 V, 50 Hz					
Cooling capacity	Btu/h	7,500	9,600	12,300	15,400	19,100	24,200
Power consumption *1	kW	0.072	0.075	0.078	0.180	0.180	0.196
Airflow rate (HH/H/L)	m³/min	8.7/7.6/6.5	9.0/8.0/7.0	10.0/9.0/8.0	15.0/13.0/10.5		20.0/16.0/12.5
	cfm	307/268/229	318/282/247	353/318/282	530/459/371		706/565/441
External static pressure	Pa	30-10*2		50-20*2			40-20*2
Sound level (HH/H/L)*1*3	dB(A)	33/31/29		34/32/30	35/33/31		37/35/33
Dimensions (HxWxD)		mm			200x700x450	200x900x450	200x1,100x450
Machine weight		kg			17	20	23

Note: Specifications are based on the following conditions:  
 •Cooling: Indoor temp.: 27°CDB, 19°CWB, Outdoor temp.: 35°CDB, Equivalent piping length: 7.5 m, Level difference: 0 m.  
 •Capacity of indoor unit is only for reference. Actual capacity of indoor unit is based on the total capacity index. (See Engineering Data Book for details.)  
 •Sound level: Anechoic chamber conversion value, measured at a point 1.5 m downward from the unit centre.  
 During actual operation, these values are normally somewhat higher as a result of ambient conditions.  
 \*1 : Values are based on the following conditions: FXDQ20-32SP: external static pressure of 10 Pa; FXDQ40-63SP: external static pressure of 20 Pa.  
 \*2 : External static pressure is changeable to set by the remote controller. This pressure means "High static pressure - Standard". (Factory setting is 10 Pa for FXDQ20-32SP models and 20 Pa for FXDQ40-63SP models.)  
 \*3 : The values of operation sound level represent those for rear-suction operation. Sound level values for bottom-suction operation can be obtained by adding 5 dB(A).

## Ceiling Mounted Duct Type

FXMQ-PA / MA / P

Middle and high static pressure allows for flexible duct design



### Specifications

MODEL		FXMQ20PAV4	FXMQ25PAV4	FXMQ32PAV4	FXMQ40PAV4	FXMQ50PAV4
Power supply		1-phase, 220-240 V/220 V, 50/60 Hz				
Cooling capacity	Btu/h	7,500	9,600	12,300	15,400	19,100
Power consumption	kW	0.056 *1	0.056 *1	0.060 *1	0.151 *1	0.128 *1
Airflow rate (HH/H/L)	m <sup>3</sup> /min	9/7.5/6.5	9/7.5/6.5	9.5/8/7	16/13/11	18/16.5/15
	cfm	318/265/230	318/265/230	335/282/247	565/459/388	635/582/530
External static pressure	Pa	30-100 (50) *2	30-100 (50) *2	30-100 (50) *2	30-160 (100) *2	50-200 (100) *2
Sound level (HH/H/L)	dB(A)	33/31/29	33/31/29	34/32/30	39/37/35	41/39/37
Dimensions (HxWxD)	mm	300x550x700	300x550x700	300x550x700	300x700x700	300x1,000x700
Machine weight	kg	25	25	25	27	35

MODEL		FXMQ63PAV4	FXMQ80PAV4	FXMQ100PAV4	FXMQ125PAV4	FXMQ140PAV4
Power supply		1-phase, 220-240 V/220 V, 50/60 Hz				
Cooling capacity	Btu/h	24,200	30,700	38,200	47,800	54,600
Power consumption	kW	0.138 *1	0.185 *1	0.215 *1	0.284 *1	0.405 *1
Airflow rate (HH/H/L)	m <sup>3</sup> /min	19.5/17.5/16	25/22.5/20	32/27/23	39/33/28	46/39/32
	cfm	688/618/565	883/794/706	1,130/953/812	1,377/1,165/988	1,624/1,377/1,130
External static pressure	Pa	50-200 (100) *2	50-200 (100) *2	50-200 (100) *2	50-200 (100) *2	50-140 (100) *2
Sound level (HH/H/L)	dB(A)	42/40/38	43/41/39	43/41/39	44/42/40	46/45/43
Dimensions (HxWxD)	mm	300x1,000x700	300x1,000x700	300x1,400x700	300x1,400x700	300x1,400x700
Machine weight	kg	35	35	45	45	46

Note: Specifications are based on the following conditions:  
 • Cooling: Indoor temp.: 27°CDB, 19°CWB, Outdoor temp.: 35°CDB, Equivalent piping length: 7.5 m, Level difference: 0 m.  
 • Capacity of indoor unit is only for reference. Actual capacity of indoor unit is based on the total capacity index. (See Engineering Data Book for details.)  
 • Sound level: Anechoic chamber conversion value, measured at a point 1.5 m downward from the unit centre.  
 During actual operation, these values are normally somewhat higher as a result of ambient conditions.  
 \*1: Power consumption values are based on conditions of rated external static pressure.  
 \*2: External static pressure can be modified using a remote controller that offers seven (FXMQ20-32PA), thirteen (FXMQ40PA), fourteen (FXMQ50-125PA) or ten (FXMQ140PA) levels of control. These values indicate the lowest and highest possible static pressures. The standard static pressure is 50 Pa for FXMQ20-32PA and 100 Pa for FXMQ40-140PA.

High static pressure allows for flexible duct design



FXMQ200-250PVM4

### Specifications

MODEL		FXMQ200MAV4	FXMQ250MAV4	FXMQ200PVM	FXMQ250PVM
Power supply		1-phase, 220-240 V/220 V, 50/60 Hz			
Cooling capacity	Btu/h	76,400	95,500	76,400	95,500
Power consumption	kW	1.294 *1	1.465 *1	0.55 *1	0.67 *1
Airflow rate (H/L)	m <sup>3</sup> /min	58/50	72/62	61/50	71/58
	cfm	2,047/1,765	2,542/2,189	2,153/1,765	2,506/2,047
External static pressure	Pa	132-221 *2	191-270 *2	50-250 (150) *2	50-250 (150) *2
* Sound level (H/L)	220 V	48/45	48/45	38/35	40/37
	240 V	49/46	49/46	-	-
Dimensions (HxWxD)	mm	470x1,380x1,100	470x1,380x1,100	470x1,490x1,100	470x1,490x1,100
Machine weight	kg	137	137	95	105

Note: Specifications are based on the following conditions:  
 • Cooling: Indoor temp.: 27°CDB, 19°CWB, Outdoor temp.: 35°CDB, Equivalent piping length: 7.5 m, Level difference: 0 m.  
 • Capacity of indoor unit is only for reference. Actual capacity of indoor unit is based on the total capacity index. (See Engineering Data Book for details.)  
 • Sound level: (FXMQ-MA) Anechoic chamber conversion value, measured at a point 1.5 m downward from the unit centre.  
 During actual operation, these values are normally somewhat higher as a result of ambient conditions.  
 1: Power consumption values are based on conditions of standard external static pressure.  
 2: External static pressure is changeable to change over the connectors inside electrical box, this pressure means "Standard-High static pressure".

## Middle Static Pressure Ceiling Mounted Duct Type

FXSQ-PA

Middle external static pressure and slim design allow flexible installations



### Specifications

MODEL		FXSQ20PAV4	FXSQ25PAV4	FXSQ32PAV4	FXSQ40PAV4	FXSQ50PAV4
Power supply		1-phase, 220-240 V/220 V, 50/60 Hz				
Cooling capacity	Btu/h	7,500	9,600	12,300	15,400	19,100
Power consumption	kW	0.058 *1	0.058 *1	0.066 *1	0.101 *1	0.075 *1
Airflow rate (H/M/L)	m <sup>3</sup> /min	9/7.5/6.5	9/7.5/6.5	9.5/8/7	15/12.5/10.5	17/14.5/11.5
	cfm	318/265/230	318/265/230	335/282/247	530/441/371	600/512/406
External static pressure	Pa	30-150 (50) *2				50-150 (50) *2
Sound level (H/M/L)	dB(A)	33/30/28		34/32/30	36/33/30	34/32/29
Dimensions (HxWxD)	mm	245x550x800			245x700x800	245x1,000x800
Machine weight	kg	25		27	35	

MODEL		FXSQ63PAV4	FXSQ80PAV4	FXSQ100PAV4	FXSQ125PAV4	FXSQ140PAV4
Power supply		1-phase, 220-240 V/220 V, 50/60 Hz				
Cooling capacity	Btu/h	24,200	30,700	38,200	47,800	54,600
Power consumption	kW	0.106 *1	0.126 *1	0.151 *1	0.206 *1	0.222 *1
Airflow rate (H/M/L)	m <sup>3</sup> /min	21/17.5/14.5	23/19.5/16	32/27/22.5	37/31.5/26	39/33.5/28
	cfm	741/618/512	812/688/565	1,130/953/794	1,306/1,112/918	1,377/1,183/988
External static pressure	Pa	50-150 (50) *2				50-140 (50) *2
Sound level (H/M/L)	dB(A)	36/32/29	37.5/34/30	39/35/32	42/38.5/35	43/40/36
Dimensions (HxWxD)	mm	245x1,000x800		245x1,400x800		245x1,550x800
Machine weight	kg	35	37	46	47	52

Note: Specifications are based on the following conditions:  
 • Cooling: Indoor temp.: 27°CDB, 19°CWB, Outdoor temp.: 35°CDB, Equivalent piping length: 7.5 m, Level difference: 0 m.  
 • Capacity of indoor unit is only for reference. Actual capacity of indoor unit is based on the total capacity index. (See Engineering Data Book for details.)  
 • Sound level: Anechoic chamber conversion value, measured at a point 1.5 m downward from the unit centre.  
 During actual operation, these values are normally somewhat higher as a result of ambient conditions.  
 \*1: Power consumption values are based on conditions of rated external static pressure.  
 \*2: External static pressure can be modified using a remote controller that offers thirteen (FXSQ20-40PA), eleven (FXSQ50-125PA) or ten (FXSQ140PA) levels of control. These values indicate the lowest and highest possible static pressures. The rated static pressure is 50 Pa.

## Wall Mounted Type

FXAQ-AVM

Stylish flat panel design harmonised with your interior décor



### Specifications

MODEL		FXAQ20AVM(4)(S)	FXAQ25AVM(4)(S)	FXAQ32AVM(4)(S)	FXAQ40AVM(4)(S)	FXAQ50AVM(4)(S)	FXAQ63AVM(4)(S)	
Power supply		VM: 1-phase, 220-240 V/220-230 V, 50/60 Hz VM4, VMS: 1-phase, 220 V, 50 Hz						
Cooling capacity	Btu/h	7,500	9,600	12,300	15,400	19,100	24,200	
Power consumption	kW	0.040			0.050	0.060	0.100	
Airflow rate (H/L)	m <sup>3</sup> /min	9.1/7.0	9.4/7.0	9.8/7.0	12.2/9.7	15.0/12.0	19.0/14.0	
	cfm	321/247	332/247	346/247	431/342	530/424	671/494	
Sound level (H/L)	dB(A)	33.0/28.5	35.0/28.5	37.5/28.5	37.0/33.5	41.0/35.5	46.5/38.5	
Dimensions (HxWxD)	mm	290x795x266				290x1,050x269		
Machine weight	kg	12.0				15.0		

Note: Specifications are based on the following conditions:  
 • Cooling: Indoor temp.: 27°CDB, 19°CWB, Outdoor temp.: 35°CDB, Equivalent piping length: 7.5 m, Level difference: 0 m.  
 • Heating: Indoor temp.: 20°CDB, Outdoor temp.: 7°CDB, 6°CWB, Equivalent piping length: 7.5 m, Level difference: 0 m.  
 • Capacity of indoor unit is only for reference. Actual capacity of indoor unit is based on the total capacity index. (See Engineering Data Book for details.)  
 • Sound level: Anechoic chamber conversion value, measured at a point 1 m in front of the unit and 1 m downward.  
 During actual operation, these values are normally somewhat higher as a result of ambient conditions.

## Ceiling Suspended Type

FXHQ-MA / B

Slim body with quiet and wide airflow



### Specifications

MODEL		FXHQ32MAV7	FXHQ63MAV7	FXHQ100MAV7	FXHQ125BVM4	FXHQ140BVM4
Power supply		1-phase, 220-240 V/220 V, 50/60 Hz				
Cooling capacity	Btu/h	12,300	24,200	38,200	48,000	52,900
Power consumption	kW	0.111	0.115	0.135	0.168	0.181
Airflow rate (H/L)	m <sup>3</sup> /min	12/10	17.5/14	25/19.5	34/20	36/20
	cfm	424/353	618/494	883/688	1,200/706	1,271/706
Sound level (H/L)	dB(A)	36/31	39/34	45/37	46/37	48/37
Dimensions (HxWxD)	mm	195x960x680	195x1,160x680	195x1,400x680	235x1,590x690	235x1,590x690
Machine weight	kg	24.0	28.0	33.0	39.0	

Note: Specifications are based on the following conditions:  
 • Cooling: Indoor temp.: 27°CDB, 19°CWB, Outdoor temp.: 35°CDB, Equivalent piping length: 7.5 m, Level difference: 0 m.  
 • Capacity of indoor unit is only for reference. Actual capacity of indoor unit is based on the total capacity index. (See Engineering Data Book for details.)  
 • Sound level: Anechoic chamber conversion value, measured at a point 1 m in front of the unit and 1 m downward. During actual operation, these values are normally somewhat higher as a result of ambient conditions.

## Floor Standing Type

FXLQ-MA

Suitable for perimeter zone air conditioning



### Specifications

MODEL		FXLQ20MAVE4	FXLQ25MAVE4	FXLQ32MAVE4	FXLQ40MAVE4	FXLQ50MAVE4	FXLQ63MAVE4
Power supply		1-phase, 220-240 V/220 V, 50/60 Hz					
Cooling capacity	Btu/h	7,500	9,600	12,300	15,400	19,100	24,200
Power consumption	kW	0.049	0.049	0.090	0.090	0.110	0.110
Airflow rate (H/L)	m <sup>3</sup> /min	7/6	7/6	8/6	11/8.5	14/11	16/12
	cfm	247/212	247/212	282/212	388/300	494/388	565/424
Sound level (H/L)	220 V	35/32	35/32	35/32	38/33	39/34	40/35
	240 V	37/34	37/34	37/34	40/35	41/36	42/37
Dimensions (HxWxD)	mm	600x1,000x222	600x1,000x222	600x1,140x222	600x1,140x222	600x1,420x222	600x1,420x222
Machine weight	kg	25.0	25.0	30.0	30.0	36.0	36.0

Note: Specifications are based on the following conditions:  
 • Cooling: Indoor temp.: 27°CDB, 19°CWB, Outdoor temp.: 35°CDB, Equivalent piping length: 7.5 m, Level difference: 0 m.  
 • Capacity of indoor unit is only for reference. Actual capacity of indoor unit is based on the total capacity index. (See Engineering Data Book for details.)  
 • Sound level: Anechoic chamber conversion value, measured at a point 1.5 m in front of the unit at a height of 1.5 m. During actual operation, these values are normally somewhat higher as a result of ambient conditions.

## Ceiling Mounted Cassette Duct Type

FXFDQ-AV4

Unprecedented Flexibility with Revolutionary Air Blow Concept



### Specifications

MODEL		FXFDQ63AV4	FXFDQ80AV4	FXFDQ100AV4	FXFDQ125AV4
Power supply		1-phase, 220 V, 50 Hz			
Cooling capacity	Btu/h	24,200	30,700	38,200	47,800
Power consumption	kW	0.063	0.096	0.158	0.178
Airflow rate (H/M/L)	m <sup>3</sup> /min	21/20/16/15/13.5	22.5/21.5/21/20/15	32/29/26/23/21	33/30.5/28/25.5/21
	cfm	741/706/565/530/477	794/759/741/706/530	1,130/1,024/918/812/741	1,165/1,077/988/900/741
Sound level (H/M/L)	dB(A)	40/38.5/37/35.5/34	43/41.5/40/38.5/37	46.5/45/43.5/42/40.5	46.5/45/43.5/42/40.5
Dimensions (HxWxD)	mm	298x840x840			
Machine weight	kg	26			

Note: Specifications are based on the following conditions:  
 • Cooling: Indoor temp.: 27°CDB, 19°CWB, Outdoor temp.: 35°CDB, Equivalent piping length: 7.5 m, Level difference: 0 m.  
 • Capacity of indoor unit is only for reference. Actual capacity of indoor unit is based on the total capacity index. (See Engineering Data Book for details.)  
 • Sound level: (FXUQ-A) Anechoic chamber conversion value, measured at a point 1 m in front of the unit and 1 m downward. During actual operation, these values are normally somewhat higher as a result of ambient conditions.  
 1: Power consumption values are based on conditions of standard external static pressure.  
 2: External static pressure is changeable to change over the connectors inside electrical box, this pressure means "Standard-High static pressure".

## Floor Standing Duct Type

FXVQ-N

Large airflow type for large spaces. Flexible interior design for each tenant.



### Specifications

MODEL		FXVQ125NY14	FXVQ200NY14	FXVQ250NY14	FXVQ400NY14	FXVQ500NY14	
Power supply		3-phase 4-wire system, 380-415 V, 50 Hz					
Cooling capacity	Btu/h	47,800	76,400	95,500	154,000	191,000	
		0.53	1.33	1.61	3.97	2.62	
Dimensions (HxWxD)	mm	1,670x750x510	1,670x950x510	1,670x1,170x510	1,900x1,170x720	1,900x1,470x720	
Machine weight	kg	118	144	169	236	281	
Sound level *1	dB(A)	52	56	60	65	62	
Air filter	Type	Long-life filter (anti-mould resin net)					
Fan	Motor output	0.75		1.5		3.7	
	Airflow rate	m <sup>3</sup> /min	43	69	86	134	165
		cfm	1,518	2,436	3,036	4,730	5,825
	External static pressure *2	Pa	152	217	281	420	142

Note: Specifications are based on the following conditions:  
 • Cooling: Indoor temp.: 27°CDB, 19°CWB, Outdoor temp.: 35°CDB, Equivalent piping length: 7.5 m, Level difference: 0 m.  
 • Capacity of indoor unit is only for reference. Actual capacity of indoor unit is based on the total capacity index. (See Engineering Data Book for details.)  
 \*1: Sound level : measured when the air discharge outlet duct (2 m) is attached (anechoic chamber conversion value). It increases by approximately 5 dB(A) when the plenum chamber is installed to deliver direct airflow.  
 \*2: The value is the external static pressure with standard pulley.

### Concealed Floor Standing Type

FXNQ-MA

Designed to be concealed in the perimeter skirting-wall



### Specifications

MODEL		FXNQ20MAVE4	FXNQ25MAVE4	FXNQ32MAVE4	FXNQ40MAVE4	FXNQ50MAVE4	FXNQ63MAVE4
Power supply		1-phase, 220-240 V/220 V, 50/60 Hz					
Cooling capacity	Btu/h	7,500	9,600	12,300	15,400	19,100	24,200
Power consumption	kW	0.049	0.049	0.090	0.090	0.110	0.110
Airflow rate (H/L)	m <sup>3</sup> /min	7/6	7/6	8/6	11/8.5	14/11	16/12
	cfm	247/212	247/212	282/212	388/300	494/388	565/424
Sound level (H/L)	220 V	35/32	35/32	35/32	38/33	39/34	40/35
	240 V	37/34	37/34	37/34	40/35	41/36	42/37
Dimensions (HxWxD)	mm	610x930x220	610x930x220	610x1,070x220	610x1,070x220	610x1,350x220	610x1,350x220
Machine weight	kg	19.0	19.0	23.0	23.0	27.0	27.0

Note: Specifications are based on the following conditions;

- Cooling: Indoor temp.: 27°CDB, 19°CWB, Outdoor temp.: 35°CDB, Equivalent piping length: 7.5 m, Level difference: 0 m.
- Capacity of indoor unit is only for reference. Actual capacity of indoor unit is based on the total capacity index. (See Engineering Data Book for details.)
- Sound level: Anechoic chamber conversion value, measured at a point 1.5 m in front of the unit at a height of 1.5 m. During actual operation, these values are normally somewhat higher as a result of ambient conditions.

### Clean Room Air Conditioner

FXB(P)Q-P

Suitable for hospitals and other clean spaces



### Specifications

Type		Integrated outlet unit model			Separate outlet unit model
MODEL	Indoor unit	FXBQ40PVE	FXBQ50PVE	FXBQ63PVE	FXBPQ63PVE
	Outlet unit	Integrated with the indoor unit			BAF82A63
Power supply		1-phase, 220-240 V/220 V, 50/60 Hz			
Cooling capacity	Btu/h	15,400	19,100	24,200	24,200
Power consumption	kW	0.31	0.31	0.45	0.45
Intake filter efficiency *1		70% by gravimetric method			
Outlet HEPA filter efficiency *2		99.97% by DOP method *5			
Indoor unit weight	kg	140 *3		185 *3	120 *6
Casing		Galvanised steel plate			
Airflow rate (H/L)	m <sup>3</sup> /min	19.5/17.5		26/22.5	
	cfm	688/618		918/794	
Sound level (H/L) *4	dB(A)	44/42			
Dimensions (HxWxD)	mm	492x1,788x1,000		492x1,788x1,300	492x1,078x1,300
Outlet unit weight	kg	-			65 *3

Note: Specifications are based on the following conditions;

- Cooling: Indoor temp.: 27°CDB, 19°CWB, Outdoor temp.: 35°CDB, Equivalent piping length: 7.5 m, Level difference: 0 m.
- Capacity of indoor unit is only for reference. Actual capacity of indoor unit is based on the total capacity index. (See Engineering Data Book for details.)
- \*1: An intake air filter is only attached to the ceiling intake type.
- \*2: HEPA filter sold separately. The dust collection efficiency of HEPA filter is 99.97%. However, air may slightly leak around the filter when installing.
- \*3: Weight including HEPA filter and panel.
- \*4: Anechoic chamber conversion value under JIS B 8616 test conditions. Value usually increases slightly in practice due to surrounding conditions.
- \*5: The clean room air conditioner does not support DOP testing (leak test) based on GMP standards (Standards for Manufacturing Control and Quality Control for Medical Devices) due to slight leakage at time of product installation.
- \*6: Weight including panel.

\*In the case of an installation in an operating theatre etc. where an air conditioner malfunction may have serious consequences, please build in redundancy with two or more outdoor units.

### Slim Ceiling Mounted Duct Type

FDKS-EA/C

Slim and smooth design suits your shallow ceiling

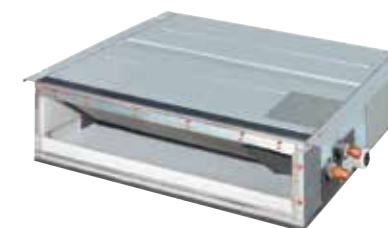

Standard accessory  
Note: Remote controllers other than the standard accessory wireless remote controller cannot be used.

### Specifications

MODEL		FDKS25EAVMB	FDKS35EAVMB	FDKS25CAVMB	FDKS35CAVMB	FDKS50CVMB	FDKS60CVMB
Power supply		1-phase, 220-240 V/220-230 V, 50/60 Hz					
Airflow rates (H)	m <sup>3</sup> /min (cfm)	8.7 (307)		9.5 (335)	10.0 (353)	12.0 (424)	16.0 (565)
Sound levels (H/L/SL)*	dB (A)	35/31/29			37/33/31	38/34/32	
Fan speed		5 steps, quiet and automatic					
Temperature control		Microcomputer control					
Dimensions (HxWxD)	mm	200x700x620		200x900x620		200x1,100x620	
Machine weight	kg	21		25	27	30	
External static pressure	Pa	30		40			

Note: \* The operation sound level values represent those for rear-suction operation and an external static pressure of 30 Pa for FDKS-EA and 40 Pa for FDKS-C. Sound level values for bottom-suction operation can be obtained by adding 6 dB (A) for FDKS-EA and 5 dB (A) for FDKS-C.

### Wall Mounted Type

FTKJ-N

Elegant appearance with European style



Standard accessory



### Specifications

MODEL		FTKJ25NVMW	FTKJ25NVMS	FTKJ35NVMW	FTKJ35NVMS	FTKJ50NVMW	FTKJ50NVMS
Power supply		1-phase, 220-240 V/220-230 V, 50/60 Hz					
Front panel colour		White	Silver	White	Silver	White	Silver
Airflow rates (H)	m <sup>3</sup> /min (cfm)	8.9 (313)		10.9 (385)			
Sound levels (H/L/SL)	dB (A)	38/25/19		45/26/20		46/35/29	
Fan speed		5 steps, quiet and automatic					
Dimensions (HxWxD)	mm	303x998x212					
Machine weight	kg	12					

Wall Mounted Type

FTKS-D/B/F

Stylish flat panel harmonises with your interior décor



\* Remote controllers other than the standard accessory wireless remote controller cannot be used.

Specifications

MODEL	FTKS25DVM	FTKS35DVM	FTKS60FVM	FTKS71FVM	
Power supply	1-phase, 220-240 V/220-230 V, 50/60 Hz				
Front panel colour	White				
Airflow rates (H)	m <sup>3</sup> /min (cfm)	8.7 (307)	8.9 (314)	16.2 (572)	17.4 (614)
Sound levels (H/L/SL)	dB (A)	37/25/22	39/26/23	45/36/33	46/37/34
Fan speed	5 steps, quiet and automatic				
Dimensions (HXWXD)	mm	283x800x195		290x1,050x238	
Machine weight	kg	9		12	

BP Units for Connection to Residential Indoor Units

Specifications



BPMKS967A3



BPMKS967A2

MODEL	BPMKS967A3	BPMKS967A2		
Power supply	1-phase, 220-240 V/220-230 V, 50/60 Hz			
Number of ports	3 (connectable to 1-3 indoor units)	2 (connectable to 1-2 indoor units)		
Power consumption	W	10		
Running current	A	0.05		
Dimensions (HXWXD)	180X294 (+356*)X350			
Machine weight	kg	8 / 7.5		
Number of wiring connections	3 for power supply (including earth wiring), 2 for interunit wiring (outdoor unit-BP, BP-BP), 4 for interunit wiring (BP-indoor unit)	2 for power supply (including earth wiring), 2 for interunit wiring (outdoor unit-BP, BP-BP), 3 for interunit wiring (BP-indoor unit)		
Piping connections (Brazing)	Liquid	Main	mm	Ø9.5X1
		Branch	mm	Ø6.4X3 / Ø6.4X2
	Gas	Main	mm	Ø19.1X1
		Branch	mm	Ø15.9X3 / Ø15.9X2
Heat insulation	Both liquid and gas pipes			
Connectable indoor units	2.0 kW class to 7.1 kW class			
Min. rated capacity of connectable indoor units	kW	2.0		
Max. rated capacity of connectable indoor units	kW	20.8 / 14.2		

Note: \* Total auxiliary piping length.

PM2.5 filtration unit

Double-layered efficient filtration

PM2.5 filters are double-layered.

1. The front filter effectively removes large particles.
2. The PM2.5 filter layer contains a large amount of static electricity to capture particulate matter efficiently.

Optional :  
Active Carbon Filtration Unit

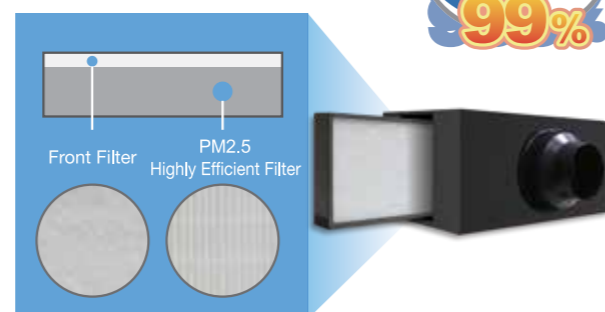

Air Handling Unit

Integrate your air handling unit in a total solution for large size spaces such as factories and large stores.

- Easy design and installation  
The system is easy to design and install since no additional water systems such as boilers, tanks and gas connections etc are required.
- Inverter controlled units
- Control of air temperature via standard Daikin wired remote control for standard series



AHUR  
Capacity range : 6 – 120 HP

System overview

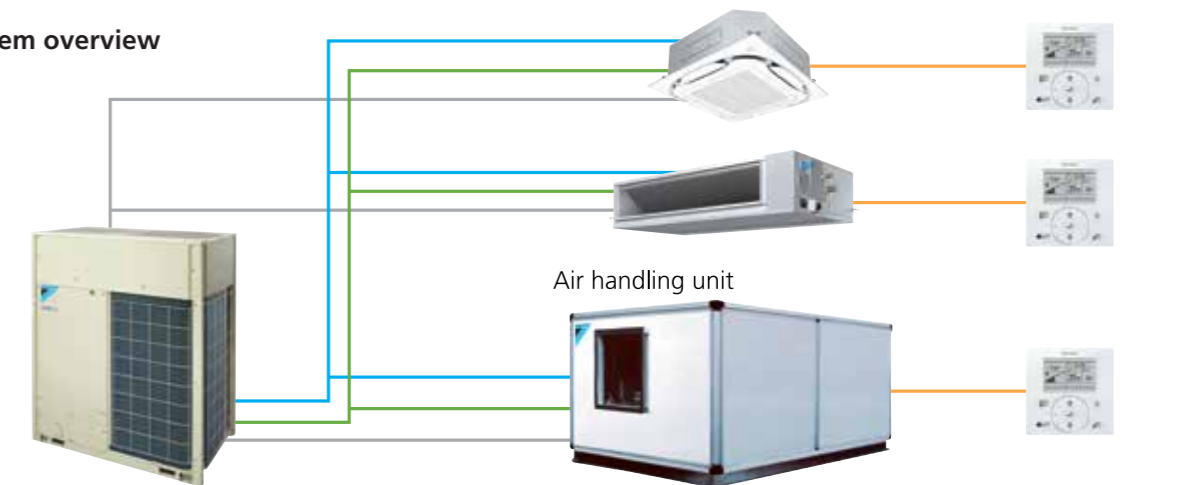

Daikin air handling units can be connected to VRF systems. This combination can be built to order as a system. Outdoor air series is also possible. Please contact your local sales office for details.



# Air Treatment Equipment

Daikin's air treatment systems creating a higher IAQ

Components of indoor air quality

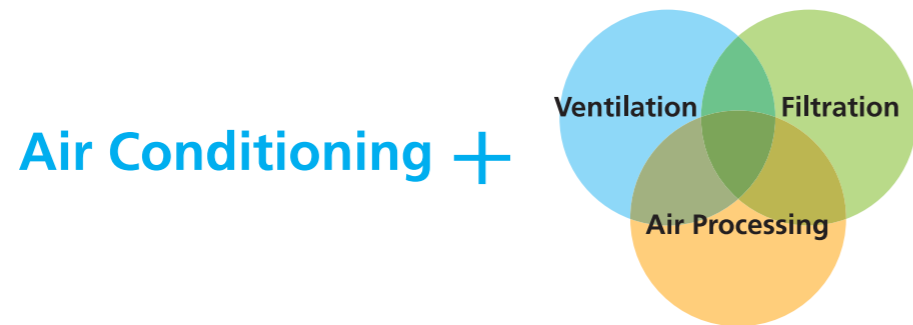

A recent trend rapidly gaining popularity is for air treatment to be required as well as air conditioning. Daikin has a lineup of 3 products that provide adequate IAQ, according to the client's needs.

## Our Solutions for Indoor Air Quality Problems

You may think cool and comfortable air-conditioned room is enough, but...

**1** If the windows are closed in an air-conditioned room

Virus and CO<sub>2</sub> will accumulate in the room.

**2** But if you open the windows...

PM2.5 and humidity will come in, and it will become hot.

**3** Let's close the windows and turn on the air purifier!

Air conditioning regulates heat and humidity, and air purifier can remove PM2.5, but CO<sub>2</sub> remains high. It is hard to concentrate.

**4** If you have mechanical ventilation system such as Heat Reclaim Ventilator...

Finally, the CO<sub>2</sub> has been removed, and a comfortable space has been achieved!

Ventilation equipment can be selected according to suit purpose and circumstances

	Outdoor Air Processing Unit		Heat Reclaim Ventilator	
	FXMQ-MF series	FXMQ-BF series	VKM-GC series	VAM-H series
Connections with VRV systems	Refrigerant Piping	Connectable	Connectable	Not connectable
	Wiring	Connectable	Connectable	Connectable
	After-cool & After-heat Control	Available	Available	Not available
Ventilation class		Class 2	Class 1	Class 1
		Air supply only	Air supply only	Air supply & air exhaust
Heat Exchange Element	—	—	Energy savings obtained	Energy savings obtained
High Efficiency Filter (Option)	Available	—	Available	Available
PM2.5 Filter (Option)	—	—	Available	Available
MERV8/14 Filter (Option)	—	Available	—	—
Airflow Rate	1,080 - 2,100 m <sup>3</sup> /h	690 - 2,160 m <sup>3</sup> /h	500 - 950 m <sup>3</sup> /h	150 - 2,000 m <sup>3</sup> /h

\*1. Optional filter is necessary. Refer to option list for details.  
\*2. Refers to bringing outdoor air to near indoor temperature and delivering to a room.

## Ventilation class

Class 1 Ventilation	Class 2 Ventilation	Class 3 Ventilation
Installing a Heat Reclaim Ventilator enables mechanical ventilation to control both air supply and air exhaust while ensuring continuous room comfort through the supply of temperature-controlled air.	Mechanical ventilation is used for air supply, and natural ventilation is used for air exhaust. This prevents dirty outdoor air from entering and maintains a clean environment even for large spaces.	Natural ventilation is used for air supply, and mechanical ventilation is used for air exhaust. Odours and steam generated indoors are eliminated before spreading to other areas.

# Air Treatment Equipment

## Outdoor-Air Processing Unit (Discharge Air Temperature Control Type)

### FXMQ-MF Series

Combine fresh air treatment and air conditioning, supplied from a single system.



Fresh air treatment and air conditioning can be achieved with a single system. VRV indoor units for air conditioning and an outdoor-air processing unit can be connected to the same refrigerant line.

#### Lineup

Model Name	FXMQ125MFV7	FXMQ200MFV7	FXMQ250MFV7
Capacity index	125	200	250
Airflow rate	1,080 m <sup>3</sup> /h	1,680 m <sup>3</sup> /h	2,100 m <sup>3</sup> /h

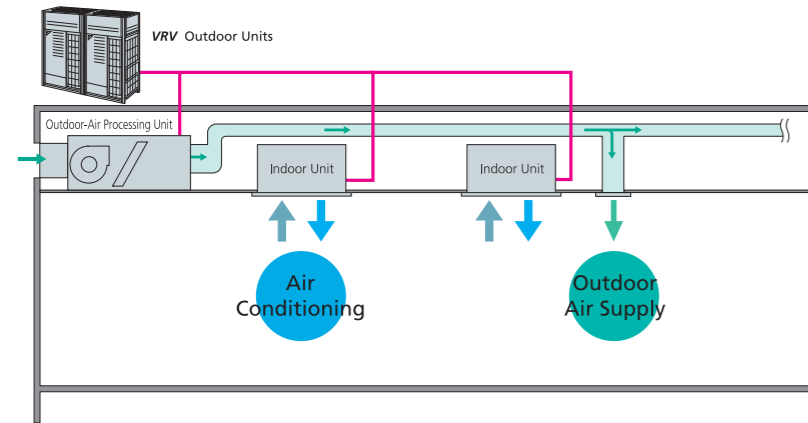

#### Connection Conditions

- Outdoor-air processing units can be used without indoor units. The total connection capacity index must be 50% to 100% of the capacity index of the outdoor units.
- When outdoor-air processing units and standard indoor units are combined, the total connection capacity index of the outdoor-air processing units must not exceed 30% of the capacity index of the outdoor units. Because connection is possible depending on conditions even when the capacity index of outdoor-air processing units exceeds 30% of the capacity index of the outdoor units, contact your local distributor.

### Outdoor-air processing / Discharge air temperature control

The unit supplies outdoor fresh air controlling discharge air temperature from the unit.

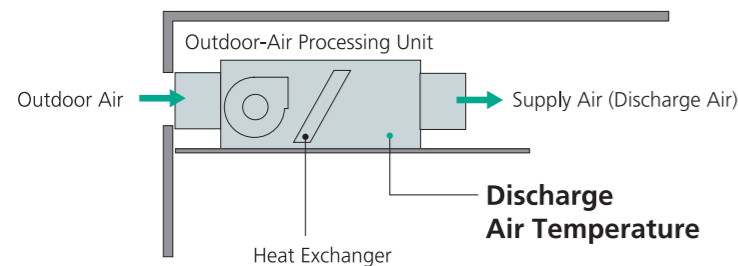

- \* The default setting of the discharge air temperature is 18°C for cooling operation, and 25°C for heating operation.
- \* While in unit protection mode and depending on outdoor air conditions, discharge air temperature may not be at the set temperature.
- \* The fan stops in defrosting, oil returning and hot start operations due to mechanical protection control.

### Operation range

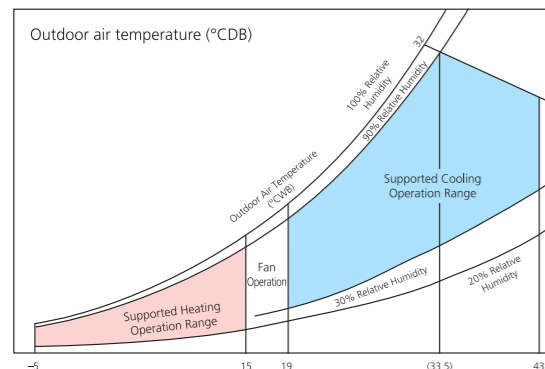

Applicable to outdoor air temperature range from -5 to 43°C. In cooling operation, 19 to 43°C is adoptable.

- Notes:
1. The operation range shown in the graph is under the following conditions. Equivalent piping length: 7.5 m, Height difference: 0 m.
  2. The system will not operate in fan mode when the outdoor air temperature is 5°C or below.

#### Precautions for use of FXMQ-MF series

1. This unit is intended for the treatment of outdoor air only. Not to be used for maintaining indoor air temperature. Be sure that the discharge airflow will not blow on people directly.
2. Group control of the product and standard indoor units is not supported. A separate remote controller should be connected to individual unit.
3. If the unit is utilised to operate 24 hours a day, maintenance (part replacement, etc.) must be performed periodically.
4. Temperature setting and Power Proportional Distribution (PPD) are not possible even if the intelligent Touch Controller or the intelligent Touch Manager is installed.
5. The remote controller wired to the outdoor-air processing unit must not be set as the master remote controller. Otherwise, when set to "Auto," the operation mode will switch according to the outdoor air conditions, regardless of the indoor temperature.

### Specifications

Type		Ceiling Mounted Duct Type			
MODEL		FXMQ125MFV7	FXMQ200MFV7	FXMQ250MFV7	
Power supply		1-phase 220-240 V, 50 Hz			
Cooling capacity *1	Btu/h	47,800	76,400	95,500	
	kW	14.0	22.4	28.0	
Power consumption		kW	0.359	0.548	0.638
Casing		Galvanised steel plate			
Dimensions (H × W × D)		mm	470 × 744 × 1,100	470 × 1,380 × 1,100	
Fan	Motor output	kW	0.380		
	Airflow rate	m <sup>3</sup> /min	18	28	35
		cfm	635	988	1,236
External static pressure	220 V/240 V	Pa	185/225	225/275	205/255
Air filter		*2			
Refrigerant piping	Liquid	mm	φ 9.5 (Flare)		
	Gas	mm	φ 15.9 (Flare)	φ 19.1 (Brazing)	φ 22.2 (Brazing)
	Drain	mm	PS1B female thread		
Machine weight		kg	86	123	123
Sound level *3		220 V/240 V	dB(A)	42/43	47/48
Connectable outdoor units *4			6 HP and above	8 HP and above	10 HP and above
Operation range (Fan mode operation between 15 and 19°C)			19 to 43°C		
Range of the discharge temperature *5			13 to 25°C		

- Notes:
- \*1. Specifications are based on the following conditions:
    - Cooling: Outdoor temp. of 33°CDB, 28°CWB (68% RH), and discharge temp. of 18°CDB.
    - Equivalent reference piping length: 7.5 m (0 m horizontal)
  - \*2. An intake filter is not supplied, so be sure to install the optional long-life filter or high-efficiency filter.
  - \*3. Anechoic chamber conversion value, measured at a point 1.5 m downward from the unit centre. These values are normally somewhat higher during actual operation as a result of ambient conditions.
  - \*4. It is possible to connect to the outdoor unit if the total capacity of the indoor units is 50% to 100% of the capacity index of the outdoor unit.
  - \*5. Local setting mode is not displayed on the remote controller.
    - This equipment cannot be incorporated into the remote group control of the VRV system.

### Options

MODEL		FXMQ125MFV7	FXMQ200MFV7	FXMQ250MFV7	
Operation/control	Operation remote controller	BRC1H63W(K) / BRC1E63 / BRC2E61			
	Central remote controller	DCS302CA61			
	Unified ON/OFF controller	DCS301BA61			
	Schedule timer	DST301BA61			
	Wiring adaptor for electrical appendices (2)	KRP4AA51			
Filters	Long-life replacement filter	KAF371N140	KAF371N280		
	High-efficiency filter	Colourimetric method 65%	KAF372M140	KAF372M280	
		Colourimetric method 90%	KAF373M140	KAF373M280	
	Filter chamber *	KDJ3705L140	KDJ3705L280		
Streamer duct chamber		BDEZ500A140VE	BDEZ500A510VE		
Drain pump kit		KDU30L250VE			
Adaptor for wiring		KRP1B61			

- Notes:
- \* Filter chamber has a suction-type flange. (Main unit does not.)
  - Dimensions and weight of the equipment may vary depending on the options used.
  - Some options may not be usable due to the equipment installation conditions, so please confirm prior to ordering.
  - Some options may not be used in combination.
  - Operating sound may increase somewhat depending on the options used.

# Air Treatment Equipment

## Outdoor-Air Processing Unit (Room Temperature Control Type)

### New FXMQ-BF Series

Improve IAQ with fresh air ventilation and precise room temperature control



Fresh air treatment and air conditioning can be achieved with a single system. **VRV** indoor units for air conditioning and an outdoor-air processing unit can be connected to the same refrigerant line.

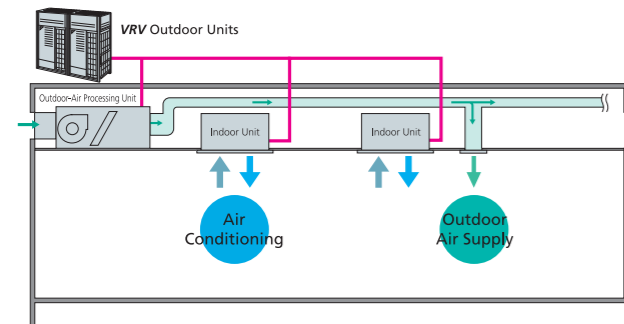

#### Lineup

Model Name	FXMQ80BFV24	FXMQ140BFV24	FXMQ200BFV24	FXMQ250BFV24
Capacity index	80	140	200	250
Airflow rate	690 m³/h	1,230 m³/h	1,740 m³/h	2,160 m³/h

Type of connected indoor units	Connction ratio	FXMQ-BF connection ratio
FXMQ-BF only		50%-130%
Mixed combination (FXMQ-BF and standard VRV indoor units)	120%-130%	≤10%
	110%-120%	≤20%
	100%-110%	≤30%
	50%-100%	≤40%

$$\text{Connection ratio} = \frac{\text{Total capacity index of the indoor units}}{\text{Capacity index of the outdoor units}}$$

#### Larger connection ratio

Maximum connection ratio increased from 100% to 130%.  
When outdoor-air processing units and standard **VRV** indoor units are combined, the total connection capacity index of the outdoor-air processing units must not exceed 40% of the capacity index of the outdoor units.

### Outdoor-air processing / Room temperature control

The unit improves IAQ with fresh air ventilation and precise room temperature control.

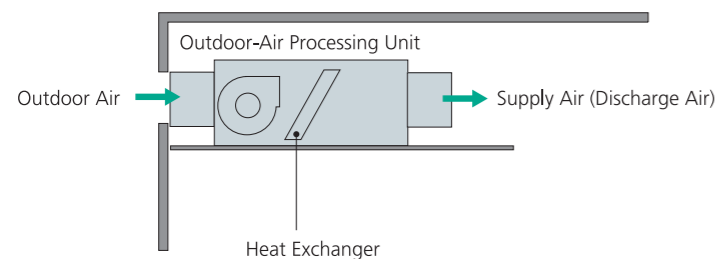

Set point temperature can be selected similar to standard **VRV** indoor unit. Maintains comfortability and precise temperature control in large areas with the remote sensor option BRC501A-6.

- \* This unit cannot be used to handle internal heat loads.
- \* The discharge air temperature changes depending on the air conditioning load, outside air temperature, and operation of the protective device.  
When the protection function is activated, unprocessed outside air maybe sent directly.
- \* The fan stops in defrosting, oil returning and hot start operations due to mechanical protection control.

#### 3-step airflow control

Control of the airflow rate has been improved from 1-step to 3-step control, which enhance usage and design flexibility.

#### Slim & compact design

Only 300 mm in height and 700 mm in depth, the new casing comes with smaller footprint and with 59% reduction\* in unit size.

\* Reduction in size compared to conventional FXMQ200/250MF series

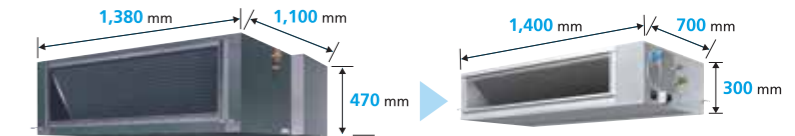

#### Lower power consumption

The change from AC motor to DC motor resulted in lower power consumption and more energy efficiency.

The new FXMQ200BF requires 79% less power consumption making it the perfect choice for small commercial applications.

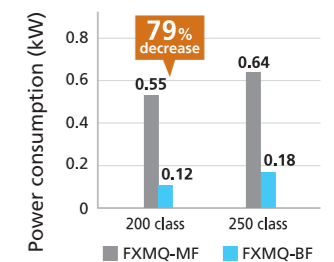

#### VRT control

With the VRT\* control feature, higher efficiency can be achieved.

\* Default setting is VRT off and field setting is required.



#### New small capacity model

The new 9 kW capacity model is the perfect fit for smaller business such as small/medium-sized shops and convenience stores.

#### Adjustable external static pressure

Using a DC fan motor, the external static pressure can be controlled within a range of 50 Pa to 200 Pa.

#### Adjustable external static pressure

50 Pa to 200 Pa

#### "Airflow rate auto adjustment function" at field setting (local setting by remote controller)

\*This function can only be set via wired remote controller.

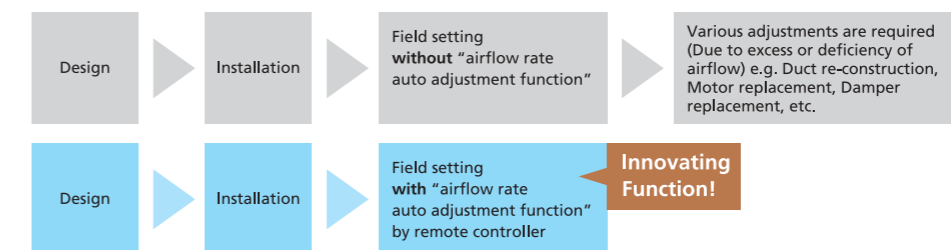

<Mechanism>

1. During field setting, power input of DC fan is detected.
2. External static pressure is estimated from power input of DC fan because PCB of FXMQ-BF has table of external static pressure vs. power input of DC fan.
3. Actual duct resistance is calculated according to 1 and 2.
4. Fan speed is automatically adjusted to produce rated airflow.

Notes: "Airflow rate auto adjustment function" can be adjusted within ±10% of rated airflow. (Refer to Engineering Data Book for details)  
"Airflow rate auto adjustment function" should be used at field setting only.

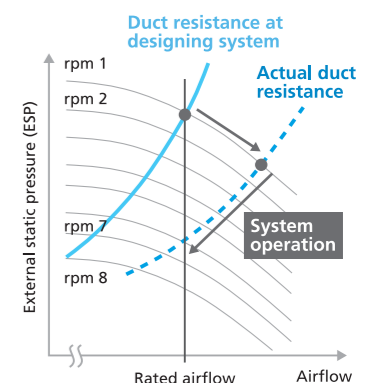



# Air Treatment Equipment

## Outdoor-Air Processing Unit (Room Temperature Control Type)

### Extended operation range

The outdoor operation temperature range extended from 19 to 15°CDB\*. This enables reliable operation even under wider temperature conditions.

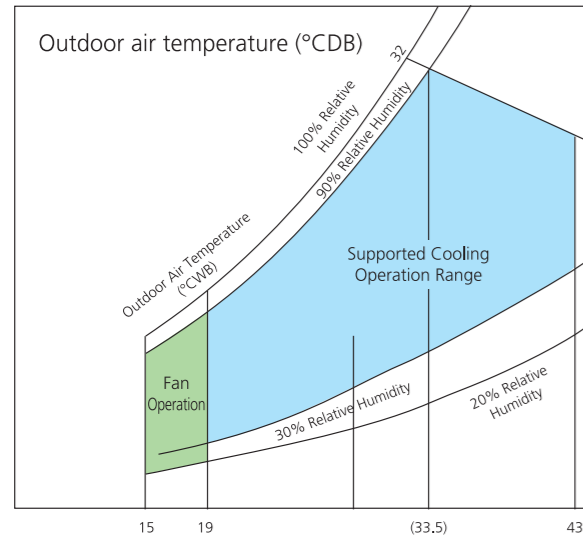

Extended operation range:  
Cooling: 15°CDB to 43°CDB

\* Thermo-off (fan) operation starts automatically when cooling 19°CDB or less. Operation range can be extended to 15°CDB by field setting.

### High efficiency filter (MERV8/MERV14) (Option)

The filter options of MERV8 and MERV14 are available. The high efficiency filter can help remove infectious aerosol in the air.



MERV8 filter



MERV14 filter

## Specifications

Model		FXMQ80BFV24	FXMQ140BFV24	FXMQ200BFV24	FXMQ250BFV24	
Power supply		1 phase, 220 V, 50 Hz				
Cooling capacity *1	Btu/h	30,700	54,600	76,400	95,500	
	kW	9.0	16.0	22.4	28.0	
Power consumption		0.080	0.100	0.115	0.180	
Casing		Galvanised steel plate				
Dimensions (HxWxD)		mm	300x700x700	300x1,000x700	300x1,400x700	
Fan	Motor output	kW	0.140	0.350		
	Airflow rate (H/M/L)	m³/min	11.5/8.6/5.8	20.5/15.4/10.3	29.0/21.8/14.5	36.0/27.0/18.0
		cfm	406/304/205	724/544/364	1,024/770/512	1,271/953/635
	External static pressure	Pa	Rated 100 (200-50)			
Air filter		*2				
Refrigerant piping	Liquid	φ 9.5 (Flare)				
	Gas	φ 15.9 (Flare)		φ 19.1 (Brazing)	φ 22.2 (Brazing)	
	Drain	VP25 (External dia. 32, Internal dia. 25)				
Machine weight		kg	29	37	47	48
Sound level (H/M/L) *3		dB(A)	37.5/30/23	41/34/25	42/35/26	44/36/27
Operation range *4		°CDB	15 to 43			

Notes:

- \*1. The capacity is the maximum value under the following conditions:
  - Cooling: Indoor temp. of 33°CDB, 28°CWB, Outdoor temp. of 33°CDB.
  - Equivalent reference piping length: 7.5 m (0 m horizontal)
  - The rated external static pressure and air volume are set in ( ).
- \*2. An intake filter is not supplied, so be sure to install the optional filter.
- \*3. Anechoic chamber conversion value, measured at a point 1.5 m downward from the unit centre. These values are normally somewhat higher during actual operation as a result of ambient conditions.
- \*4. The operation range can be extended to 15°C by field setting. When fresh air intake mode is enabled, operation range cannot be extended. (limit at 19 to 43°C)

## Options

Model		FXMQ80BFV24	FXMQ140BFV24	FXMQ200BFV24	FXMQ250BFV24
Operation/Control	Wired remote controller	BRC1H63W(K) / BRC1E63 / BRC2E61			
	Wireless remote controller	BRC4C66			
	Remote sensor (for indoor temperature)	BRC501A-6			
	Central remote controller	DCS302CA61			
	Unified ON/OFF controller	DCS301BA61			
	Schedule timer	DST301BA61			
	Filters	MERV8 filter	BAF376B56	BAF376B80	BAF376B160
MERV14 filter		BAF377B56	BAF377B80	BAF377B160	
Filter chamber for MERV8/14 filter		KDDF37AB56	KDDF37AB80	KDDF37AB160	
Long life replacement filter		KAF371B56	KAF371B80	KAF371B160	
Streamer duct chamber		BDEZ500A140VE	BDEZ500A140VE BDEZ500A510VE	BDEZ500A510VE	
Service panel		KTBJ25K56F	KTBJ25K80F	KTBJ25K160F	
Air discharge adaptor		KDAJ25K56A	KDAJ25K71A	KDAJ25K140A	
Adaptor for wiring (operation status output)		★ BRP11B62			
Wiring adaptor for electrical appendices (1)		★ KRP2A61			
Wiring adaptor for electrical appendices (2)		★ KRP4AA51			
Installation box for adaptor PCB ☆ *1		★ KRP4A96 *2,3			
External control adaptor for outdoor unit		★ DTA104A61			
Adaptor for multi tenant (24V type)		★ DTA114A61			
Multi tenant unit for indoor (24V free type)		★ BRP114A61			
Multi tenant unit Booster (24V free type)		★ BRP114A63			
Digital input adaptor for hotel application		★ BRP7A53			

Notes:

- \*1. Installation Box ☆ is necessary for each adaptor marked ★.
- \*2. Up to 2 adaptors can be fixed for each installation box.
- \*3. Only one installation box can be installed for each indoor unit.

# Air Treatment Equipment

## Heat Reclaim Ventilator with DX-coil

### VKM-GC Series

Air quality improvement by introducing fresh outdoor air in the room



#### Lineup

Model	VKM50GCVE	VKM80GCVE	VKM100GCVE
Capacity Index	31.25	50	62.5
Airflow rate	500 m³/h	750 m³/h	950 m³/h

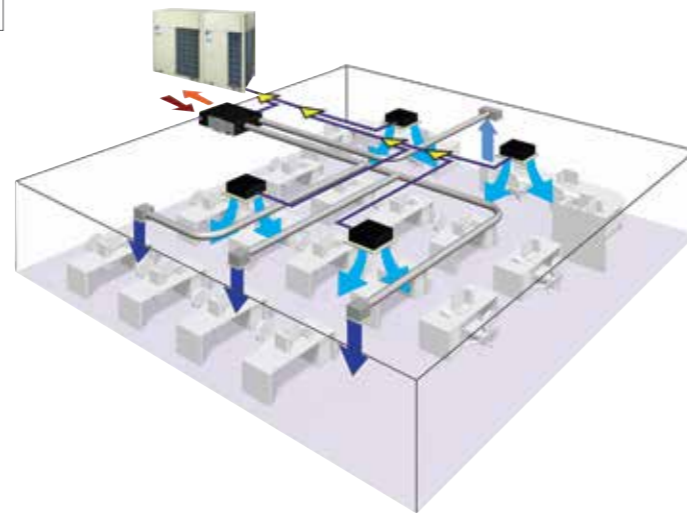

### ■ IAQ improvement by fresh air

Maintains comfortable indoor air quality (IAQ) by adding fresh outdoor air having nearly the same temperature and humidity conditions as the indoor air.

This energy-saving heat reclaim ventilator further reduces air conditioning load.

### ■ Heat reclaim ventilator + Heat exchanger → Comfortable air supply

Equipped with a heat reclaim ventilator and a heat exchanger, the new VKM series minimizes room temperature fluctuations.

The supply air is cooled from 29°C to 17.2°C with DX-coil.

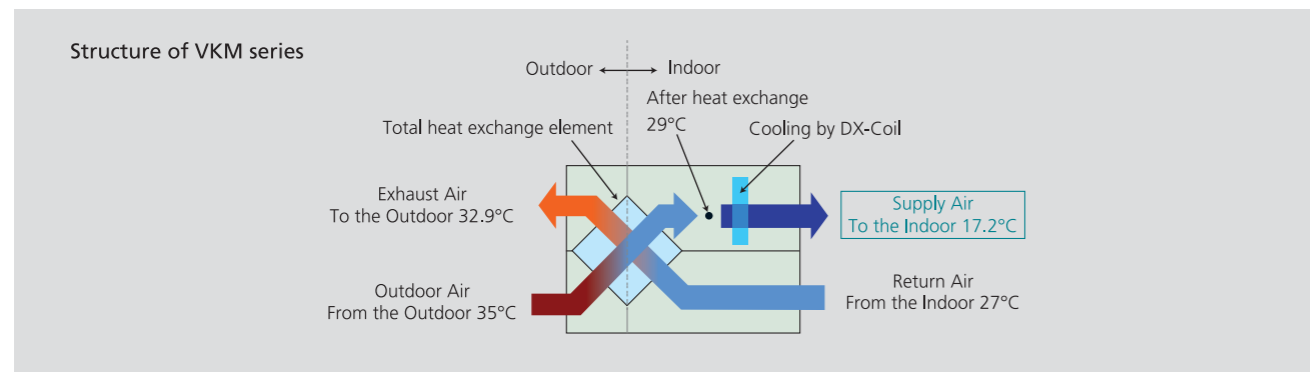

### ■ Equipped with DC fan motor

- Energy saving: Power consumption reduced by up to 51% (Class 50)
- Flexible installation due to high external static pressure: Increase of up to +50 Pa (Class 80)

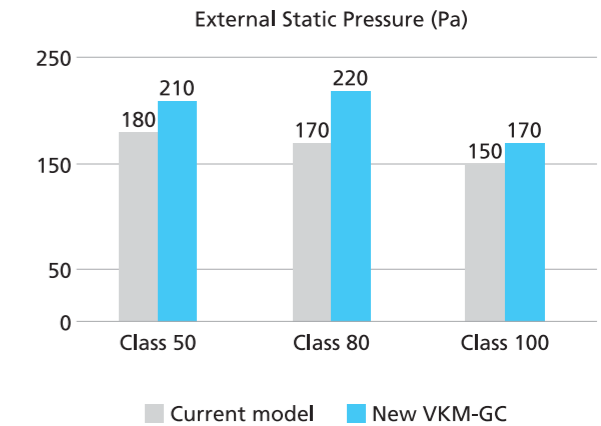
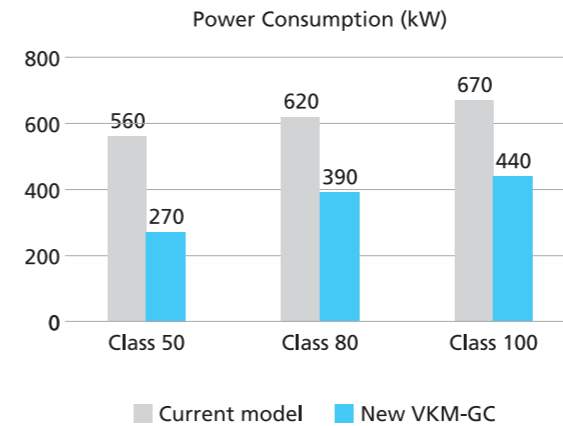

### ■ Supports both 50/60 Hz power supply

Current model 1-phase, 220-240 V, 50 Hz only

New model 1-phase, 220-240 V, 50 Hz  
1-phase, 220 V, 60 Hz

### ■ CO2 sensor control (Option) \* Refer to page 185 for details.

When CO2 sensor is installed, it detects the concentration of CO2 in the indoor air and the ventilation rate is controlled appropriately, reducing the air conditioning load due to ventilation.

### ■ PM2.5 filter (Option) \* Refer to page 186 - 188 for details.

Removes PM2.5 particulate matter present in the outdoor air, as well as sulfur oxides and nitrogen oxides, providing clean fresh air to the indoor ambient.

- PM2.5 filter: Removes 99% or more of 2.5 µm particulate matter.
- Activated Carbon filter: Removes sulfur oxides and nitrogen oxides

### ■ Other characteristics

- Nighttime free cooling operation \* Refer to page 182 for details.
- Stainless drain pan
- High-efficiency filter (Option)

# Air Treatment Equipment

A compact unit packed with Daikin's cutting-edge technologies.

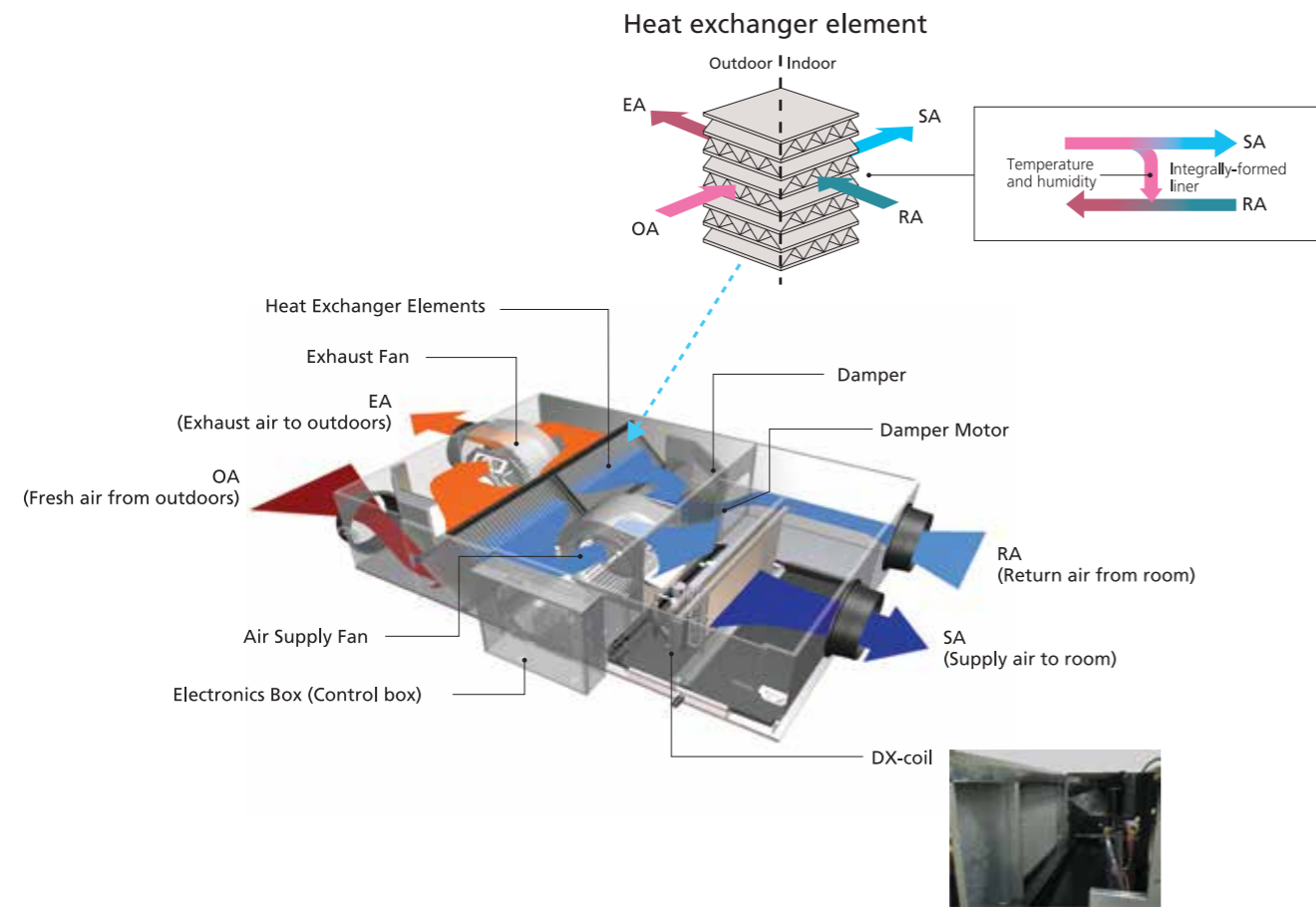

## Specifications

MODEL			VKM50GCVE	VKM80GCVE	VKM100GCVE
Refrigerant			R-410A		
Power Supply			1-phase, 220-240 V/220 V, 50/60 Hz		
Airflow Rate & External Static Pressure (Ultra-high / High / Low) (Note 4)	Airflow	m <sup>3</sup> /h	500/500/440	750/750/640	950/950/820
	Static pressure	Pa	210/170/140	220/180/125	170/120/90
Power Consumption (Ultra-high / High / Low)	Heat exchange mode	W	270/230/170	390/335/220	440/370/260
	Bypass mode	W	305/260/200	390/335/220	440/370/260
Fan Type			Sirocco Fan		
Motor Output			kW		
			0.21×2		
Sound Level (Note 3) (Ultra-high / High / Low)	Heat exchange mode	dB	43/40.5/39	41.5/39/37	41/39/36.5
	Bypass mode	dB	43/41/39	41.5/39/37	41/39/36.5
Temp. Exchange Efficiency (Ultra-high / High / Low)			%		
			76/76/77.5		
Enthalpy Exchange Efficiency (Ultra-high / High / Low)	Cooling	%	64/64/67	66/66/68	62/62/66
	Heating	%	67/67/69	71/71/73	65/65/69
Heat Exchanging System			Air to Air Cross Flow Total Heat (Sensible + Latent Heat) Exchange		
Heat Exchanger Element			Specially Processed Non flammable Paper		
Air Filter			Multidirectional Fibrous Fleeces		
DX-coil Capacity (Cooling / Heating) (Note 1) (Note 2)			kW		
			2.8 / 3.2		
Dimensions (Height×Width×Depth)			mm		
			387 × 1,764 × 832		
Piping Connection	Liquid	mm	φ 6.4 (Flare)		
	Gas	mm	φ 12.7 (Flare)		
	Drain		PT3/4 External Thread		
Machine Weight			kg		
			92		
Unit Ambient Condition	Around Unit		0°C–40°CDB, 80%RH or less		
	OA (Note 5)		-15°C–40°CDB, 80%RH or less		
	RA (Note 5)		0°C–40°CDB, 80%RH or less		

- Notes: 1. Indoor temperature: 27°CDB, 19°CWB, Outdoor temperature: 35°CDB  
 2. Indoor temperature: 20°CDB, Outdoor temperature: 7°CDB, 6°CWB  
 3. The operating sound measured at the point 1.5 m below the centre of the unit is converted to that measured in an anechoic chamber built in accordance with the JIS C 1502 conditions. The actual operating sound varies depending on the surrounding conditions (near running unit's sound, reflected sound and so on) and is normally higher than this value.  
 For operation in a quiet room, it is required to take measures to lower the sound.  
 For details, refer to the Engineering Data.  
 4. Airflow rate can be changed over to Low mode or High mode.  
 5. OA: fresh air from outdoor. RA: return air from room.  
 6. Temperature exchange efficiency is the mean value for Cooling and Heating. Efficiency is measured under the following condition: Ratio of rated external static pressure outdoor to indoor is kept constant at 7 to 1.

Air conditioning and outdoor air processing can be accomplished using a single system.

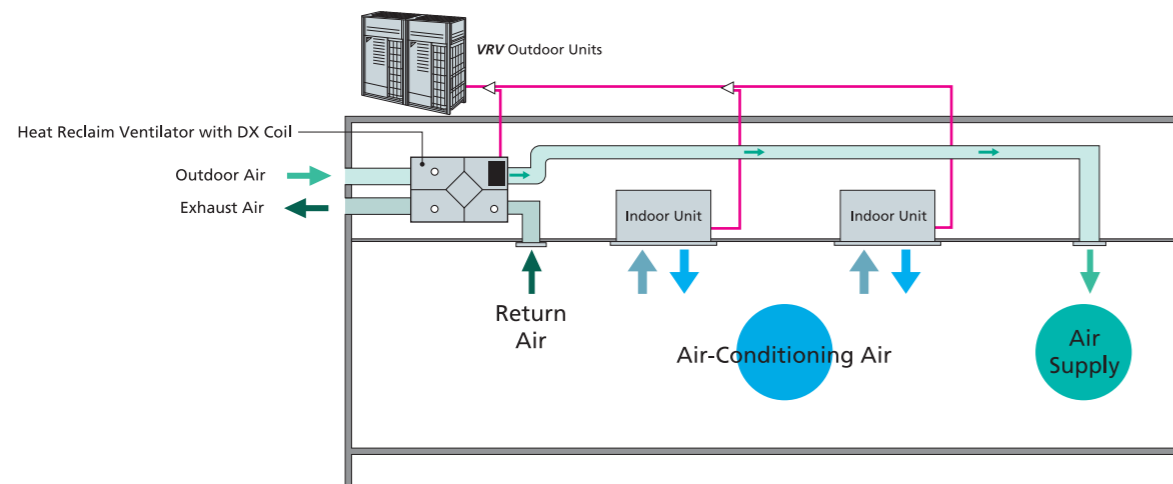

- When the VKM series units are connected, the total connection capacity index must be 50% to 130% of the capacity index of the outdoor units.

## Options

Item	Type	VKM50GCVE	VKM80GCVE	VKM100GCVE
Controlling device	Remote controller *1	BRC1H63W(K) / BRC1E63		
	PCB Adaptor	KRP2A61		
	Wiring adaptor for electrical appendices For heater control kit	BRP4A50A		
Additional function	Silencer	—	KDDM24B100	
	Nominal pipe diameter	mm	φ 250	
	High efficiency filter		KAF242J80M	KAF242J100M
Flexible duct	Air filter for replacement		KAF241G80M	KAF241G100M
		1 m	K-FDS201E	K-FDS251E
		2 m	K-FDS202D	K-FDS252E
CO <sub>2</sub> Sensor		BRYC24B50M	BRYC24B100M	
PM2.5 filtration unit *2		BAF249A500	BAF249A20A	
PM2.5 with activated carbon filtration unit *2		BAF249A500C	BAF249A20AC	
Streamer duct chamber		BDEZ500A60VE	BDEZ500A140VE	
		BDEZ500A140VE		

- \*1. Necessary when operating a Heat Reclaim Ventilator (VKM) independently. When operating interlocked with other air conditioners, use the remote controllers of the air conditioners.  
 \*2. Refer to pages 186 - 188 for details.  
 • Please inquire concerning optional accessories not listed above.

# Air Treatment Equipment

## Heat Reclaim Ventilator

### VAM-H Series

Daikin VAM series ensures fresh air intake and energy savings



Lineup		
VAM150HVE	VAM250HVE	VAM350HVE
VAM500HVE	VAM650HVE	VAM800HVE
VAM1000HVE	VAM1500HVE	VAM2000HVE

Airflow rate: 150-2,000 m<sup>3</sup>/h



BRC1H63W

BRC1H63K

### New features

#### Design flexibility

By significantly improving external static pressure, support for a variety of duct layouts is possible, and installation flexibility has been improved.

The 1000-2000 class model has become more compact, and ease of installation has improved.

#### Comparison of external static pressure

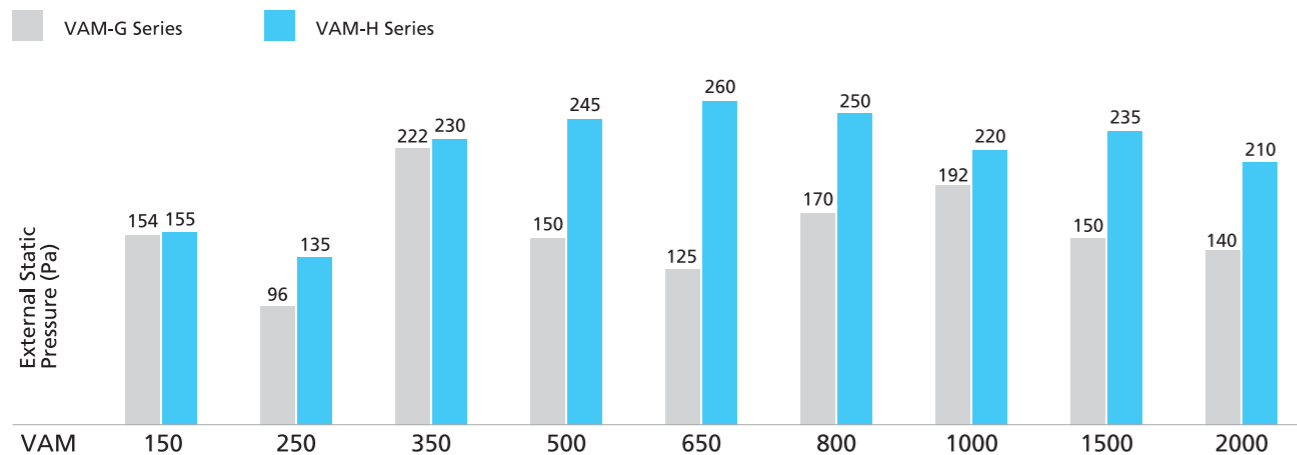

#### Improvement of installation workability

##### Improved workability by changing dimensions and shape of lifting lug

The structure that prevents nut slippage eliminates the need to replace the lifting lug even when installed upside down.

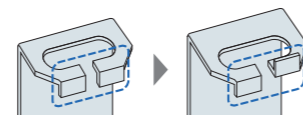

### Energy saving

#### Sensing sensor stop mode

In situation of no human occupancy is detected, the operation is turned off.

When the "Sensing sensor" installed on the air conditioner detects no occupancy in the room, the ventilation system and air conditioner system is turned off automatically to reduce energy wastage.

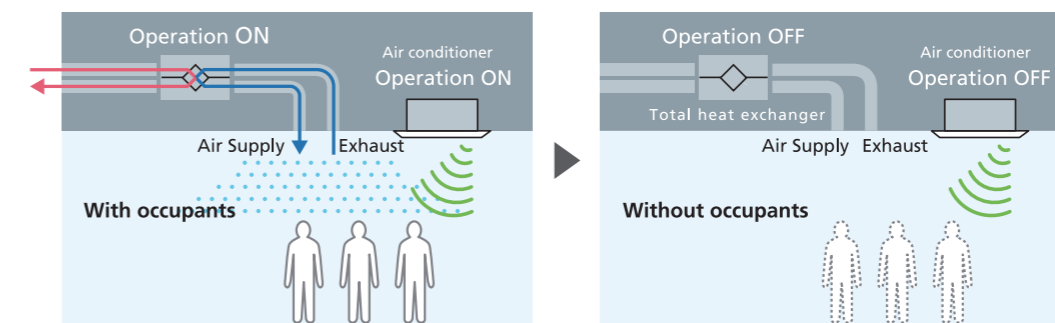

\* During group controlling of air conditioner, no occupancy stop mode cannot be used.

\* During 24-hours ventilation mode is turned on, the normal operation mode is changed to 24-hours ventilation mode.

\* Once the absence is detected and stopped, the operation will not be performed automatically again.

#### Humidity sensor (Option)

A humidity sensor (option) can be installed for greater comfort and energy-saving ventilation.

Conditions of low temperature and high humidity... Example, a rainy day, etc.

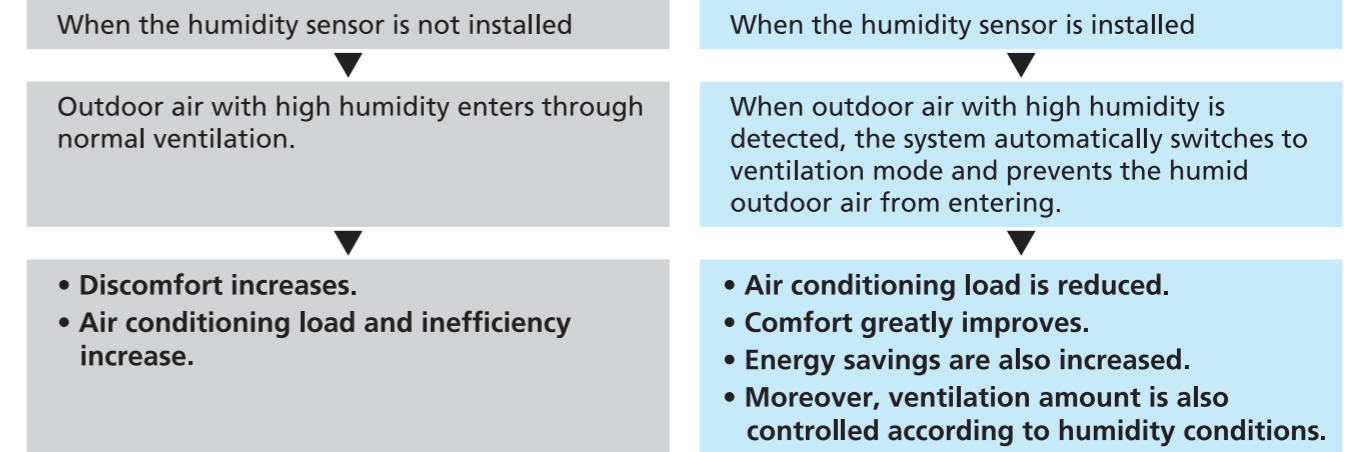

#### Stylish remote controller

NEW Stylish Remote Controller BRC1H63W (K) combining many VAM-dedicated functions

- Sensor results can be displayed up to 3 item on the information screen.
- Sensor results can be shared to the remote controller group.
- New icons such as 24-Hour Ventilating, Fresh Up, Nighttime Free Cooling Operation (Night Purge) have been added to the Information screen.

Sensor view of the Information screen

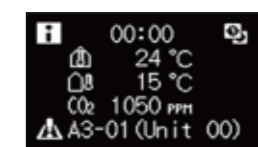

Note:  
3 items selected by remote controller setting.

# Air Treatment Equipment

## Heat Reclaim Ventilator

### Energy saving / Heat recovery functions

Air conditioner and ventilation system can be interlocked to provide even greater comfort and energy saving.

The system can be interlocked with Daikin air conditioners to provide energy saving ventilation solution for various situation.



### Pre-cool, Pre-heat control

#### Intentional delay of the start-up time

When the air conditioner is started up, the ventilation start-up is delayed to reduce load caused by the outside air. This reduces power consumption of air conditioners.

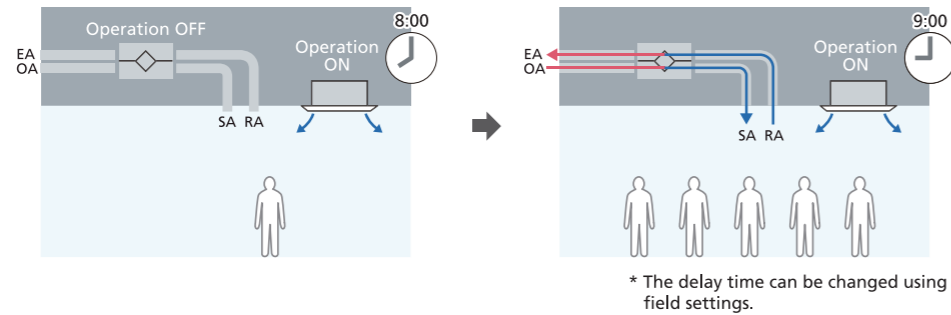

### Auto-ventilation mode changeover switching

#### Automatically determine the appropriate ventilation for each situation

Indoor temperature and the outdoor temperature are detected, and the system automatically switches to the ventilation mode which has higher energy-saving effect.

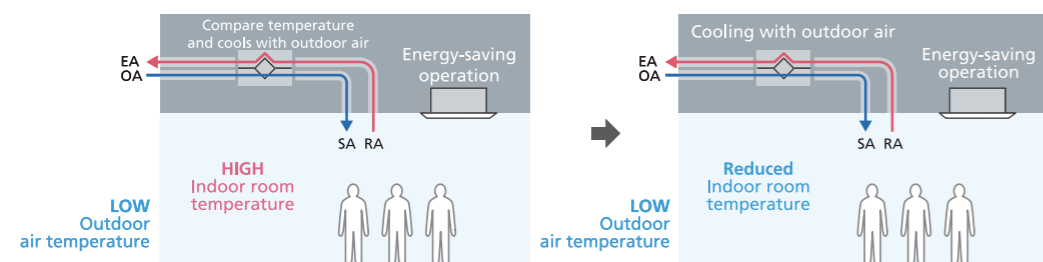

### Nighttime free cooling operation

#### Efficient use of outdoor air at night.

Rise in indoor temperature is avoided by automatically cooling the outdoor air at night, thus reducing air conditioning load at the start of cooling operation on the next morning.

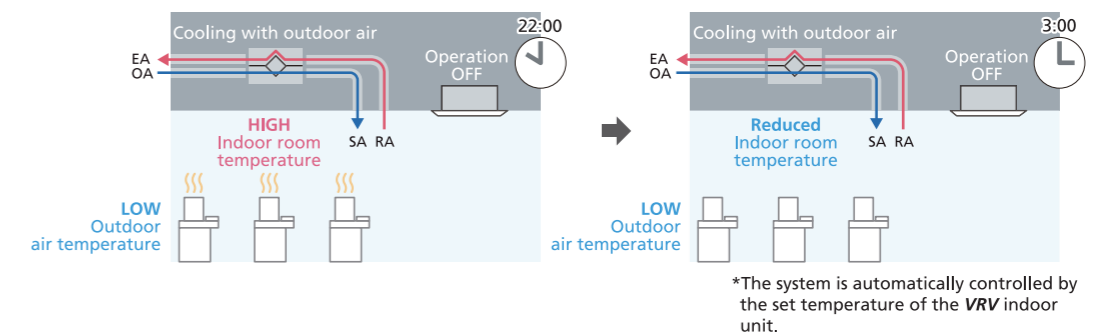

### CO<sub>2</sub> sensor control (Option) \*Refer to pages 185 for details.

When CO<sub>2</sub> sensor is installed, it detects the concentration of CO<sub>2</sub> in the indoor air and the Ventilation rate is controlled appropriately, reducing the air conditioning load due to ventilation.

### Improvement of IEQ (Indoor Environmental Quality)

#### PM2.5 filter (Option) \*Refer to pages 186 - 188 for details.

Removes PM2.5 particulate matter present in the outdoor air, as well as sulfur oxides and nitrogen oxides, providing clean fresh air to the indoor ambient.

- PM2.5 filter: Removes 99% or more of 2.5 μm particulate matter.
- Activated Carbon filter: Removes sulfur oxides and nitrogen oxides.

### Fresh Air Comfort

Round Flow Cassette indoor units can be connected to a duct to provide fresh outdoor air for comfortable air from the air conditioner. Installation is also possible for existing indoor units.

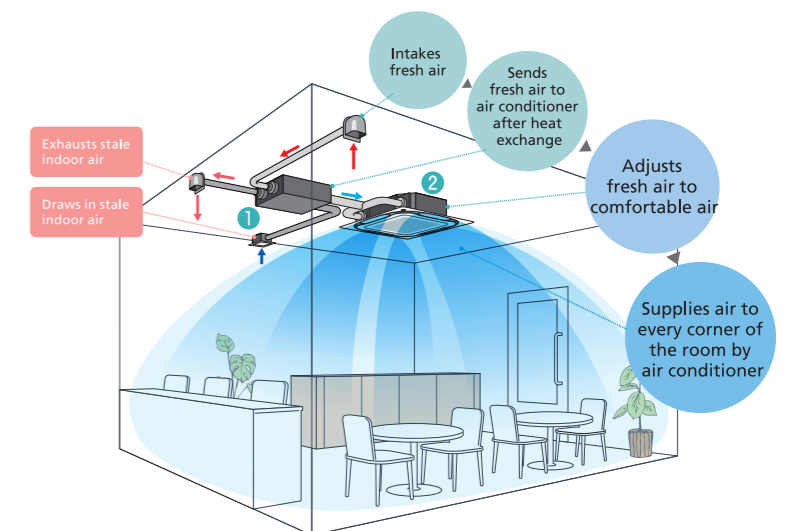

- 1 Heat Reclaim Ventilator
- 2 Round Flow Cassette (including with sensing type)

# Air Treatment Equipment



## Heat Reclaim Ventilator

### Specifications

Model			VAM150HVE	VAM250HVE	VAM350HVE	VAM500HVE	VAM650HVE	VAM800HVE	VAM1000HVE	VAM1500HVE	VAM2000HVE	
Power Supply			Single phase, 220-240 V/220 V, 50/60 Hz									
Temperature exchange efficiency (50/60 Hz)	For Cooling	Ultra-High	66.0/66.0	60.5/60.5	65.0/65.0	61.5/61.5	59.5/59.5	61.5/61.5	58.0/58.0	61.5/61.5	58.5/58.5	
		High	66.0/66.0	60.5/60.5	65.0/65.0	61.5/61.5	59.5/59.5	61.5/61.5	58.0/58.0	61.5/61.5	58.5/58.5	
		Low	69.0/69.5	65.0/65.5	70.0/70.0	63.0/64.0	62.5/63.0	64.0/65.0	61.5/62.0	65.5/66.0	65.5/65.5	
Enthalpy exchange efficiency (50/60 Hz)	For Cooling	Ultra-High	63.5/63.5	60.0/60.0	62.5/62.5	62.5/62.5	60.0/60.0	63.0/63.0	60.0/60.0	63.0/63.0	60.0/60.0	
		High	63.5/63.5	60.0/60.0	62.5/62.5	62.5/62.5	60.0/60.0	63.0/63.0	60.0/60.0	63.0/63.0	60.0/60.0	
		Low	66.0/66.5	61.5/62.0	64.5/65.0	64.0/65.0	62.5/63.0	64.5/65.5	62.0/62.5	65.5/66.0	64.5/64.5	
Power Consumption (50/60 Hz)	Heat exchange mode	Ultra-High	96-103/132	126-141/172	178-193/231	296-326/390	381-426/472	664-684/829	683-736/883	1,274-1,353/1,645	1,365-1,471/1,763	
		High	90-93/118	114-123/144	163-170/207	248-261/329	307-319/413	603-612/712	621-656/763	1,207-1,225/1,423	1,241-1,311/1,526	
		Low	68-73/67	75-83/79	132-142/145	223-233/268	264-276/332	504-544/562	539-569/594	1,008-1,089/1,125	1,079-1,138/1,188	
	Bypass mode	Ultra-High	96-103/132	126-141/172	178-193/231	296-326/390	381-426/472	664-684/829	683-736/883	1,274-1,353/1,645	1,365-1,471/1,763	
		High	90-93/118	114-123/144	163-170/207	248-261/329	307-319/413	603-612/712	621-656/763	1,207-1,225/1,423	1,241-1,311/1,526	
		Low	68-73/67	75-83/79	132-142/145	223-233/268	264-276/332	504-544/562	539-569/594	1,008-1,089/1,125	1,079-1,138/1,188	
Sound Level (50/60 Hz)	Heat exchange mode	Ultra-High	33.0-34.0/34.0	33.0-34.0/33.5	32.0-33.0/34.5	36.0-37.0/38.5	37.5-38.0/38.0	41.5-42.5/41.0	42.0-43.0/42.5	43.0-44.0/44.0	43.5-44.0/44.5	
		High	30.5-32.0/28.0	31.5-32.5/28.0	30.0-31.5/27.5	35.0-36.0/35.0	36.0-36.5/37.0	39.5-41.0/37.0	40.0-41.0/38.0	41.0-42.5/39.0	41.5-43.0/40.0	
		Low	23.0-25.5/20.0	23.0-25.5/21.0	26.5-28.5/22.0	32.0-34.0/31.0	34.0-35.0/32.5	36.0-38.5/33.0	38.0-39.5/34.5	38.0-40.5/35.0	39.0-41.0/36.5	
	Bypass mode	Ultra-High	33.5-34.0/36.0	33.0-34.0/34.5	32.5-33.5/34.5	36.0-37.0/38.5	39.5-40.0/42.0	41.5-42.5/41.0	42.0-43.0/42.5	43.0-44.0/44.0	43.5-44.0/44.5	
		High	31.5-33.0/28.5	31.0-32.5/29.0	31.0-32.0/27.5	35.0-36.0/35.0	38.0-38.5/39.0	39.5-41.0/37.0	40.0-41.0/38.0	41.0-42.5/39.0	41.5-43.0/40.0	
		Low	23.0-25.5/20.5	23.5-25.5/21.5	27.0-29.0/23.0	32.0-34.0/31.0	35.5-36.5/33.5	36.0-38.5/33.0	38.0-39.5/34.5	38.0-40.5/35.0	39.0-41.0/36.5	
Casing			Galvanised steel plate									
Insulation Material			Self-extinguishable polyurethane foam									
Dimensions (H x W x D)			mm			278 x 551 x 810	306 x 800 x 879	338 x 832 x 973	387 x 1,012 x 1,110	785 x 1,012 x 1,110		
Machine Weight			kg			22	31	41	43	63	133	
Heat Exchange System			Specially processed nonflammable paper									
Heat Exchange Element Material			Multidirectional fibrous fleeces									
Fan	Type	Sirocco fan										
		Airflow Rate (50/60 Hz)	Ultra-High	150/150	250/250	350/350	500/500	650/650	800/800	1,000/1,000	1,500/1,500	2,000/2,000
	External static pressure (50/60 Hz)	High	150/150	250/250	350/350	500/500	650/650	800/800	1,000/1,000	1,500/1,500	2,000/2,000	
		Low	100/80	165/145	275/235	470/420	570/495	720/610	880/835	1,350/1,250	1,650/1,580	
	Motor Output	Ultra-High	125-140/155	115-130/135	170-185/230	165-190/245	185-190/260	210-235/250	205-225/220	195-215/235	190-210/210	
		High	100-120/100	80-90/60	145-165/80	140-175/180	140-155/210	170-215/140	155-195/100	150-180/125	140-180/85	
Unit ambient condition			-15°C to 50°CDB, 80%RH or less									

- Notes:
- Airflow rate can be changed over to Low mode or High mode.
  - Temperature Exchange Efficiency is the mean value between cooling and heating.
  - Efficiency is measured under the following conditions: Ratio of rated external static pressure has been maintained as follows; outdoor side to indoor side = 7 to 1.
  - In conformance with JIS standards (JIS B 8628), operating sound level is based on the value when one unit is operated, with the value converted for an anechoic chamber. This is transmission sound from the main unit, and does not include sound from the discharge grille. Thus it is normal for the sound to be louder than the indicated value when the unit is actually installed.

### Remote controller function for Heat Reclaim Ventilator

Function	Detail	BRC1H63W(K)	BRC1E63	BRC2E61
				
Air conditioner interlock	Interlock Heat Reclaim Ventilator with air conditioner by one remote controller	●	●	●
Ventilation mode	Switch the ventilation mode (Automatic, Heat exchange, Bypass)	●	●	—
Ventilation airflow rate	When using CO <sub>2</sub> sensor, ventilation volume can be changed	●	●	●
Fresh up indication	Indicates that fresh up operation is being carried out	●	—	—
CO <sub>2</sub> indication	Indicates value of CO <sub>2</sub> sensor	○	—	—
Outdoor temperature indication	Indicates outdoor air temperature (OA)	○	—	—
Nighttime free cooling indication	Indicates that night purge operation is set	○	—	—
24 hour ventilating indication	Indicates that 24 hour ventilating operation is set	○	—	—
Ventilating operation indication	Indicates that ventilating operation is being carried out even when night purge operation and 24 hour ventilating operation is being carried out	●	●	—
Ventilating standby indication	Indicates that ventilating operation has been stopped temporarily during pre-cool / pre-heat control	○	—	—
Sharing CO <sub>2</sub> data	Share the CO <sub>2</sub> data to submit from main unit with in the group	○	—	—

○ : New functions / ● : Installed functions

### Options

Item	MODEL	VAM150HVE	VAM250HVE	VAM350HVE	VAM500HVE	VAM650HVE	VAM800HVE	VAM1000HVE	VAM1500HVE	VAM2000HVE
Additional function	Silencer	—								
	Nominal pipe	mm								
	High efficiency filter	KAF242J25M			KAF242J50M	KAF242J65M		KAF242K100M		KAF242K100M x 2
Flexible duct (1m)	Air filter for replacement	KAF241L25M			KAF241L35M	KAF241L65M		KAF241L100M		KAF241L100M x 2
		K-FDS101E			K-FDS151E	K-FDS201E		K-FDS251E		
Flexible duct (2m)		K-FDS102E			K-FDS152E	K-FDS202E		K-FDS252E		
CO <sub>2</sub> sensor*2		BRYC24A25M			BRYC24A35M	BRYC24A65M		BRYC24A100M		
Humidity sensor		BRYH241A100 (for RA) / BRYH242A100 (for OA)								
PM2.5 filtration unit*3		BAF249A150	BAF249A300	BAF249A350	BAF249A500		BAF249A20A		BAF429A20A	
PM2.5 with activated carbon filtration unit*3		BAF249A150C	BAF249A300C	BAF249A350C	BAF249A500C		BAF429A20AC			
Streamer duct chamber		BDEZ500A60VE			BDEZ500A140VE	BDEZ500A140VE		BDEZ500A510VE		
Wired remote controller		BRC1H63W (White) / BRC1H63K (Black) / BRC1E63 / BRC2E61								
Controlling device	Central remote controller	DCS303A51*1								
	Central remote controller	DCS302CA61								
	Unified ON/OFF controller	DCS301BA61								
	Schedule timer	DST301BA61								
	Wiring adaptor for electrical appendices	KRP2A62								
PCB Adaptor	Installation box for adaptor PCB	KRP1C18A90								
	For heater control kit	BRP4A50A								
	PCB adaptor for wiring	KRP1C18								

- Notes: \*1. For residential use only. When connect with a Heat Reclaim Ventilator (VAM), you can only switch the power ON/OFF. It cannot be used with other central control equipment.  
\*2. Refer to pages 185 for details. \*3. Refer to pages 186 - 188 for details.

### PCB adaptor for heater control kit [BRP4A50A] (Option)

When the installation of an electric heater is required in a cold region, this adaptor with an internal timer function eliminates the complicated timer connecting work that was necessary with conventional heaters.

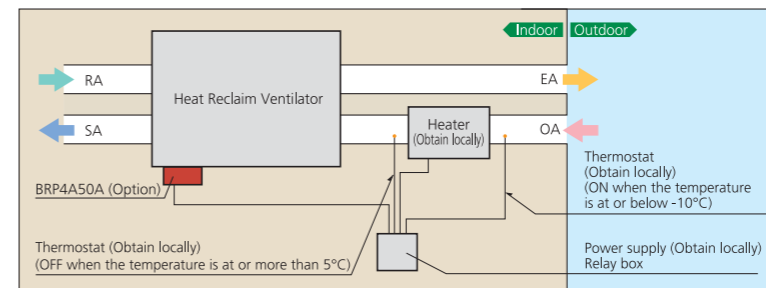

- Notes when installing :
- Examine fully an installation place and specification for using the electric heater based on the standard and regulation of each country.
  - Supply the electric heater and safety production devices such as a relay and a thermostat, etc of which qualities satisfy the standard and regulation of each country at site.
  - Use a non-inflammable connecting duct to the electric heater. Be sure to use 2 m or more between the electric heater and the Heat Reclaim Ventilator for safety.
  - For the Heat Reclaim Ventilator, use a different power supply from that of the electric heater and install a circuit breaker for each.

# Air Treatment Equipment

## Airflow rate control with CO<sub>2</sub> sensor (Option) for VAM / VKM series

The CO<sub>2</sub> sensor controls airflow rate so that it best matches the changes of CO<sub>2</sub> level in the room. This prevents energy losses from over-ventilation while maintaining indoor air quality with optional CO<sub>2</sub> sensor.

● Example of CO<sub>2</sub> sensor operation in an office room:

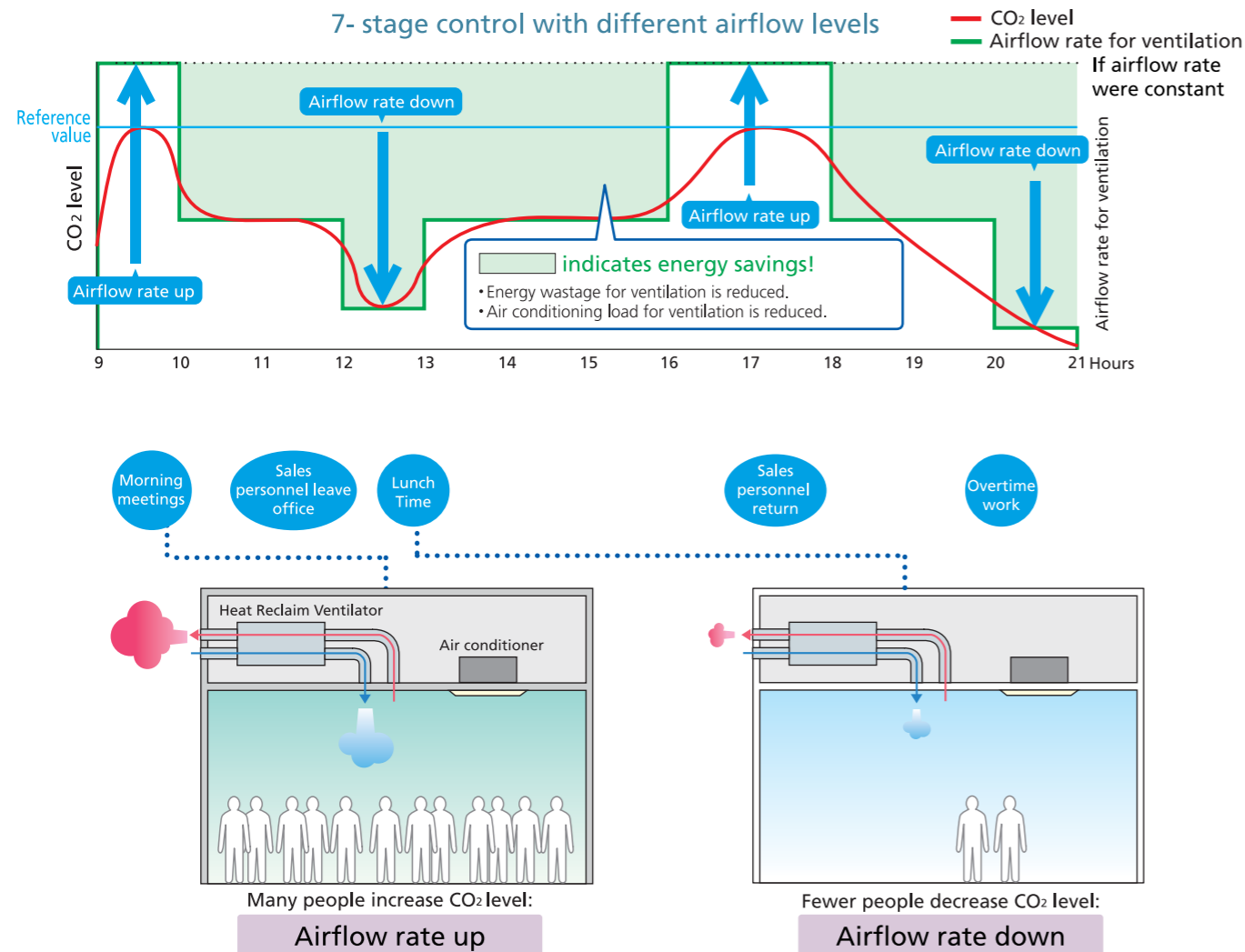

## PM2.5 filtration unit (Option) for VAM / VKM series

Rapid urbanization has increased industrial and automobile emissions, resulting in higher PM2.5 levels. This has become the source of respiratory diseases and poses a serious threat to a long term health issue. As the air quality has worsened, research has shown the harmful effects of PM2.5 on the health of the general public.

### Double-layered efficient filtration

PM2.5 filters are double-layered.

1. The front filter effectively removes large particles.
2. The PM2.5 filter layer contains a large amount of static electricity to capture particulate matter efficiently.



### Filtering PM2.5 efficiently for healthier and more comfortable environments

This filter removes 99% or more of 2.5 μm particulate matter.

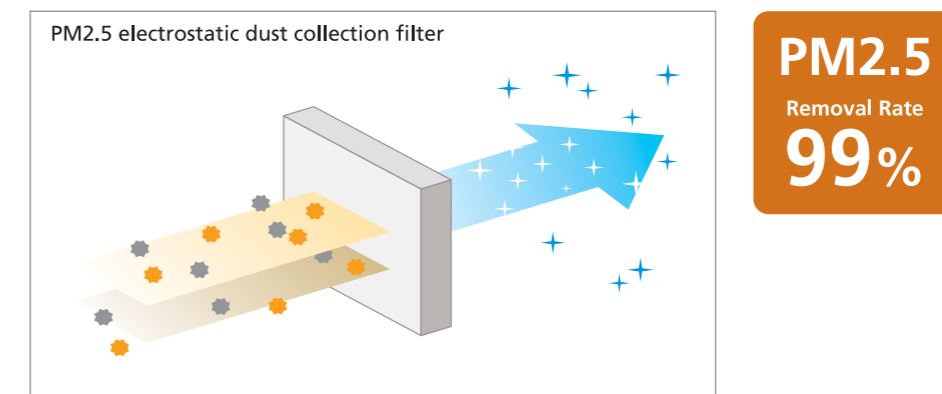

\*Test results by the Heating, Ventilation and Air Conditioning Lab at Tongji University  
Test environment: temperature 25-26°CDB, humidity 58-60%RH

# Air Treatment Equipment

## Electrostatic dust collection filter: more efficient and longer lasting effect

The PM2.5 filter layer contains a large amount of static electricity to capture particulate matter efficiently, including those smaller than the grid mesh. The filter is difficult to be blocked by particles and has good ventilation and long life span.

**Daikin Electrostatic Dust Collecting Filtration**

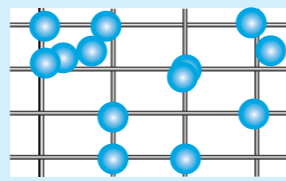

With the capturing effect of static electricity, particles are adsorbed on the filter fabric.



The filter is not blocked and therefore continuous Supply Air is guaranteed.

▼

Long-lasting highly efficient dust collection capacity

## PM2.5 with activated carbon filtration unit (Option) for VAM / VKM series

Extra-high performance filter against sulfur oxides and nitrogen oxides

### Effective Use of Active Carbon Material to Enlarge the Adsorption Area

As an expert in the research and development of filters, DAIKIN has specifically selected active carbon material as the main substance to constitute the filter against sulfur oxides and nitrogen oxides. The material's usable pore surface is fully exploited, thus extending the filter's durability.

Notes: Surface area of active carbon: 700 m<sup>2</sup>/g  
Given a newspaper page of 40.6 cm wide by 54.6 cm long, each gram of active carbon has a surface area of 3,000 newspaper pages.

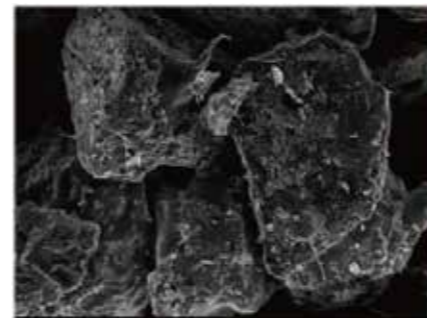

### Intelligent Identification, Super-effective Adhesion

The special substance added in the pores of active carbon can exclusively target sulfur oxide and nitrogen oxide gases and stick to them without blocking other unidentified gases. This ensures long durability of the filter.

Note: The figures are based on in-house tests under the following lab conditions: temperature 22 to 25°CDB, humidity 35 to 40% RH, air flow rate 0.2 m/s.

Unidentified Gases

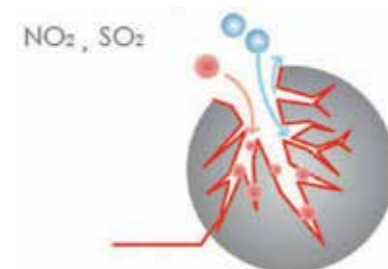

## Specifications

### PM2.5 filtration unit

MODEL		BAF249A150	BAF249A300	BAF249A350	BAF249A500	BAF429A20A
Dimensions (H × W × D)	mm	220×603×366	220×603×366	300×623×366	300×623×366	470×971×370
Connection Duct Diameter	mm	φ 100	φ 150	φ 150	φ 200	580×348
Airflow Rate	m <sup>3</sup> /h	150	250	350	500	2,100
PM2.5 Filter	Initial Pressure Drop	Pa	34	30	31	42
	Filter Lifetime <sup>*1</sup>		1 year			
	Filtration Efficiency <sup>*2</sup>		99% or higher			
	Filter Material No. <sup>*3</sup>		BAF244A300		BAF244A500	BAF424A20A

Notes: 1. Annual usage: 400 hrs/month × 12 months = 4,800 hrs  
2. 99% or higher removal rate of ultra-fine particles with diameters of 2.5 μm or more.  
3. Filters come with applicable filtration units with a one-year life. They can be purchased and replaced according to their model numbers.

### PM2.5 with activated carbon filtration unit

MODEL		BAF249A150C	BAF249A300C	BAF249A350C	BAF249A500C	BAF429A20AC
Dimensions (H × W × D)	mm	220×603×366	220×603×366	300×623×366	300×623×366	470×971×370
Connection Duct Diameter	mm	φ 100	φ 150	φ 150	φ 200	580×348
Airflow Rate	m <sup>3</sup> /h	150	250	350	500	2,100
Total Initial Pressure Drop for PM2.5 with Activated Carbon Filtration Unit	Pa	37	35	36	51	less than 50
PM2.5 Filter	Initial Pressure Drop	Pa	34	30	31	42
	Filter Lifetime <sup>*1</sup>		1 year			
	Filtration Efficiency <sup>*2</sup>		99% or higher			
	Filter Material No. <sup>*3</sup>		BAF244A300		BAF244A500	BAF424A20A
Activated Carbon Filter	Initial Pressure Drop	Pa	3	5	5	9
	Filter Lifetime		1 year			
	Filter Material No. <sup>*3</sup>		BAF244A300C		BAF244A500C	BAF424A20AC

Notes: 1. Annual usage: 400 hrs / month × 12 months = 4,800 hrs.  
2. 99% or higher removal rate of ultra-fine particles with diameters of 2.5 μm or more.  
3. Filters come with applicable filtration units with a one-year life. They can be purchased and replaced according to their model numbers.



# Control Systems

## Individual control systems for VRV systems

### Stylish remote controller (Option) New



Special Site



White  
BRC1H63W



Black  
BRC1H63K

A complete redesigned controller focused to enhance user experience



reddot design award

### Sleek and stylish design

- Combines refinement and simplicity
- Echoes the distinct blue circle and simplicity of design
- Two attractive colours to match any interior
- Compact, measures only 85 x 85 mm



### User-friendly interface

- Just three buttons and a large-figure display
- Customisable display
- Direct access to basic functions (ON/OFF, Operation mode, Temperature setting, Airflow rate, Airflow direction)
- Timer functions (OFF timer, Weekly schedule timer)
- Simple screen for hotel display



### Easy setting via smartphone application using Bluetooth® wireless technology (for Installer/Facility manager)

## Keep hotel room comfortable

- Improved setback function by setting the lower temperature limit in cooling and higher temperature in heating mode.
- Window/door contact interlock function is available via optional Digital Input Adaptor BRP7A\*.



<App screen image>

## Shorter installation time

- Easy to create multiple remote control and field settings via App
- Prepare a setting in advance at the office and immediately send it to the on-site remote controller
- Save and reuse settings
- Remote update function (OTA: Over The Air)

### Navigation remote controller (Wired remote controller) (Option)



BRC1E63

A series of user friendly functions that can be individually selected

### Energy saving

#### Setpoint range set

- Avoids excessive cooling by limiting the min. and max. set temperature.
- Convenient for use at a place where any number of people may operate it.



#### Setpoint auto reset

- Even if the set temperature is changed, the new set temperature returns to the previous preset value after a preset duration of time.
- Period selectable from 30, 60, 90, or 120 min.



#### Off timer

- Period can be preset from 30 to 180 minutes in 10-minute increments.

### Convenience

#### Setback (default: OFF)

- Maintains the room temperature in a specific range during unoccupied period by temporarily starting air conditioner that was turned OFF.

#### Weekly schedule

- 5 actions per day can be scheduled for each day of the week.
- The holiday function will disable schedule timer for the days that have been set as holiday.
- 3 independent schedules can be set. (e.g. summer, winter, mid-season)



#### Auto display off

- Period can be preset from 10, 30, 60 minutes, and OFF. Initial setting is 30 minutes.

### Comfort

#### Individual airflow direction

- Airflow direction can be individually adjusted for each air discharge outlet.

#### 5-step airflow control

- Airflow rate can be selected from 5-step control.

#### Auto airflow rate

- Airflow rate is automatically controlled.

# Control Systems

## Individual control systems for VRF systems

### ■ Simplified remote controller (Option)



BRC2E61

### Easy operation with new intuitive design

#### Simple operation

Using only six buttons, users have direct access to basic functions. This enables them to easily set comfort to their preference.

- ON/OFF
- Operation mode
- Temperature setting
- Airflow rate (5-step & Auto)\*
- Up and down airflow direction (5-step & Swing)\*
- ON/OFF timer

\* The number of airflow steps and availability of auto airflow rate and swing mode depend on the type of indoor unit.

#### Intuitive design

- By using pictograms, the user-friendly interface enables convenient and easy operation.

#### Compact size

- Measuring only 85 x 85 mm, the new remote controller is extremely compact and complements any interior design.



### ■ Wireless remote controller (Option)



BRC-M series



Signal receiver unit (Installed type)

- The wireless remote controller is supplied in a set with a signal receiver.
- Signal receiver unit of installed type is contained inside decoration panel or indoor unit.
- Shape of signal receiver unit differs according to the indoor unit.

Note: The signal receiver unit shown in the photograph is for mounting inside the decoration panel of FXF(S)Q series.

- Backlight LCD of new wireless remote controller



Pressing the backlight button helps operating in dark rooms.

- A compact signal receiver unit (separate type) to be mounted into a wall or ceiling is included.



BRC-C, E series



Signal receiver unit (Separate type)

\* Wireless remote controller and signal receiver unit are sold as a set except for FXKQ-A series.  
\* Refer to page 230 for the name of each model.

### Wide variation of remote controllers for VRF indoor units

MODEL	FXFTQ	FXFRQ	FXFSQ	FXFQ	FXZQ	FXCQ	FXKQ-A	FXKQ-MA	FXDFQ	FXDBQ	FXDQ	FXSQ	FXMQ	FXHQ	FXAQ	FXL(N)Q	FXVQ	FXB(P)Q
Stylish remote controller (BRC1H63W / BRC1H63K)	●	●	●	●	●	●	●	●	●	●	●	●	●	●	●	●	●	●
Navigation remote controller (BRC1E63)			●	●	●	●	●	●	●	●	●	●	●	●	●	●	●	●
Simplified remote controller (BRC2E61)				●	●	●		●	●	●	●	●	●	●	●	●	●	●
Wireless remote controller* (Installed type signal receiver unit)			●	●	●	●	●							●	●			
Wireless remote controller* (Separate type signal receiver unit)								●	●	●	●	●	●			●		●

\*Refer to page 230 for the name of each model.

### The wired remote controller supports a wide range of control functions

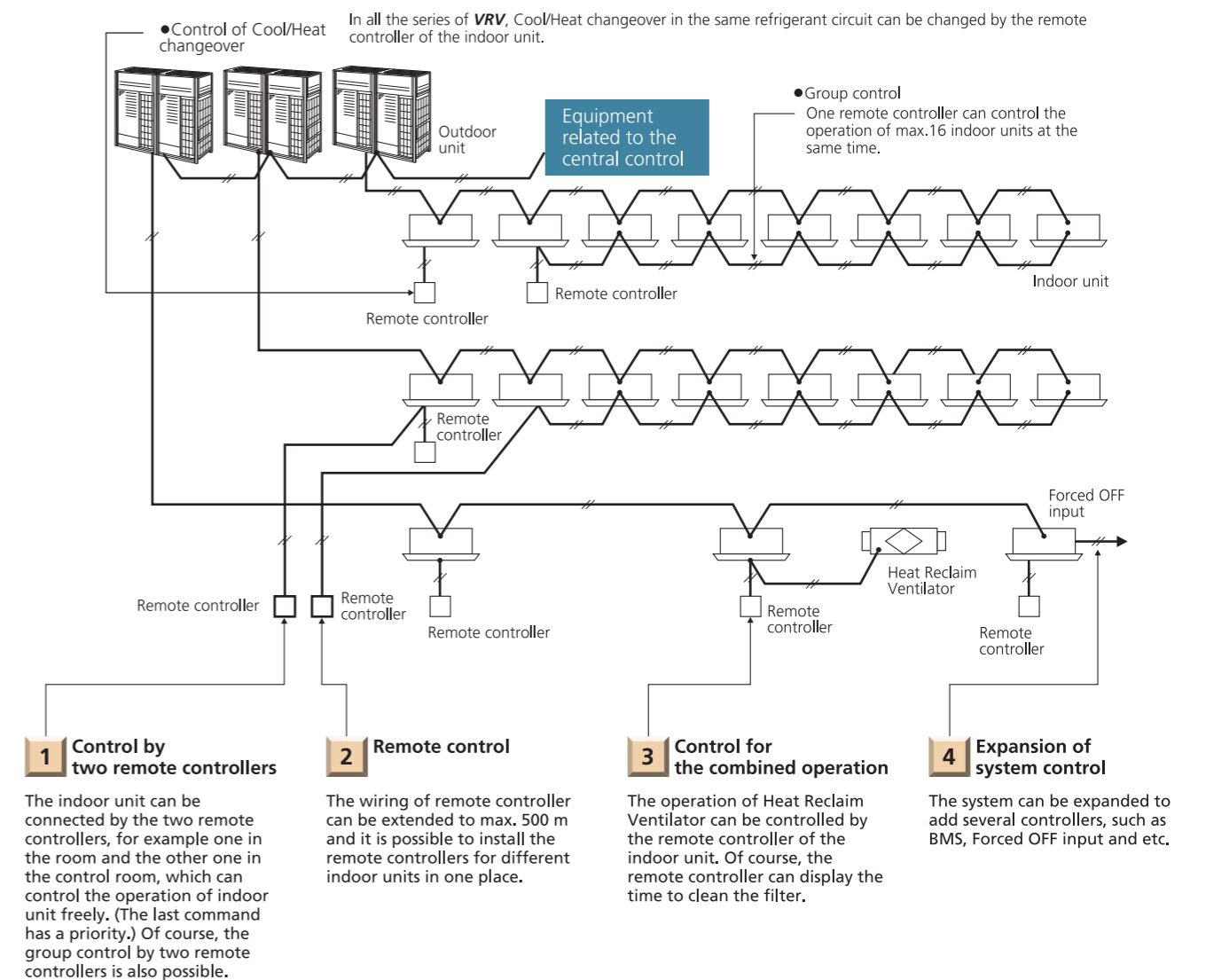

# Control Systems

## Integrated building monitoring system

The high speed transmission of DIII-NET enables more advanced control of the VRV system, providing you with enhanced comfort.

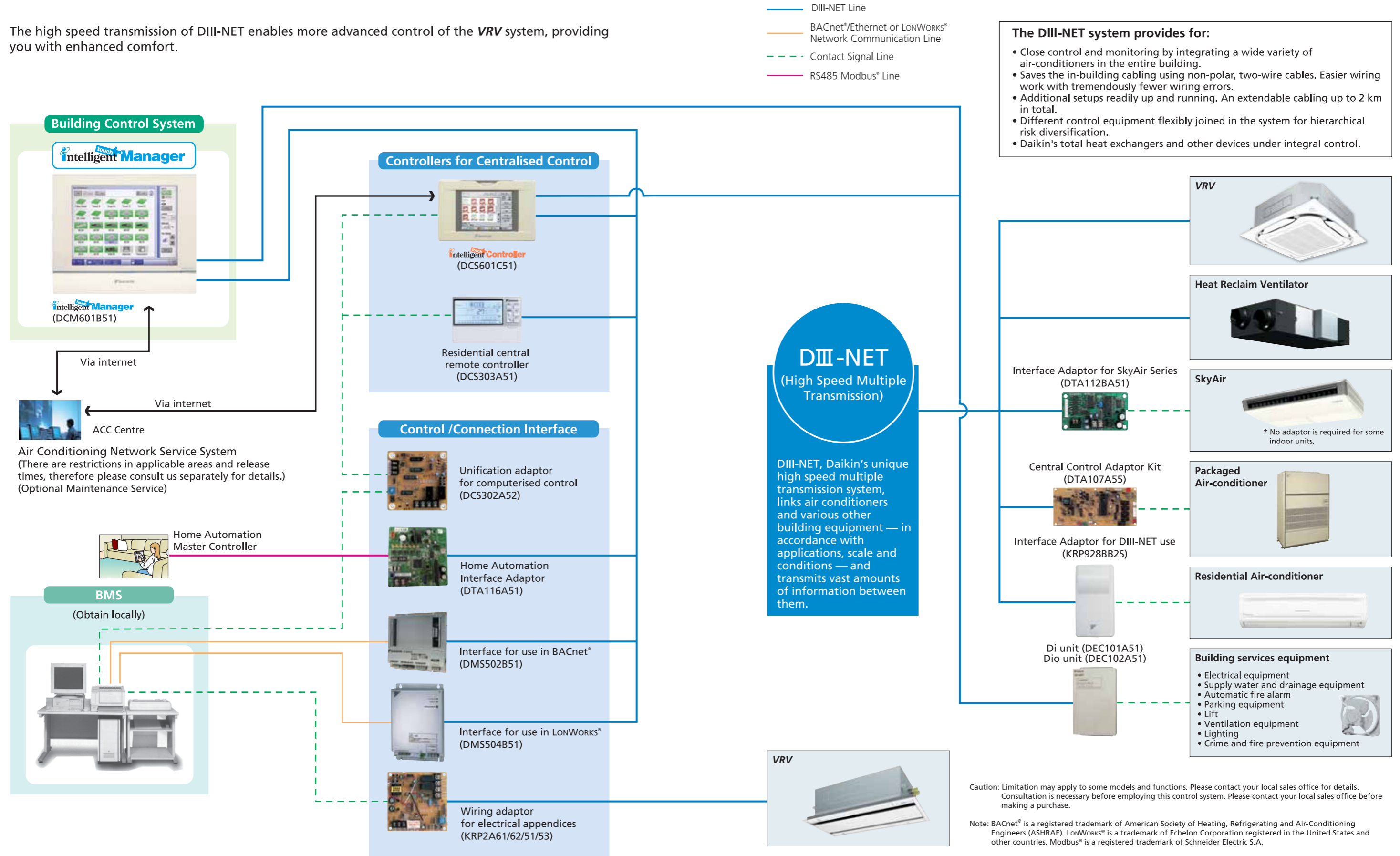

# Control Systems

## Advanced control systems for VRV systems



**Intelligent Touch Manager**  
DCM601B51

Various types of equipment in a building can be controlled by a single controller.

### One touch selection enables flexible control of equipment in a building.

#### Individual air-conditioning control

The flexible control achieved by the VRV system precisely meets different air conditioning needs in each room (e.g. offices, conference rooms, hotel rooms).



#### Lighting control **DALI-compatible**

DALI-compatible LED lighting systems can be controlled and monitored. Lighting control is enhanced through an interlock function with air conditioners and other functions.



#### Air-conditioning control for large spaces

Air handling units can also be controlled. Large spaces, such as entrance halls and shopping malls, can be easily controlled to ensure comfort.

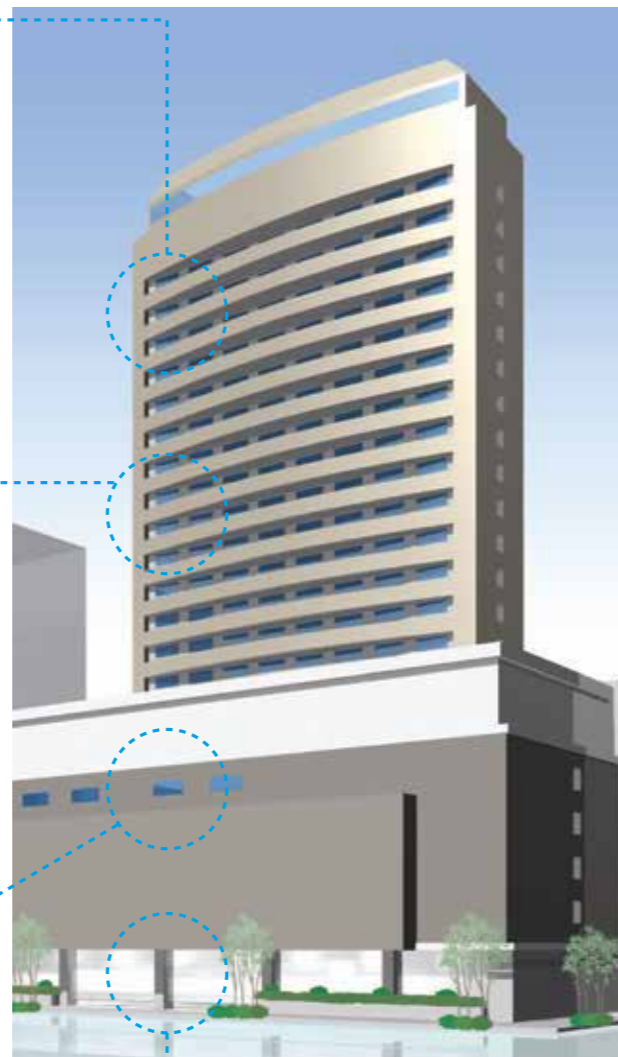

#### Building equipment control

Various types of equipment other than air conditioners, including ventilators, fans, and pumps, can also be controlled.

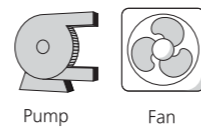

### For energy saving & comfort

*intelligent Touch Manager* maximises the advantages of VRV features

*intelligent Touch Manager* is an advanced multi-zone controller that provides the most cost-effective way to control and monitor the Daikin VRV system.

The 10.4" LCD touch screen is easy to use with three different screen views to include the floor plan layout view, icon view and list view and menus for system configurations.

It is also easy to use with standardized remote Web Access from your PC.

It can manage a total of 650 management points consisting of up to 512 Daikin indoor unit groups (up to 1024 indoor units) along with building equipment control / monitoring with Digital Inputs / Output (Di/Dio), Analog Inputs / Output (Ai/Ao) and Pulse input (Pi) optional devices.

Schedule the operation time for each application.

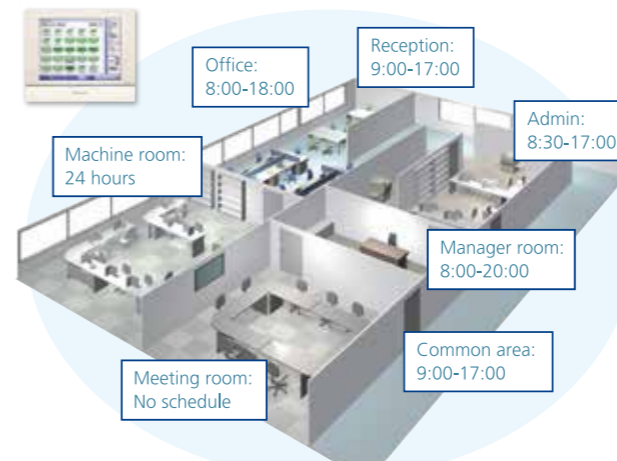

Setting the I-demand function and nighttime quiet operation function is also possible.

Turn the unit OFF if a user didn't.

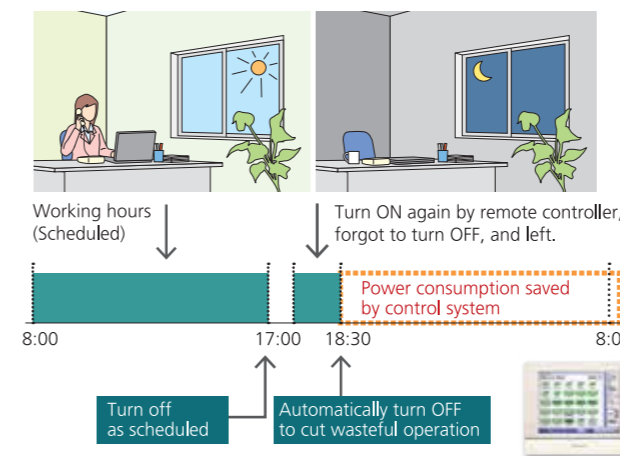

Define the setpoint range that users can change.

With Remote controller



With Control System

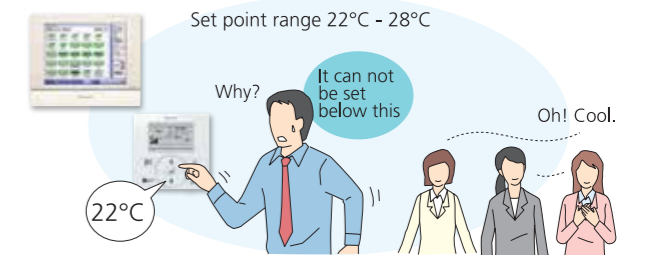

Reset setpoint regularly.

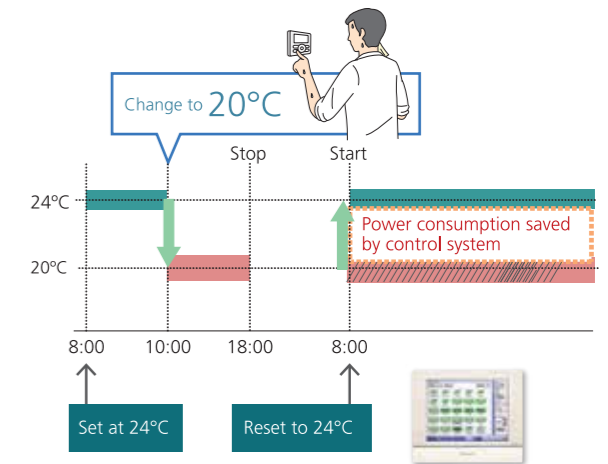

External contact demand control function

This function automatically controls outdoor and indoor unit capacity based on contact signals sent from demand controller (field supply) etc. to save power consumption during peak hours.

- You may set 3 levels that can be switched by ON/OFF signal of 3 contacts
- Control settings are pre-set for each level
- Outdoor unit: I-demand function for peak power limit
- Indoor unit: Set temperature shift, Forced thermostat OFF

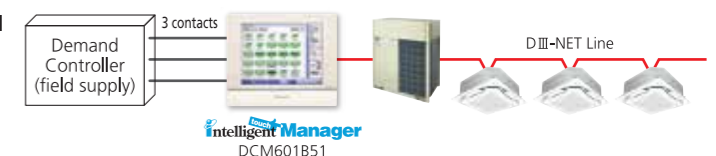

# Control Systems

## Lighting control (Option)

In addition to switching lights on and off, advanced lighting control, such as illuminance adjustment, can be achieved

Connection to DALI-compatible lighting control system

**DALI-compatible**

Please contact your local sales office for details.

Simple wiring (daisy chain) enables management of LED lighting by the *intelligent Touch Manager*. Various air conditioning and lighting control is enabled through the interlock with occupancy sensors and illuminance sensors.

### Lighting control achieved by the *intelligent Touch Manager*

#### [Operation]

- Switch-on/switch-off operation
- Illuminance (1–100%) control
- Various illuminance patterns can be registered
- Registered pattern can be selected from *intelligent Touch Manager*

#### [Monitoring]

- Switch-on/switch-off status monitoring
- Lighting abnormality monitoring
- Illuminance monitoring
- DALI occupancy sensor monitoring
- DALI illuminance sensor monitoring

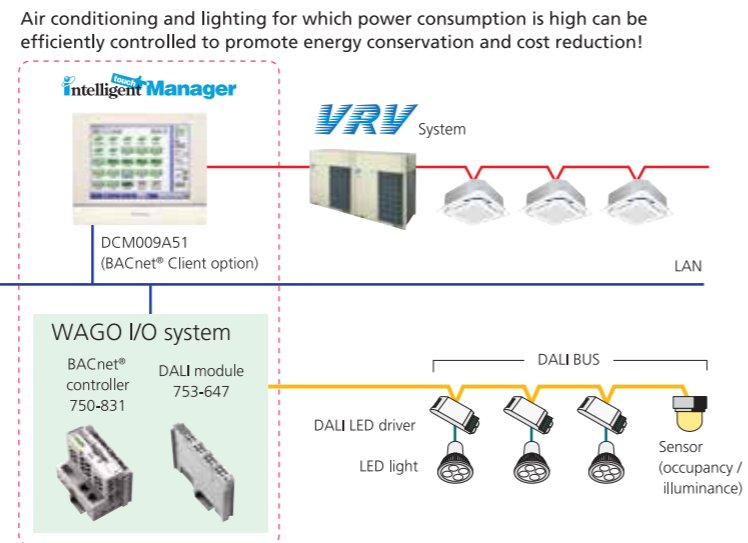

Air conditioning and lighting for which power consumption is high can be efficiently controlled to promote energy conservation and cost reduction!

### Overview of control

- Up to 5 DALI modules can be connected to a single BACnet® controller.
- Up to 64 DALI LED drivers (64 addresses) can be connected to a single DALI module.
- 64 DALI addresses can be freely assigned to up to 16 groups using a single DALI module. (Each group corresponds to a management point of the *intelligent Touch Manager*.)
- Up to 16 scenes can be set to a single DALI module.
- Up to 12 sensors (occupancy, illuminance) can be connected to a single DALI module.
- DALI BUS simplifies wiring and setting work by daisy chain wiring and automatic address setting.

### Easy maintenance and energy saving by lighting control

#### Case 1

Switch-on / switch-off and illuminance are controlled based on a schedule to cut wasteful power consumption.

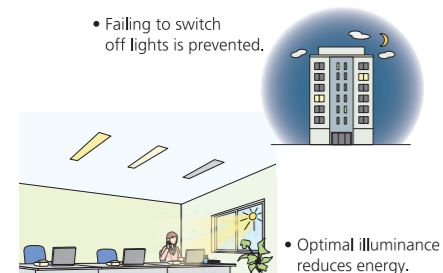

#### Case 2

Occupancy sensors are used to eliminate both wasteful lighting and air conditioning. When a room is unoccupied, the air conditioning stops and the lighting is switched off.

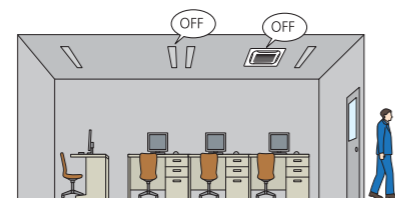

#### Case 3

Lighting abnormalities (e.g. burned-out bulbs) can be checked on the *intelligent Touch Manager* screen.

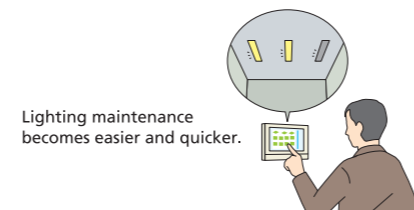

The layout screen enables quick identification of specific locations.

## Tenant management

### Reporting the power consumption of VRV system for each tenant (PPD\* Option)

With the PPD function, power consumption can be calculated for each indoor unit (Option)

The energy consumption is proportionally calculated for each indoor unit. The data can be used for energy management and calculation of air conditioning usage fees for respective tenants.

Operational information of individual indoor units are monitored, based on distribution of power consumption of outdoor units.

Daikin's PPD keeps track of power distribution for each indoor unit. It performs air conditioning billing calculations quickly and automatically.

#### It is easy to output PPD data.

PPD data is output in CSV format to a PC or USB memory device and can be freely processed and managed.

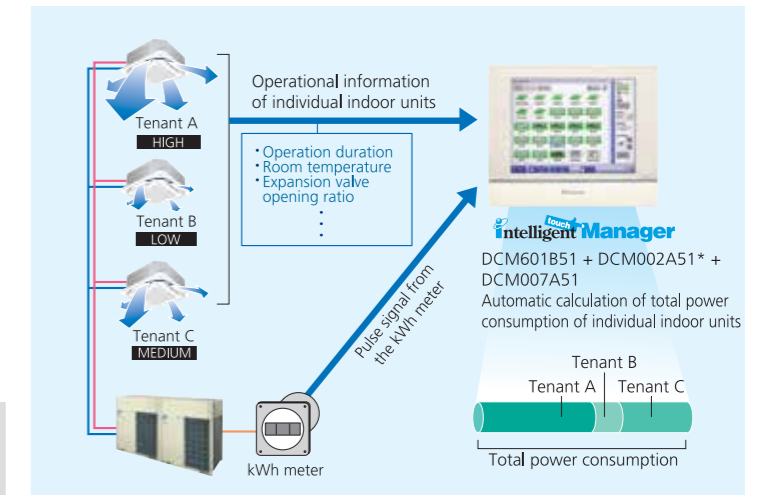

\*PPD (Power Proportional Distribution) is Daikin's proprietary calculation method.

### Air conditioning bills can be issued by one click (PPD\* Option)

Electricity bills can be easily calculated for each tenant (Option)

The power consumption of VRV controlled by the *intelligent Touch Manager* can be easily managed for each tenant using a PC. The electricity bill settings facilitate billing work through easy calculation and issuance of VRV electricity bills.

#### Main functions

- Register tenants
- Set the electricity unit price for 5 time zones
- Calculate power consumption and electricity charge for each tenant
- Show aggregation results in the specified period for each tenant
- Output the results (Printout and CSV file)

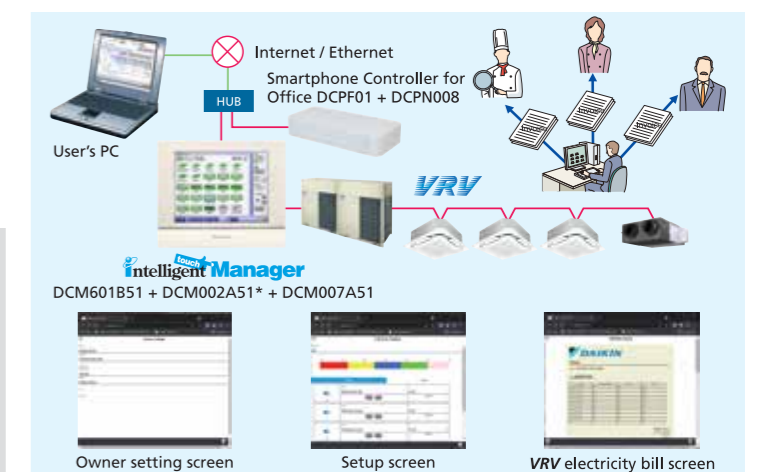

\*PPD (Power Proportional Distribution) is Daikin's proprietary calculation method.

### Effective service functions offered to tenants

Smartphone will be a remote controller of VRV system (Option)

Users can operate and check the status of VRV system from their smartphones via the internet.

It is not necessary to move where a remote controller is located with this feature.

VRV system in other rooms can be operated, and their status can be checked. It is also possible to check if air conditioners in other rooms remain switched on etc., helping achieve energy saving.

#### For buildings VRV Smartphone Remote Controller

Up to 1024 indoor units can be controlled.

Just add Smartphone Controller for Office DCPF01 to this system

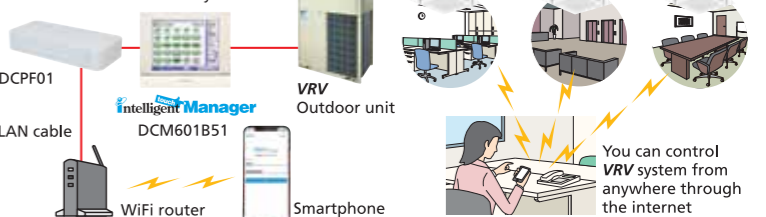

# Control Systems

## intelligent Touch Manager system overview

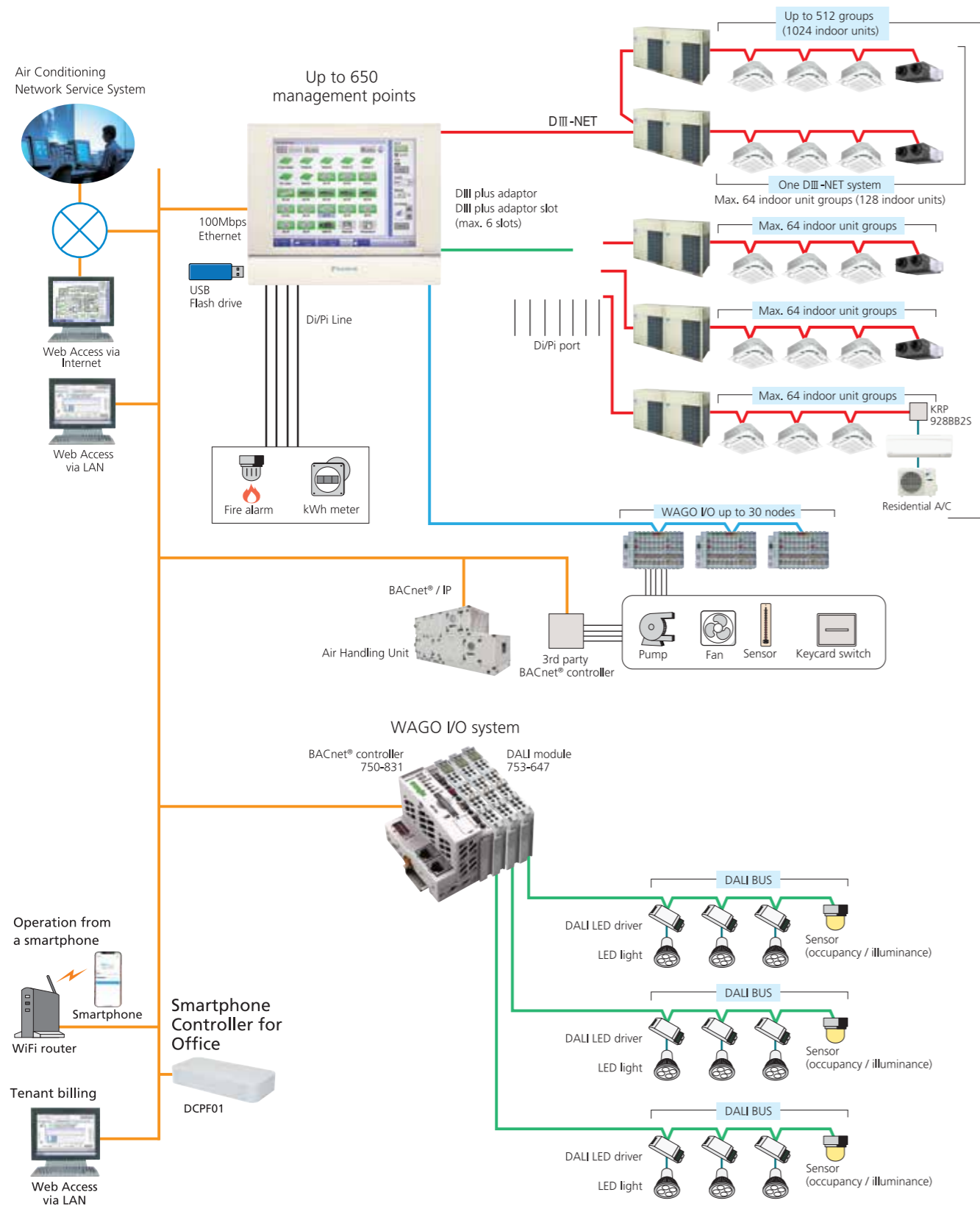

## Air conditioning network service system

### Preventive maintenance

The *intelligent Touch Manager* can be connected to Daikin's own Air Conditioning Network Service System for remote monitoring and verification of operation status for *VRV* system. By its ability to predict malfunctions, this service provides customers with additional peace of mind.

### Enhanced convenience with link to the Air Conditioning Network Service System

The *intelligent Touch Manager* connects seamlessly to Daikin's 24-hour Air Conditioning Network Service System.

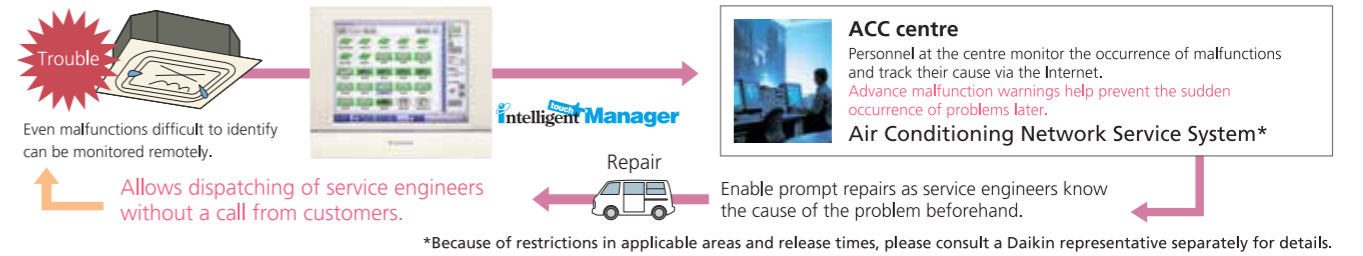

## Daikin offers a variety of control systems

### Convenient controllers that offer more freedom to administrators

#### Ease of use and expanded control functions

The user-friendly controller features colours, multilingual function, and icons in the display for ease of understanding. A wide variety of control methods can be accommodated, permitting administrators to monitor and operate the system even when they are away from the controller.



### Connect VRV system to your BMS via BACnet® or LONWORKS®

Compatible with BACnet® and LONWORKS®, the two leading open network communication protocols, Daikin offers interfaces that provide a seamless connection between *VRV* system and your BMS.

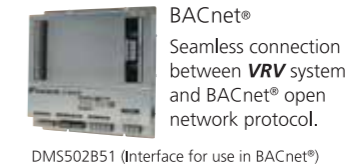

DMS502B51 (Interface for use in BACnet®)  
 DMS504B51 (Interface for use in LONWORKS®)  
 Notes: 1. BACnet® is a registered trademark of American Society of Heating, Refrigerating and Air-Conditioning Engineers (ASHRAE).  
 2. LONWORKS® is a trademark of Echelon Corporation registered in the United States and other countries.

Dedicated interfaces make Daikin air conditioners freely compatible with open networks

## Specialised solution for office, home and hotel with Smartphone Controller Series

### Catering to different applications, ranging from 10 indoor units to 2048 indoor units

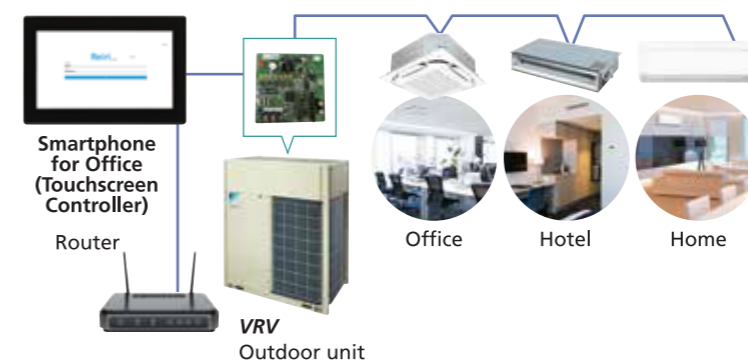

- For Office Building Automation System
- For Home Smart Home Solution
- For Hotel Air Conditioning Guestroom Interlocking Management



- Smartphone Controller for Office (Touchscreen Controller)
- Smartphone Controller for Office (Controller Extension)
- Smartphone Controller for Office (Multisite Extension)
- Smartphone Controller for Home (Lite Version)
- Smartphone Controller for Hotel
- Smartphone Controller for Resort

## Home automation interface adaptor

The **VRV** system can be operated from the home automation system.

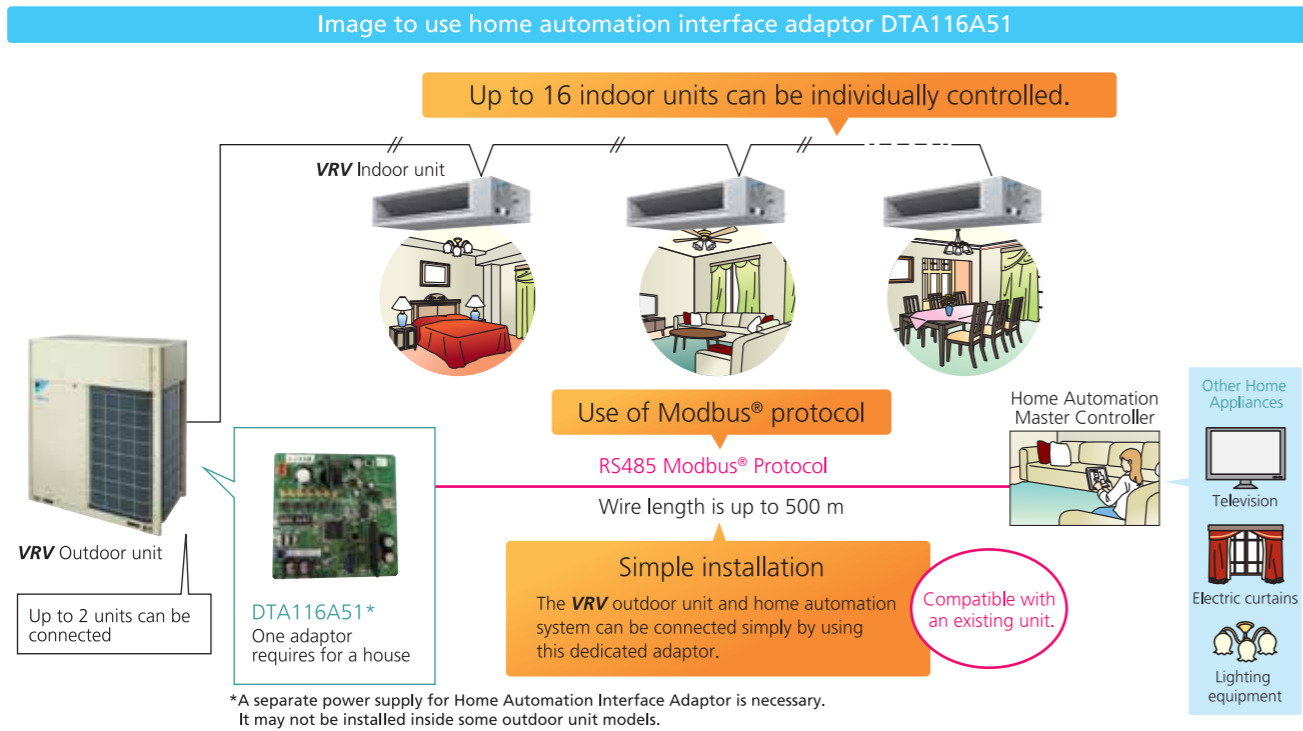

### Functions Monitor

On/Off	On/Off status of indoor units
Operation mode	Cooling, Heating, Fan, Dry, Auto (depend on indoor unit capability)
Setpoint	Setpoint of indoor units
Room temperature	Suction temperature of indoor units
Fan direction	Swing, Flap direction (depend on indoor unit capability)
Fan volume	L, M, H (depend on indoor unit capability)
Forced off status	Forced off status of indoor units
Error	Malfunction, Warning with Error code
Filter sign	Filter sign of indoor units
Communication status	Communication normal/error of indoor units

### Control

On/Off	On/Off control of indoor units
Operation mode	Cooling, Heating, Fan, Dry, Auto (depend on indoor unit capability)
Setpoint	Cooling/Heating setpoint
Fan direction	Swing, Stop, Flap direction (depend on indoor unit capability)
Fan volume	L, M, H (depend on indoor unit capability)
Filter sign reset	Reset filter sign of indoor units

### Retrieve system information

Connected indoor units	DIII-NET address of connected indoor units can be retrieved.
Indoor unit capabilities	Indoor unit capabilities such as operation mode, fan control, setpoint HV can be retrieved.

\* Modbus® is a registered trademark of Schneider Electric S.A.

## Complete control system for VRV systems



### Office Air Conditioning Solution (Smartphone Controller for Office :DCPF01 / Smartphone Controller for Office (Touchscreen Controller) :DCPF04)

A simple office buildings air conditioning solution with a secured, cloud enabled platform, allowing greater ease of control and control while being energy-efficient. The flagship model DCPF04 offers the smart control system with a dedicated touch panel.

### Intelligent Building Solution

- Easy to install and configure with dedicated Configuration Mobile App for installers.
- Remote control operation through mobile App from anywhere.
- Energy management through P.P.D. billing, Energy graph and real time energy display function
- IAQ Management via real time monitoring and trend graph for keeping record.
- Effective Air conditioning usage with setpoint range limitation, set back function, remote control prohibition.

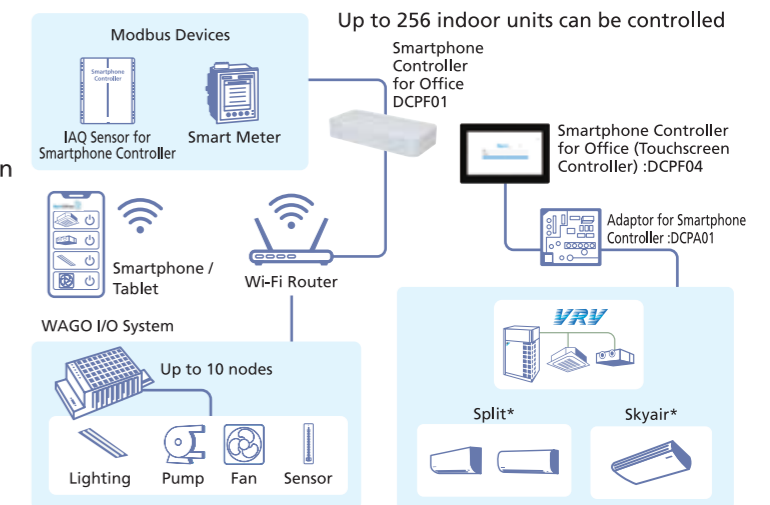

### Specifications

Category	Function	Description
Monitoring & Control	Status monitoring	On/Off, setpoint, operation mode, fan step, flap, error, error code, Room temperature
	Manual Operation	On/off, setpoint, operation mode, fan step, flap, scene control <sup>1</sup>
	Remote control prohibition	Individually prohibit operation of each local remote-control function
	Setpoint range limitation	To limit setpoint range for each indoor unit management point
Automatic Control functions	Automatic changeover <sup>1</sup>	Number of changeover groups: 100
	Off timer	Off timer duration can set from 5min to 120min with every 5min interval
	Setback <sup>1</sup>	Setback setpoint can selected within 24-35°C in cooling mode and 5-20°C in heating mode.
	Schedule	Number of programmes: 100; Up to 20 actions can be registered per pattern.
Data Management	Interlock <sup>1</sup>	Interlock operation depending on equipment status
	History, Report <sup>1</sup>	Operation data (latest information and operation report) and error report on daily/monthly basis.
	Trend graph <sup>1</sup> , energy graph <sup>1</sup>	Chart on environmental changes and energy (and other meter) values.
P.P.D Billing <sup>1,2</sup>	Real time energy display <sup>1,2</sup>	Daily/ Monthly real time energy consumption status on screen.
System Setting	Generate Bill with Power Proportional Distribution data retrieved from the system.	Language, Password setting, Account setting, Notification, Email Notification

<sup>1</sup> Optional software for Smartphone Controller for Office, DCPF01  
<sup>2</sup> Optional software for Smartphone Controller for Office (Touchscreen Controller), DCPF04

# Control Systems

## Office Expanded Solution (Smartphone Controller for Office (Controller Extension) :DCPF05)

A dedicated control solution for large scale office buildings through centralised control of multiple Smartphone Controller for Office controller on a single secured and cloud-enabled platform.

Note: P.P.D. & Tenant Billing Management and Real-Time Energy Monitoring (R.E.M.) are offered as optional software.

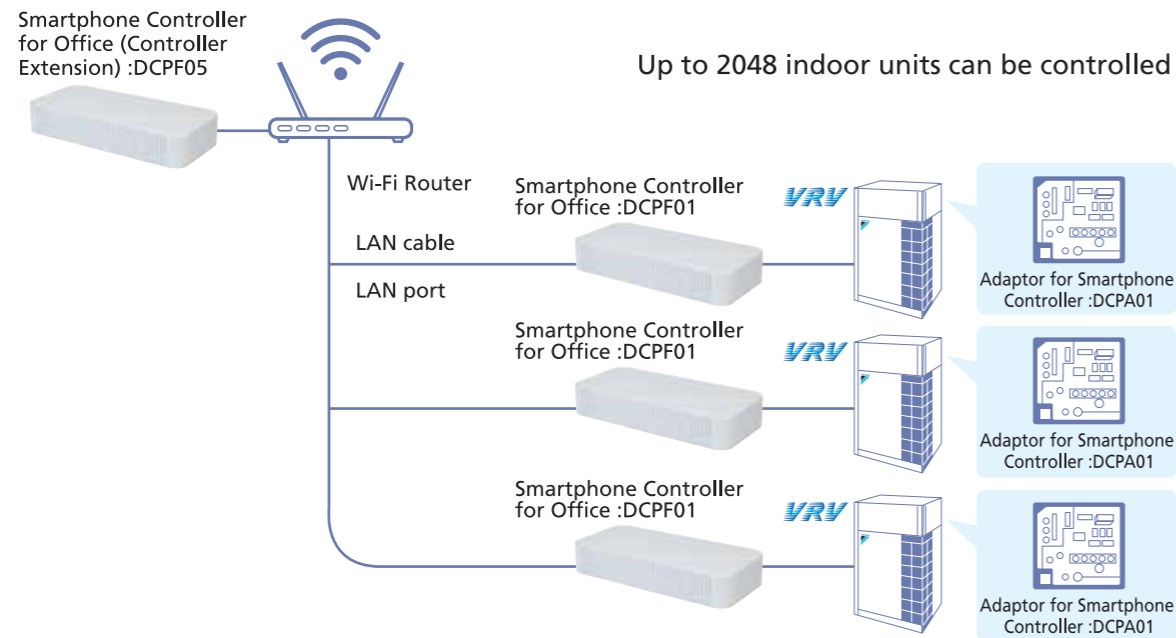

## Multi Site Management Solution (Smartphone Controller for Office (Multisite Extension) :DCPF10)

Centralised control and remote access for all devices in multiple buildings across different locations conveniently located on one secured platform.

Note: Multi-site Branch Expansion is offered as optional software.

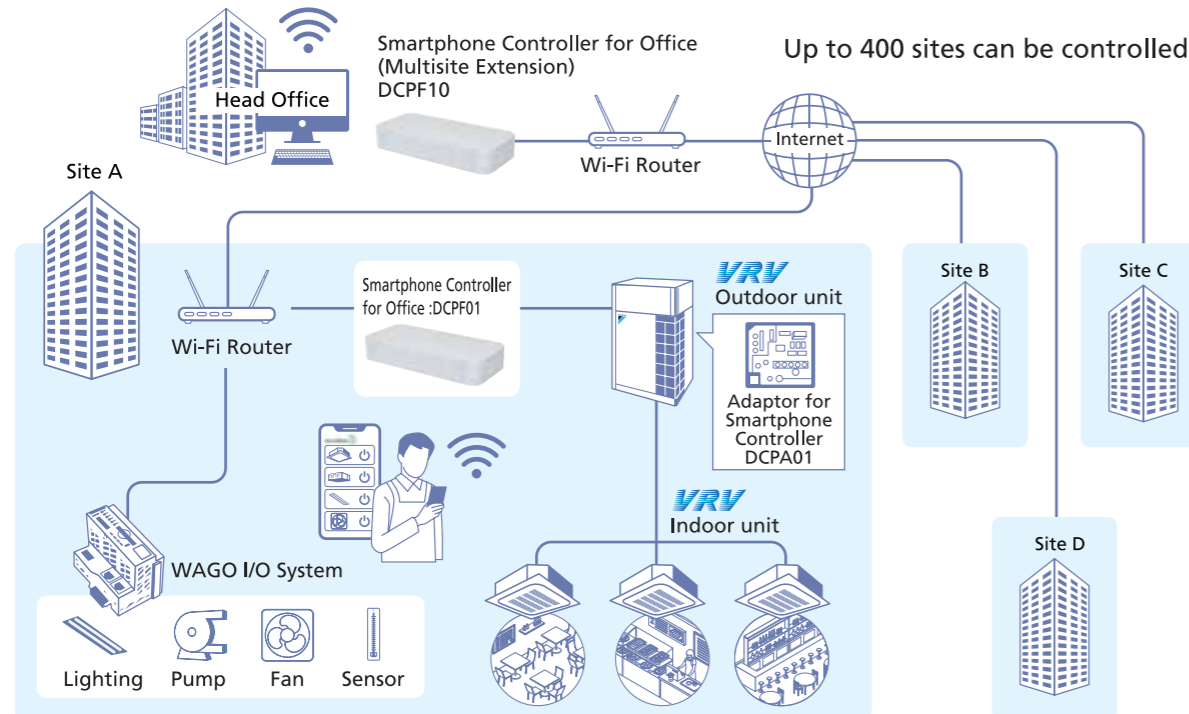

## Smart Home Solution (Smartphone Controller for Home :DCPH01)

The complete smart home air conditioning solution for every homeowners with integration capabilities to allow ease and convenience of control for almost every smart devices

### Complete Smart Home Solution

- Supports Zwave, WAGO, Modbus, LAN communication
- Convenience & Lifestyle
- IAQ Management
- Energy Management
- Home Security Solution
- Google Home Enabled

Note: Residential automatic control and system report is offered as optional software.

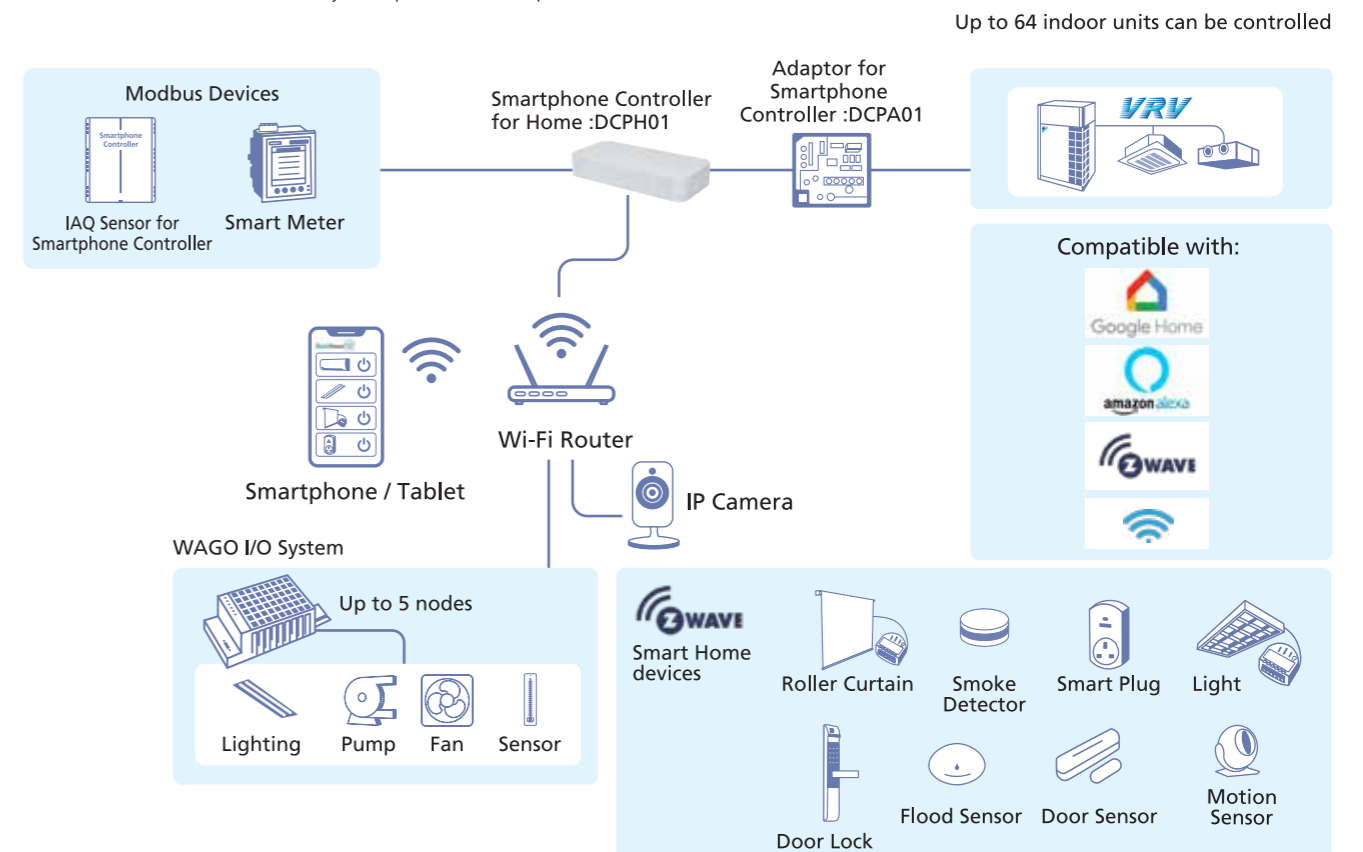

1. Google Home and the Google Home logo are trademarks of Google LLC.
2. Amazon, Alexa and all related logos are trademarks of Amazon.com, Inc. or its affiliates.
3. Z-Wave® is a registered trademark of Sigma Designs and its subsidiaries in the United States and other countries.

## VRV Smart Centralised Control Solution (Smartphone Controller for Home (Lite Version) :DCPH02)

Designed to enhance the comfort and convenience for homeowners, offering complete control of core functions in Daikin Airconditioning system remotely through app access

Note: Residential automatic control and system report is offered as optional software.

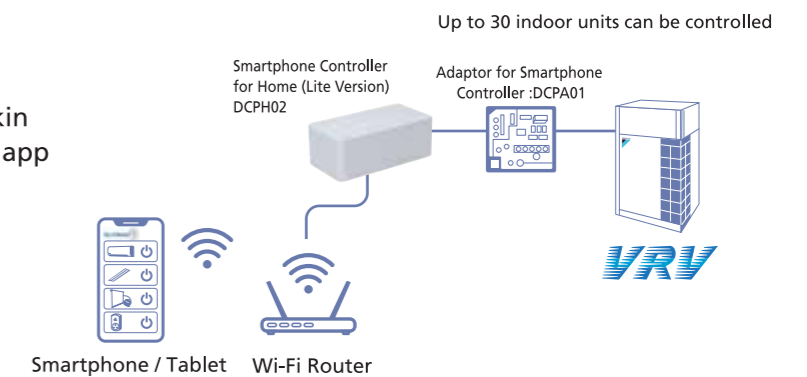



# Control Systems

## Hotel Air Conditioning Solution (Smartphone Controller for Hotel :DCPL01)

The smart hotel air conditioning solution for effective air conditioning operation that maximize guest comfort and minimize energy consumption in a hotel

### Air Conditioning Guestroom Interlocking Management

- Automatic air conditioning control based on check in/out signal, key card signal and window open/close signal
- Guest comfort

Note: The Smartphone Controller for Hotel controller has to be used with Smartphone Controller for Office / Smartphone Controller for Office (Touchscreen Controller) / Smartphone Controller for Office (Controller Extension) controller as building controller.

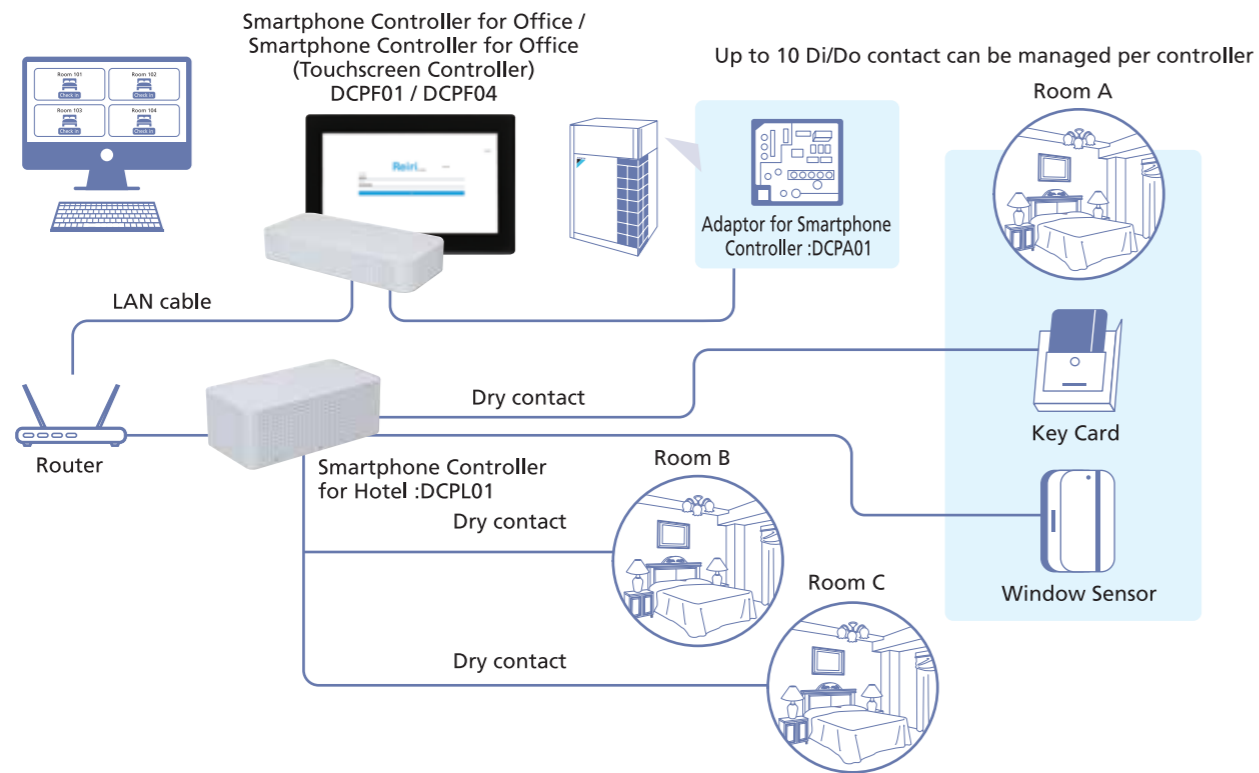

## Villa Air Conditioning Solution (Smartphone Controller for Resort :DCPR01)

Designed to enhance the comfort and convenience for each villa according to use by guests

- Automatic air conditioning control based on check in/out signal, key card signal and window open/close signal
- Guest comfort

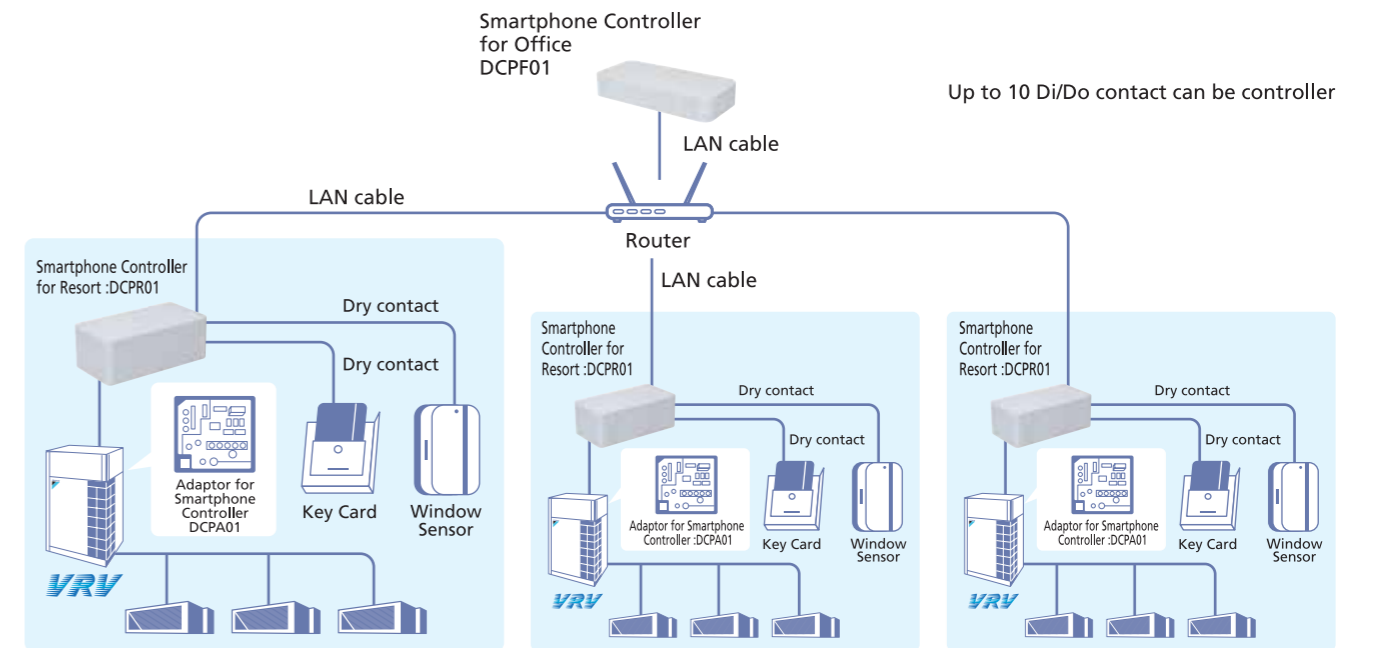

# Streamer Duct Chamber

## New BDEZ-A Series

Utilising Streamer technology to ducted indoor unit



Display panel

### Lineup

Model	BDEZ500A60VE	BDEZ500A140VE	BDEZ500A510VE
Airflow range (CMH)	80-600	500-1400	1200-5100



Presentation Movie

## Filters Mechanism

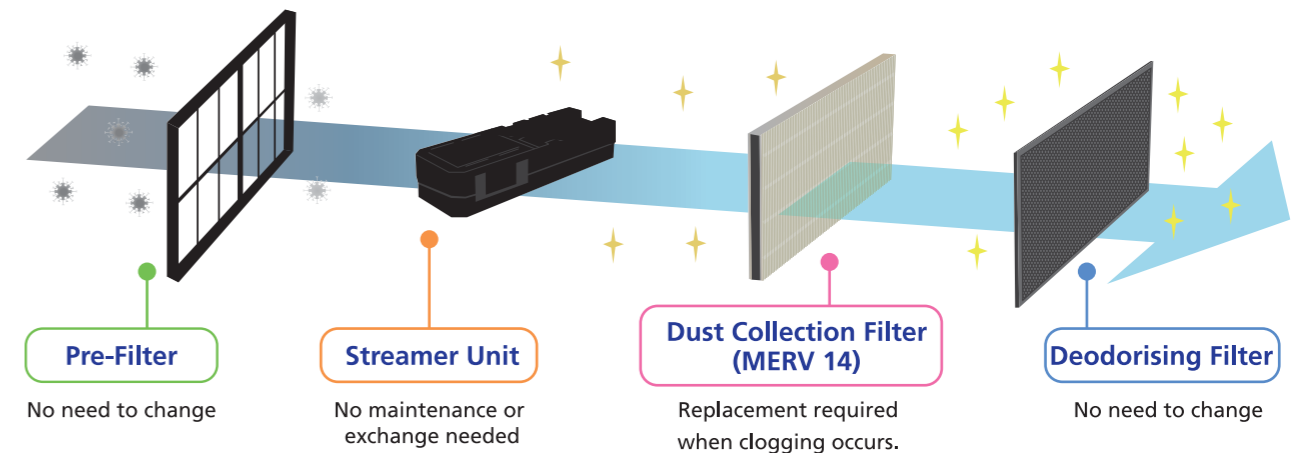

## Streamer Duct Chamber Internal Structure

Dust collection filter (MERV 14) catches bacteria and viruses and prevents them from entering the room.

### Dust Collection Filter (MERV 14)

Particulate matter as small as 2.5 µm (micrometers) can be breathed deep into the lungs. Rest assured that your air remains clean as the filter is able to remove particulate matter as small as PM2.5 with Dust Collection Filter (MERV 14) ratings in accordance to ASHRAE 52.2 Standards.

Product: Streamer Duct Chamber (Line-Up 1,2,3)  
 Testing Organization: Goldensea  
 Test Number: GS-GL-0817-2021-01/02, GS-GL-0818-2021-01  
 Test Method: Filter performance test based on ASHRAE 52.2-2017  
 Test result: The filter meets MERV 14 rating.

Standard 52.2 Minimum Efficiency Reporting Value	Composite Average Particle Size Efficiency, % in Size Range, µm		
	Range 1 (0.3-1.0)	Range 2 (1.0-3.0)	Range 3 (3.0-10.0)
14	75%	90%	95%

### Dust Collection Filter (MERV 14) Replacement Period

Air Quality Condition	Dust concentration (µg/m <sup>3</sup> )		Replacement period
	PM2.5	PM10	
Case 1	18.5	28.5	12 months
Case 2	35	65	6 months

Replace with a new filter when clogging occurs. The left table shows the approximate replacement time when daily operation is 9 hours and annual operation are 240 days. It shows the calculation result for two air conditions. Adjust the replacement timing in consideration of the air environment in the area where the product is actually installed and the time and day it is operated.

## Deodorising Filter

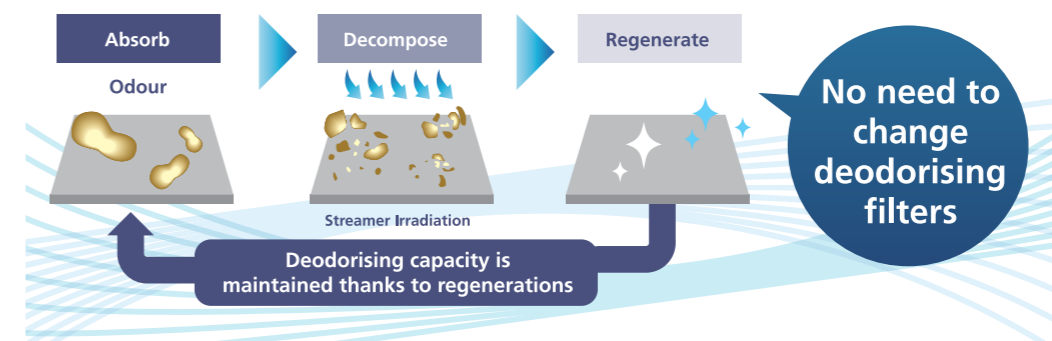

## Streamer Technology



Streamer technology decomposes harmful substances caught by the filter. See page 3-4

Streamer technology is a unique Daikin technology that decomposes viruses, bacteria, allergens such as pollen, hazardous chemical substances such as formaldehyde, and odours with strong decomposing power.

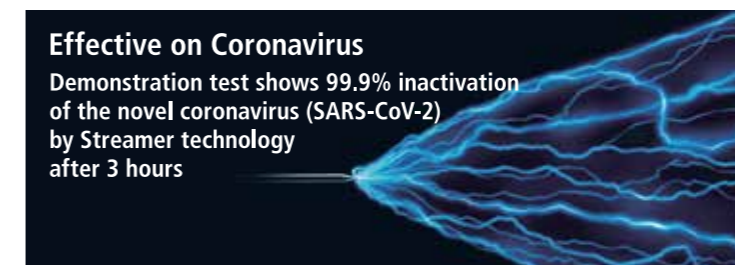

# Streamer Duct Chamber



## Connectable Air Conditioning

Multiple combination of ducted unit

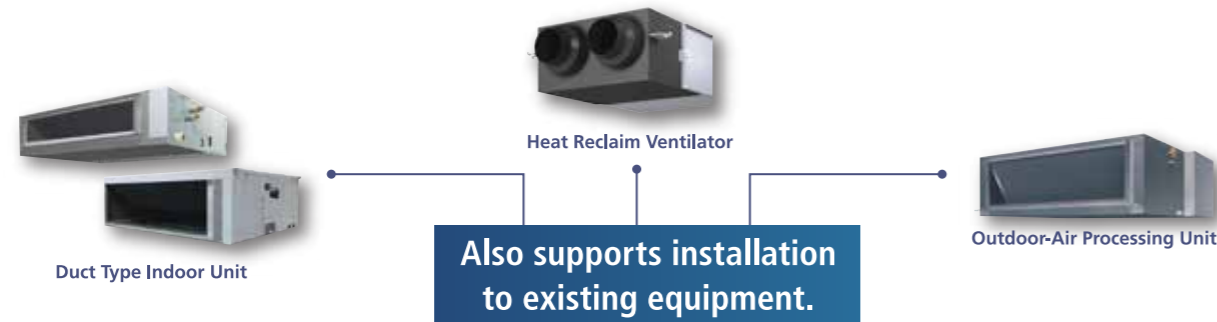

\* Any ducted type indoor units except FXDSQ/FXDQ models are connectable. Refer to option list of indoor unit for details of connected models.

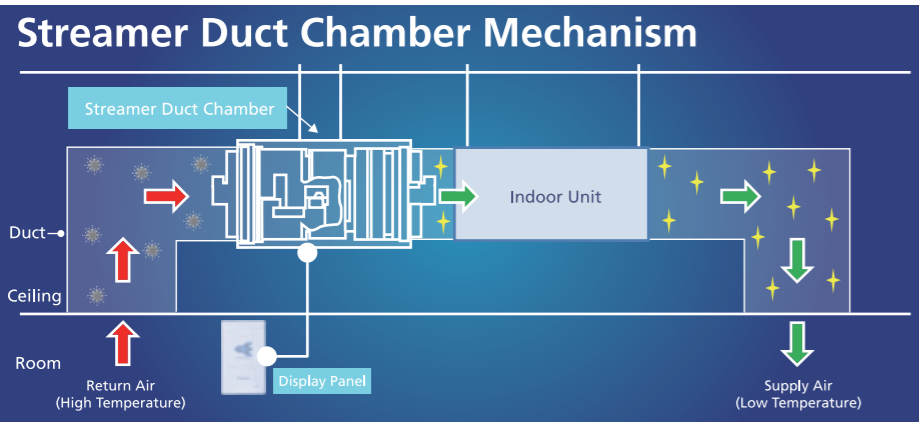

## Installation Conditions

### Duct Type Indoor Unit

Streamer Duct Chamber must be installed before the air conditioner unit to avoid condensation issue due to cold air draft.

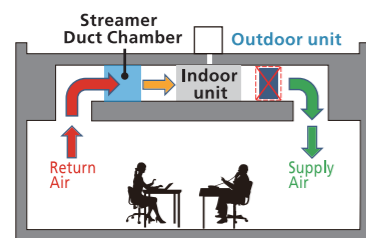

### Outdoor-Air Processing Unit

Streamer Duct Chamber must be installed before the air conditioner unit to avoid condensation issue due to cold air draft. Besides, it can avoid the outdoor-air processing unit from getting dirty with the outdoor polluted air.

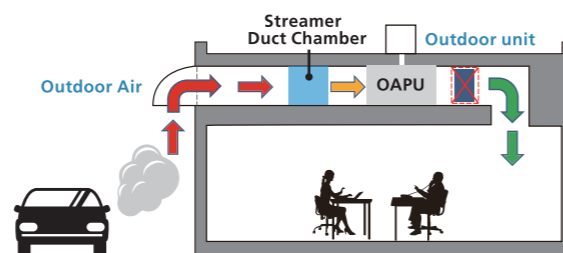

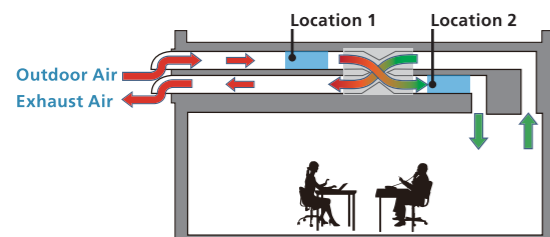

### Heat Reclaim Ventilator

Streamer Duct Chamber can be installed in either Location 1 or Location 2. However, Location 1 is highly recommended in order to avoid VAM from getting dirty with the outdoor polluted air.



## Specifications

MODEL	  		
	BDEZ500A60VE	BDEZ500A140VE	BDEZ500A510VE
Power supply	1 phase, 220-240 V/220 V, 50/60 Hz		
Casing dimensions	H (mm)	269	318
	W (mm)	419	1419
	D (mm)	418	653
Operating temperature	-10 to 50		
Operating humidity	Max. 80%RH		
Airflow rate	CMH	80 - 600	500 - 1400
Initial pressure drop	Pa	5 - 59	18 - 76
Dust collection filter (MERV 14) lifespan	Months (based on median CMH)	12	12
Weight	kg	13	38
Power consumption	W	6.0	11.0
Sound pressure level	No increase in Sound Pressure Level as overall system		
Filters quantity	Pre-filter	1	2
	Dust collection filter (MERV14)	1	2
	Deodorising filter	1	2
Replacement filter dust collection filter (MERV 14)		BAFH500A60 (1pc)	BAFH500A140 (2pcs)
Dimensions HxWxD	mm	221 x 392 x 50 (referring to 1pc only)	450 x 343 x 50 (referring to 1pc only)
Working method	DP sensor		

# Precision Piping Method

## A smarter way to connect refrigerant piping for VRF installations

Using TIGHTFIT (Daikin Gas Tight Joint) ensures safety, easy connection work and quick installation. In addition, heavy equipment, such as gas cylinders used for brazing, becomes unnecessary.

**TIGHTFIT**



**TIGHTFIT (Daikin Gas Tight Joint)**

- ✓ Easy installation by tightening with a wrench
- ✓ Metal seal to eliminate gas leaks
- ✓ Function to prevent insufficient nut tightening

**Non-Brazed REFNET Joint** New



- ✓ Non-Brazed connection
- ✓ Directly connects to Tightfit
- ✓ Insulation material conforms to British Standard fire protection

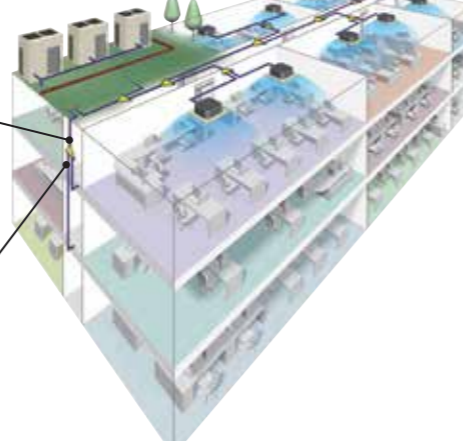

## Innovative problem solving for VRF refrigerant piping installation

**Shorter installation time**

Easy piping work significantly shortens installation time. This makes installation possible for projects with short deadlines while reducing labor costs.



**Safety for Fire**

Because no brazing is involved, installation is safe with no danger of fire. This makes it ideal for installation in renewal projects.



**Easy work**

- Torque for tightening nut is lower than the torque of the flare nut.
- Work can be safely performed even in high locations.
- Two wrenches are used to tighten pipe connection. (No special tools required.)

**Installation completed in 4 steps**

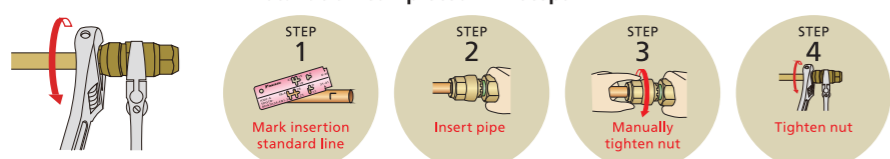

- STEP 1: Mark insertion standard line
- STEP 2: Insert pipe
- STEP 3: Manually tighten nut
- STEP 4: Tighten nut

Torque for tightening flare nut: 75Nm

Torque for Tightfit tightening: 19Nm

**LOW TORQUE** (75% reduction)

<φ15.9 copper pipe>



## Easy piping connection for residential installations

When installing a small-size VRF in a residential home, we suggest using a header pack to reduce construction and simplify installation. This also eliminates the need for heavy tools.

**HEADER PACK**



**HEADER PACK (Packaged Refnet Headers)**

- ✓ Time Saver using Quick Flare Nut Connection
- ✓ Compact design with low height
- ✓ Connects up to 4 and 6 indoor units

**Soft copper pipe**



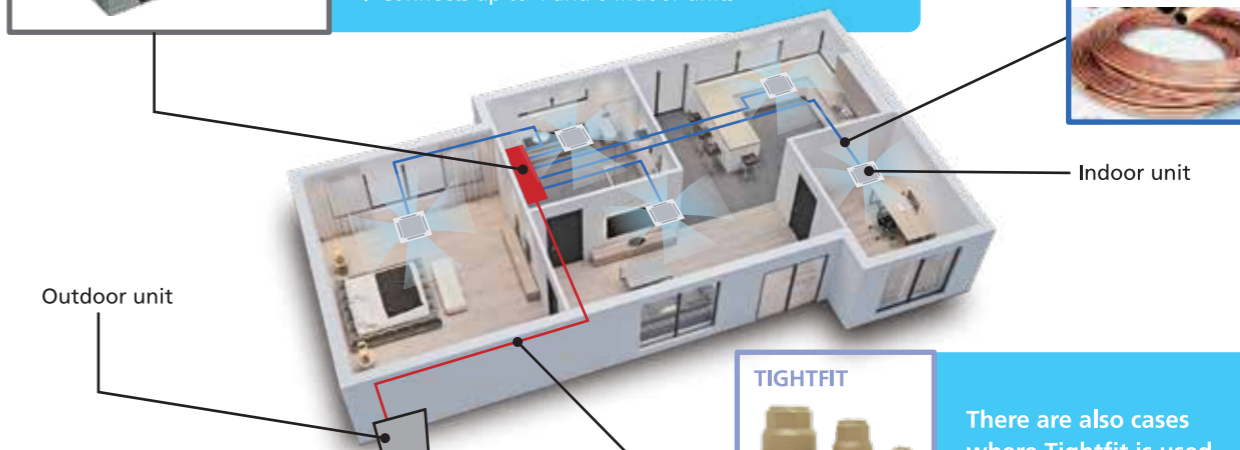

Outdoor unit      Indoor unit

**TIGHTFIT**



There are also cases where Tightfit is used.

**HEADER PACK**

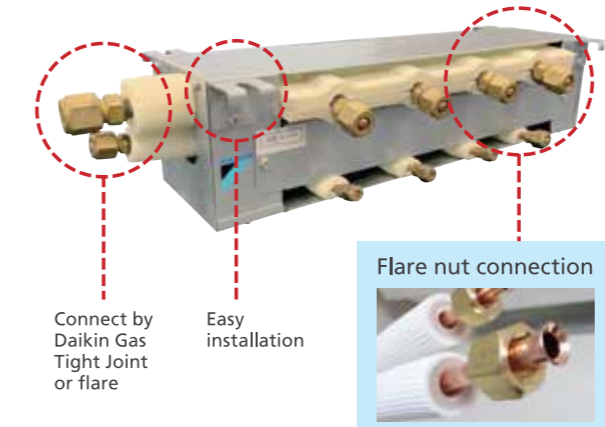

Connect by Daikin Gas Tight Joint or flare

Easy installation

**Flare nut connection**



**Refnet joint x5**

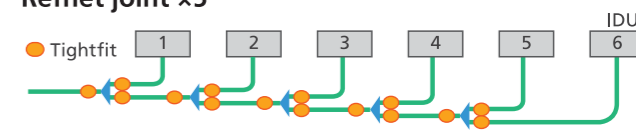

**HEADER PACK x1**

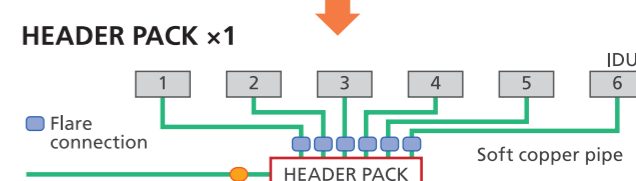

Flare connection      Soft copper pipe

**Benefits of Header Pack**

- Ideal for small-size properties and condominiums
- Fewer piping connections
- Flare connection makes it easy to connect
- Easy installation with substantial use of soft copper pipes (Good workability in high places and narrow spaces.)

**Easy connection**

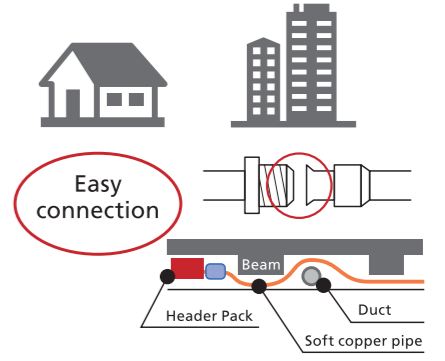

Beam      Duct      Soft copper pipe

# Precision Piping Method

## TIGHTFIT (Daikin Gas Tight Joint)

Easy to fit, tight connection

### Quality assurance

Conforms to ISO14903

Tightness test: P=4.3MPa;  
Test medium: 100% Helium, T=22°C  
Max leakage:  $7.5 \times 10^{-7}$  Pa·m<sup>3</sup>/s or less.  
Vacuum test: 6.5kPa in absolute

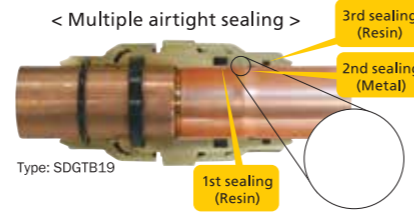

### TIGHTFIT full lineup

Standard Joint		Asymmetry Joint		90° Bend Joint		Test Plug	
Size	Model name	Size	Model name	Size	Model name	Size	Model name
ø6.35	SDGTB06	ø9.52-6.35	SDGTB0906	-	-	ø6.35	SDGTKB06
ø9.52	SDGTB09	ø12.70-9.52	SDGTB1209	-	-	ø9.52	SDGTKB09
ø12.70	SDGTB12	ø15.88-12.70	SDGTB1512	-	-	ø12.70	SDGTKB12
ø15.88	SDGTB15	ø19.05-15.88	SDGTB1915	-	-	ø15.88	SDGTKB15
ø19.05	SDGTB19	ø22.22-19.05	SDGTB2219	-	-	ø19.05	SDGTKB19
ø22.22	SDGTB22	ø25.40-22.22	SDGTB2522	ø22.22	SDGTLB22	ø22.22	SDGTKB22
ø28.58	SDGTB28	ø28.58-25.40	SDGTB2825	ø28.58	SDGTLB28	ø28.58	SDGTKB28
ø34.92	BDGTA34	ø34.92-28.58	SDGTB3428	-	-	-	-
ø41.28	BDGTA41	-	-	-	-	-	-

### Dimension & weight

#### Standard Joint

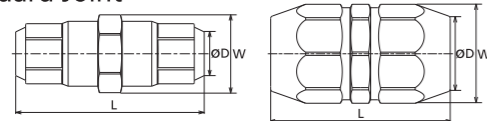

Size	L (mm)	W (mm)	Weight (g)
ø6.35	50.4	15.0	43.0
ø9.52	55.0	19.9	79.0
ø12.70	59.0	23.5	113.0
ø15.88	74.0	30.0	210.0
ø19.05	76.8	34.6	273.0
ø22.22	83.4	40.2	292.0
ø28.58	88.0	46.7	515.0
ø34.92	101.5	51.1	686.0
ø41.28	103.5	58.3	881.0

#### Asymmetry Joint

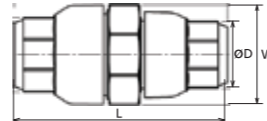

Size	L (mm)	W (mm)	Weight (g)
ø9.52-6.35	52.7	19.9	67.0
ø12.70-9.52	57.5	23.5	101.0
ø15.88-12.70	65.0	30.0	164.0
ø19.05-15.88	76.8	34.6	244.0
ø22.22-19.05	81.5	40.2	358.0
ø25.40-22.22	85.8	43.5	444.0
ø28.58-25.40	88.1	46.7	505.0
ø34.92-28.58	101.5	51.1	645.0

#### 90° Bend Joint

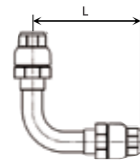

Size	L (mm)	Weight (g)
ø22.22	120.0	655.7
ø28.58	145.0	968.4

#### Test Plug

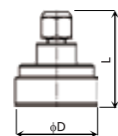

Size	L (mm)	W (mm)	Weight (g)
ø6.35	43.0	15.0	53.0
ø9.52	44.0	20.0	67.6
ø12.70	46.0	23.0	73.4
ø15.88	50.0	30.0	96.6
ø19.05	52.0	34.0	111.7
ø22.22	54.0	40.0	135.6
ø28.58	54.0	46.0	146.0

## New Non-Brazed REFNET Joint

Direct connection to TIGHTFIT

This kit is designed as a refrigerant branch kit for connecting the main and branch pipes of VRV indoor units without brazing.

### Lineup

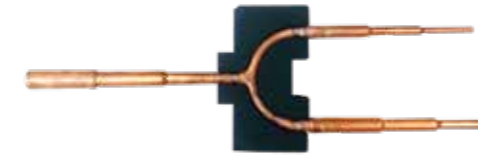

※ Insulation included

Indoor unit total capacity index	Model name	
	2 pipes	3 pipes
X < 290	BHRG26A33T	BHRG25A33T
290 ≤ X < 640	BHRG26A72T	BHRG25A72T
640 ≤ X	BHRG26A73T	BHRG25A73T

Case 1: If the pipe of the REFNET joint has the same size as the field pipe, cut it at the same size and connect it to the field pipe with the standard type of Daikin Gas Tight Joint.

Case 2: If the pipe of the REFNET joint has not the same size as the field pipe, use the Asymmetry joint (Reducer).

## HEADER PACK (Packaged Refnet Headers)

Simple & Quick Installation

### HEADER PACK Lineup

Model name	Outdoor unit side	Indoor unit side (Flare)		Indoor unit total capacity index	Dimension (mm)			
	Liquid / Gas (mm)	Port	Liquid / Gas (mm)		H	D	W	
BHF6RHP6Z	9.5 / 15.9 (Flare)	4	Large x1 Small x3	φ9.5 / φ 15.9 φ 6.4 / φ 12.7	≤ 150	135	143	559
BHF6ARHP6Z	9.5 / 15.9 (Flare)	6	Large x2 Small x4	φ9.5 / φ 15.9 φ 6.4 / φ 12.7	≤ 150	135	143	623
BHF8RHP6Z	9.5 / 19.1 (Daikin Gas Tight Joint)	6	Large x3 Small x3	φ9.5 / φ 15.9 φ 6.4 / φ 12.7	≤ 200	135	143	623
BHF10RHP6Z	9.5 / 22.2 (Daikin Gas Tight Joint)	6	Large x3 Small x3	φ9.5 / φ 15.9 φ 6.4 / φ 12.7	< 290	135	143	623
BHF16RHP6Z	12.7 / 28.6 (Daikin Gas Tight Joint)	6	Large x3 Small x3	φ9.5 / φ 15.9 φ 6.4 / φ 12.7	< 420	135	143	623



#### 90° Bend Joint BHF6RHP6Z Test Plug

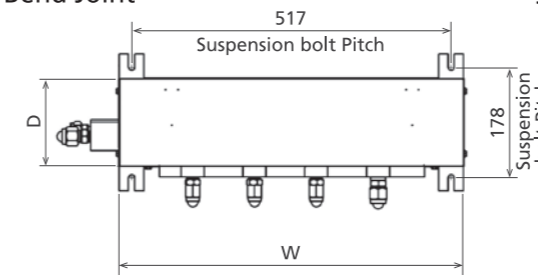

#### BHF6ARHP6Z, BHF8/10/16RHP6Z

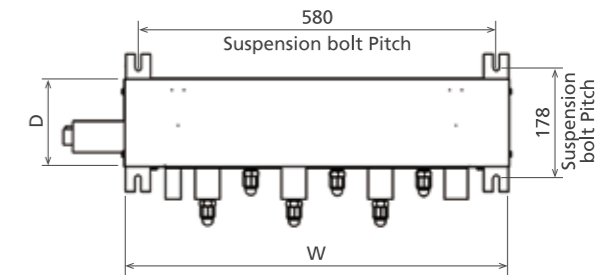

# Active Filter Unit

## BACF22E5 (Option) For VRV X (MAX) / A (MAX) series

In an electric power system, a harmonic is a voltage or current that is distorted and deviate from sinusoidal waveforms. The distorted waveforms occur from the composition of a frequency that is an integer multiple of the fundamental frequency of the power supply. Harmonics generated by power semiconductor devices can travel through wires and may have negative effects such as equipment malfunctions and damage, vibrations, strange noises, etc.

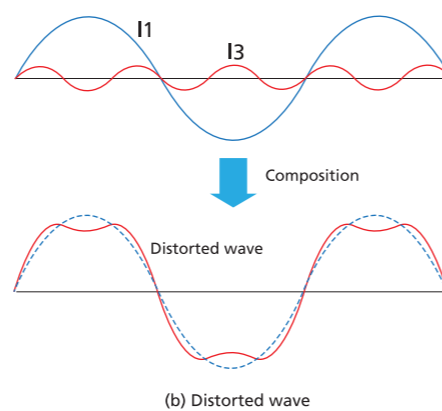
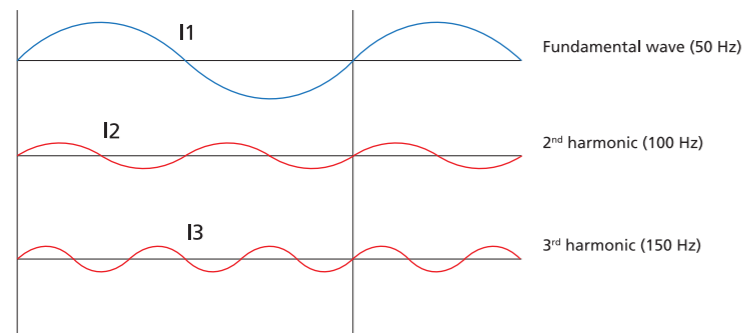

## Specifications

MODEL	BACF22E5	
Power supply	3 $\phi$ , 380 – 415 V/380 V, 50/60 Hz	
Rated compensation capacity	4.6 kVA	
Installation environment	Outdoors	
System	Cooling	Forced air cooling (built-in fan)
	Inverter	Voltage type
Operation	Load current: Starting 5.5 A or more, stopping 4.0 A or less	
Error display	Displayed on the display board when an error occurs	
Operation characteristics	Harmonic compensation target order: 2 <sup>nd</sup> to 23 <sup>rd</sup> However, the residual rate changes depending on the power supply impedance.	
Dimensions (HxWxD)	723 x 334 x 249 mm	
Weight	22 kg	

## Advantages of Active Filter

Daikin's Active Filter unit can drastically reduce harmonics, preventing damages from harmonics and extending equipment lifespan.

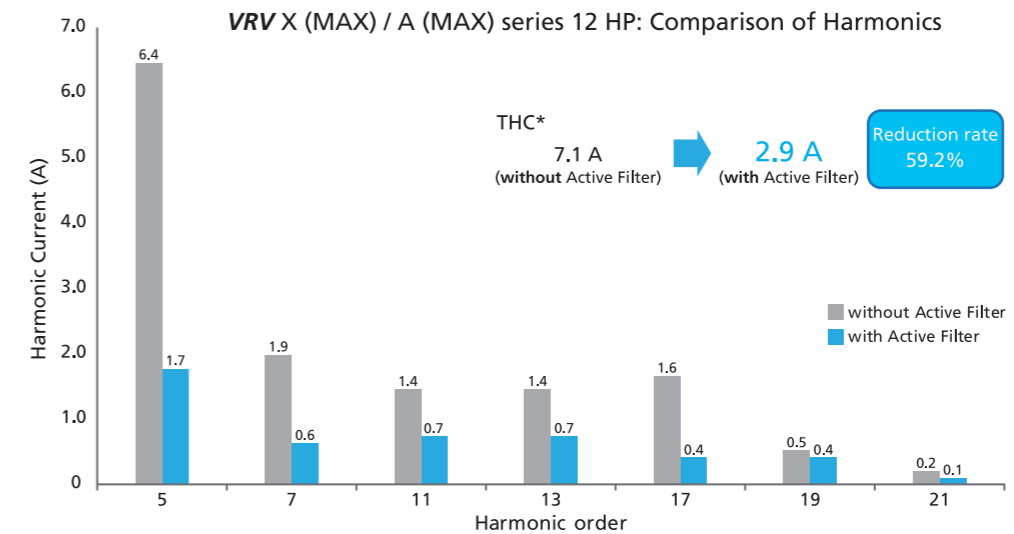

\*Total Harmonic Current (THC) is the accumulated currents of the orders 2 to 23 that contribute to the distortion of the current waveform. This value is particularly useful in determining the required characteristics for installation of modern active harmonic filters.

## Field Wiring

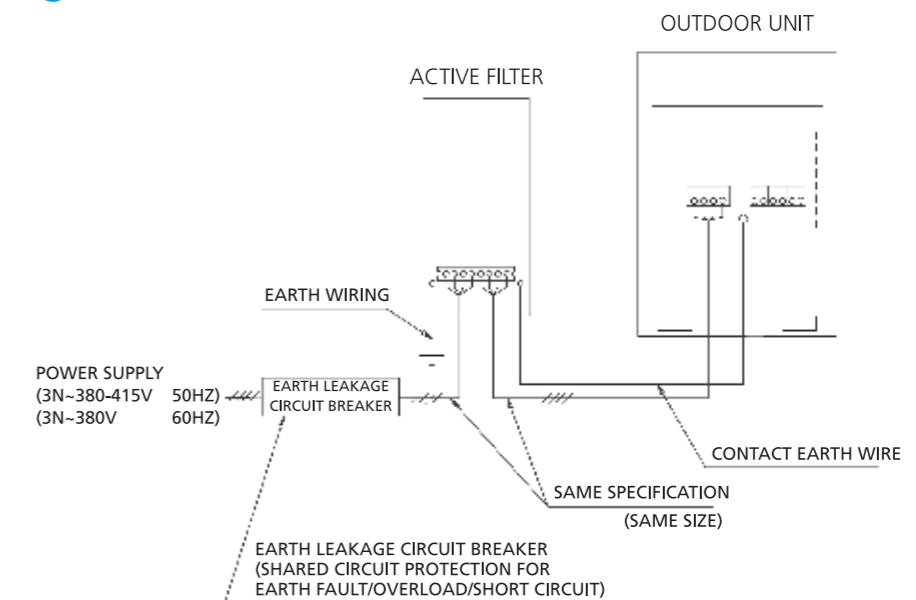

\* Refer to the Engineering Data Book for details.



Notes

Lined area for taking notes, consisting of 20 horizontal lines.